

**In the loving and inspirational memories of**

**Hon. Shri. Tatyasaeb Kore**

Shree Warana Vibhag Shikshan Mandal's

**YASHWANTRAO CHAVAN WARANA MAHAVIDYALAYA,  
WARANANAGAR**

Reaccredited with 'A' Grade (Third Cycle) by NACC  
Affiliated to Shivaji University. Kolhapur.

**Organizes**

**INTERNATIONAL CONFERENCE**

On

**‘ENERGY, ENVIRONMENT AND  
ETHICS IN RESEARCH’**

**(ICEEE-2019)**

**7<sup>th</sup> February 2019,**

Address: Alp- Warananagar, Tal. Panhala, Dist. Kolhapur 416113,  
Maharashtra, India. Ph. No : 02328 - 224041 E-mail Id :  
[ycwewarana@yahoo.co.in](mailto:ycwewarana@yahoo.co.in)

• PATRONS

**Hon. Dr. Vinayraoji Kore**

**President,**

Shree Warana Vibhag Shikshan Mandal, Warananagar

**Hon. Dr. Vasanti Rasam**

**Administrative Officer,**

Shree Warana Vibhag Shikshan Mandal, Warananagar

**CHAIRPERSON**

**Dr. Surekha Shahapure**

**Principal,**

Yashwantrao Chavan Warana Mahavidyalaya, Warananagar.

## **ADVISORY COMMITTEE**

- **Prof. JH Kim**, Chintan National University, South Korea
- **Prof. Yuan Ron-Ma**, National Dong Hwa University Ghalun, Taiwan, Prof. Ahmed Ennaoui, Helmholtz-Zentrum, Berlin, Germany
- **Prof. Neelkanth Dhere**, Florida, Solar Energy Centre, Florida, USA. Prof. Kei Noda, Keio University, Yokohama, Japan
- **Prof. C.K. Hong Chonnam** National University, South Korea
- **Prof. D. T. Shirke**, Pro. VC. Shivaji University, Kolhapur.

Prof. Mrs. S. H. Thakar

Prof. P. S. Patil

Prof. S. S. Chavan

Dr. Mrs. J. P. Jadhav

Prof. D. Harnath (AP)

Prof. M. M. Uplani

Prof. D. K. Gaikwad

Dr. M. V. Santakumar

Prof. Mrs. A. U. Arvindekar

Prof. G. S. Gokavi

Prof. V. J. Fulari

Prof. P. D. Raut

Dr. G. S. Kamble (Taiwan)

Dr. B. H. Patil (South Korea)

Dr. D. D. Shivgan (Delhi)

Dr. Sawanta Mali (South Korea)

Dr. J. S. Mali (South Korea)

Prof. S. I. Patil

## **ORGANIZING COMMITTEE**

- **Prof. M. G. Chikalkar - Organizing Chairman**
- **Dr. P. M. Bhoje - Convener**
- **Dr. S. Y. Jadhav - Co-convener**
- **Dr. B. S. Shirke - Secretary**
- **Dr. D. N. Bhosale - Joint Secretary**
- **Dr. S. J. Lade - Treasurer**
- **Mr. S. N. Golgire - Treasurer**
- **Mr. V. S. Patil – Editorial Chief**
- **Dr. S. S. Khot - IQAC Coordinator**

## **LOCAL ORGANIZING COMMITTEE**

- **Dr. U. B. Chikurdekar**
- **Dr. P. S. Raut**
- **Mr. M. N. Patil**
- **Dr. R. P. Kavane**
- **Mr. V. G. Sawant**
- **Dr. Mrs. P. R. Salokhe**
- **Dr. R. B. Patil**
- **Mr. U. D. Kadam**
- **Dr. A. R. Bhusnar**
- **Mr. S. M. Arde**
- **Dr. R. S. Pan day**
- **Mr. B. J. Ladgaonk**

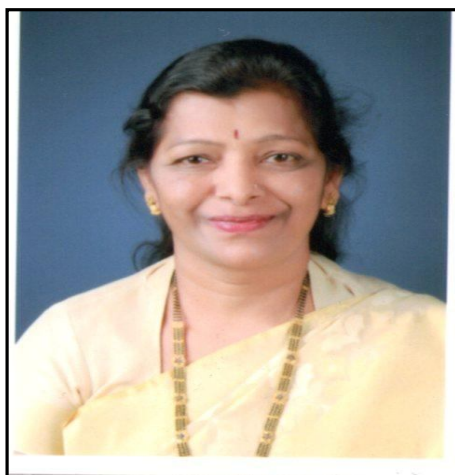

## Principal's Message...

Warm welcome to all delegates! It is my pleasure that you have visited my college to attend the International Conference on "Energy, Environment and Ethics in Research" which I believe, is a very pertinent issue in the present international and global system of governance. Some eminent scholars and scientists are participating in the deliberations of the conference some of them are,

- **P. Shahapur**, Professor, Chairman, Dean, P. G. Department of Studies in Education, Karnataka
- **Dr. Shivram Bhoje**, Padmashri Awardee, Former Director, IGCAR, Kalpakkam, DAE, Govt. of India,
- **Dr. Pravin Saptarshi**, Visiting Professor, Department of Env. Science, Salisbury University, USA. Emeritus Professor, Sustainability Management, Indian Inst. of Cost and Management Studies and Research, Pune.
- **Prof. Nagappa** University, Dharwad.
- **Prof. P. S. Patil**, Dean, Faculty of Science and Co-ordinator, School of Nanoscience, Shivaji University, Kolhapur.

Present their views on this important topic of the conference. I feel further happy that there are about 240 delegates who have registered their names for international conference and sent their research papers on interdisciplinary themes.

Our college is happy to organize, International Interdisciplinary Conference on 3E's : Energy, Environment and Ethics in Research , which aims to bring together Scientists, Engineers, Technologist, Researchers, Faculties of all disciplines around the globe to exchange their ideas, views, innovations in order to fulfill societal needs and aspirations.

It gives me great pleasure to publish the e-book as a result of the contribution of guests, resource persons, the delegates, teachers and students of science and technology in international Conference on the topic " Energy, Environment and Ethics in Research " organized by our college on 7th February 2019. I am confident that the publication will prove to be fruitful in the field of research of Energy, Environment and Ethics in Research. I am also sure that this research activity will be useful to the participants to carry out their further research in Energy, Environment and Ethics in Research effectively. I express sincere thanks to **Hon. Dr. Vinayraoji Kore** (Savkar), Chairman, Shree Warana Vibhag Shikshan Mandal, Warananagar and Ex. Minister of Horticulture and Non- Conventional Energy, Maharashtra State and **Hon. Dr. Vasanti Rasam Madam** , Administrative officer, Shree Warana Vibhag Shikshan Mandal, Warananagar for their guidance and help. I am indeed sure that this book as a result of international conference will help us to take a step forward in the march towards excellence in future.

I also thank editor of Aayushi, the international interdisciplinary, peer reviewed journal having ISSN number 2349- 638x, and impact factor 5.707. I wish the international conference a great success.



**Dr. Sou. S. B. Shahapure.**

Principal, Yashwantrao Chavan Warana Mahavidyalaya, Warananagar.

and Chairperson of ICEEE-2019,

Pin- 416 113,

Contact(o):02328-224041, 222820

Website: : [www.ycwm.ac.in](http://www.ycwm.ac.in)

E-mail Id : [ycwewarana@yahoo.co.in](mailto:ycwewarana@yahoo.co.in)

Mob. 9420931515.



## **Preface**

The place where a great visionary Late Tatyasaheb Kore created a paradise is Warananagar. It has become a well-known at National level as a Co-operative, Industrial and educational hub. Warananagar is a model village with cooperative movement, industry-educational complex and is the first wired village in India. Shree Warana Vibhag Shikshan Mandal was established by great visionary Late Shri Tatyasaheb Kore in 1964 to educate the students in the Warana Region with motto "Nava Manava Sakaru, Hach Shikshanacha Mahameru". It has been making a great impact on the minds of the youths and achieving its goals with rapid strides. At present 10,000 students are pursuing educations from KG to PG and 1100 employees working in this complex. The Mandal has huge eco friendly educational complex having different streams of educations such as technical, medicinal and fundamental.

Education is one of the key solutions for this situation. Ecology is being associated with the growth of any industry, organization. A nation's growth starts from its educational institutions, where the ecology is thought as a prime factor of development associated with environment. Educational institutions nowadays are becoming more sensitive to environmental factors and more concepts are being introduced to make them eco-friendly. To preserve the environment, to conserve the energy and deploy ethics is essential for the eco- balance.

We happy to organize, International Interdisciplinary Conference on 3E's : Energy, Environment and Ethics in Research on 7<sup>th</sup> February 2019 in our college , which aims to bring together Scientists, Engineers, Technologist, Researchers, Faculties of all disciplines around the globe to exchange their ideas, views, innovations in order to fulfill societal needs and aspirations. The main purpose of this International conference is to increase fruitful interactions amongst researchers about global issues of environmental concern which need immediate attention, the



search for alternative sources of energy and their generation with cost efficiency and feasibility, to make serious awareness about ethics to be followed by researchers and budding scientists.

I express my deep sense of gratitude to **Hon. Dr. Vinayraoji Kore** (Savkar), Chairman, Shree Warana Vibhag Shikshan Mandal, Warananagar and Ex. Minister of Horticulture and Non-Conventional Energy, Maharashtra State and **Hon. Dr. Vasanti Rasam** Madam , Administrative officer, Shree Warana Vibhag Shikshan Mandal, Warananagar for their guidance and help. I wish to extend my thanks to **Dr. Mrs. S. B. Shahapure**, Principal, Yashwantrao Chavan Warana Mahavidyalaya, Warananagar and teaching and non teaching staff of the college for their cooperation and timely help. Finally, I wish to express my sincere gratitude to all those who have helped me directly and indirectly in the completion of this e-book.

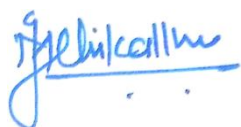

**Prof. M. G. Chikalkar,**

Organizing Chairman ICEEE-2019,

Head of Chemistry Department,

Yashwantrao Chavan Warana Mahavidyalaya, Warananagar.

Email Id:mgchikalkar@gmail.com

Mob. 9822548015



## Editor's Note...

Editorial Chief wishes to thank the participants who contributed to this issue and strengthen International Interdisciplinary Conference on 3E's : Energy, Environment and Ethics in Research on 7<sup>th</sup> February 2019 in our college that resulted in the grand success.

The term "Green" means eco-friendly or not damaging the environment. This can acronymic ally is called as "Global Readiness in Ensuring Ecological Neutrality" (GREEN). In scenario people are not caring of nature, they are directly or indirectly damaging the environment and it causes problems like; global warming, difficulties in maintaining ozone layers, air pollution, water pollution etc.

The major issues of environmental concern at global level comprise pollution, global warming, deforestations, waste disposal, ozone layer depletion etc. The major issues concerning fulfillment of energy needs of the globe compile exploration of new ways and means of other sources of energy such as solar energy, wind energy, nuclear energy, solid oxide fuel cell and so on. Good research demands research integrity, research design organizational governance, sharing research output, training, teaching and mentoring, promoting a positive research culture and maximizing the impact of research.

For protecting the nature as a human being we have to show our sense of humor towards the mother earth. In corporate sector the practice of saving environment through the various programmes like CSR (Corporate Social Responsibility), GO Green, Save Water, Save Trees, Plantation of trees are to be taken. It will definitely work for the future. That is the only way out to safeguard the planet.

As per the Energy Conservation Act, 2001, Energy Audit is essential and it is defined as "the verification, monitoring and analysis of use of energy including submission of technical report containing recommendations for improving energy efficiency with cost benefit analysis and an action plan to reduce energy consumption".

Education is the only tool which can inculcate ethics in research to protect environment and to conserve energy.

The *Special Issue* on International Interdisciplinary Conference on 3E's : 'Energy, Environment and Ethics in Research' which aims to bring together Scientists, Engineers, Technologist, Researchers, Faculties of all disciplines include Research areas within the scope of the subjects — Physics, Chemistry, Mathematics, Botany, Zoology, Electronics, Microbiology, Statistics and Geography, and applied topics of these subjects Sciences which tries to focus the versatile roles played on international conference theme. It invites scholarly views and demand society back to rethink on female competency.

I am delighted to know that the main theme of the international conference is really pertinent and the need of the hour for everyone. We received overwhelming response from all the

corners of the country. We had received about 80 papers of Researchers and students. Besides these papers we have also arranged invited talks by the experts in this field.

The research papers are classified as per language i.e. English, Marathi for the convenience of readers which covers the impact on 'Energy, Environment and Ethics in Research' at regional, national and international level and some remedy/solutions on it.

The researchers findings, their language, passage, his/her refusal to let the central theme of their work be ignored by slipping, even not duly attentive, stray from the main subject, their intentness to ferret out relevant materials – these and many more are the features of this *Special Issue* a topnotch piece of research, a mine of knowledge, a work brimming over with creativity.

It is pleasures for me to thank to **Hon. Dr. Vinayraoji Kore (Savkar)**, Chairman, Shree Warana Vibhag Shikshan Mandal, Warananagar and Ex. Minister of Horticulture and Non-Conventional Energy, Maharashtra State and **Hon. Dr. Vasanti Rasam Madam**, Administrative officer, Shree Warana Vibhag Shikshan Mandal, Warananagar for their guidance and help. I am especially grateful to our beloved Principal of our college, **Hon. Principal Dr. Mrs. S. B. Shahapure** for giving us constant encouragement and guidance for successful organization of this national seminar. I am also grateful to members in advisory board and members in organizing committee and all Faculty Members, Non-Teaching staff, students of the College without whose cooperation and hard work, the international conference would not have been successful.

Special thanks by our college to our publication partner **Mr. Pramod P. Tandale** of the Aayushi International Interdisciplinary Research Journal [Peer Review] gives e-book of this seminar in time.

I ones again extend my heartily welcome to all the participants and wish a fruitful time and most pleasant stay in Warananagar.



Mr. Vilas S. Patil  
Assistant Professor,  
Department of Physics,  
Yashwantrao Chavan Warana Mahavidyalaya, Warananagar.  
Email Id: vilaspatilkodoli@yahoo.in, vilaspatilkodoli2201@gmail.com

Mob. 9423282718

### **Disclaimer**

Research Papers / Articles published in this International Conference Special Issue are the intellectual contribution done by the authors. Authors are solely responsible for their published work. The organizer of this International Conference and Publisher of this *Special Issue No.48* are not responsible in any.

Sr.No.	Author Name	Title of Article / Research Paper	Page No.
1.	डॉ. सौ. सुरेखा बाळासाहेब शहापुरे	अनुसंधान में शक्ति, प्रकृति एवं नीति	1
2.	प्रा.डॉ.प्रकाश शंकरराव चिकुर्डेकर	हिंदी साहित्य में पर्यावरण के संदर्भ: एक अनुशीलन	3
3.	डॉ. सुर्यकांत लालचंद राठोड	उमरगा व लोहारा तालुक्यातील पाणलोट क्षेत्र विकास एक भौगोलीक अभ्यास	7
4.	प्राचार्य डॉ. प्रकाश पाटील	कृषी प्रदुषणाचा ग्रामीण जिवनावरील प्रभाव	10
5.	प्रा. अजितकुमार भिमराव पाटील	पर्यावरण व सार्वजनिक आरोग्य यांचा अभ्यास करणे	12
6.	Dr J K Dawle A S Bondge, K I Momin, V B Suryawanshi	Analysis Of Soil Samples From Various Places	15
7.	Arzoo G. Bagwan	Solid Waste Management In Municipal Corporation	17
8.	D. A. Lavate, V. J. Sawant, A. S. Khomane	Synthesis, Characterization Of Zno/Cdo Material Prepared By Chemical Bath Deposition Method	21
9.	Damini Powar	Nyctanthes Arbortristis: As A Natural Colorant In Drug Products	23
10.	Dr. Dinesh D. Satpute	Challenges In Environmental Ethics And Research Ethics	28
11.	Dipali Sable Anuradha Osawar	Occurrence Of Macrophytes In Godavari River In And Around Nanded –Waghala City, Maharashtra	31
12.	Dr. Prakash Soudagar Raut	The General Land Use Pattern In Perid Village: A Geographical Case Study	38
13.	Dr. Tilekar Sharad Balasaheb	Introduction To Wind Energy	41
14.	P D Mali, K C Mujawar	Study Of Rain Water Harvesting In Ray Nagar Kumbhari, Solapur, Maharashtra, India	43
15.	G.R. Nagargoje N. A. Kedar	Synthesis Of New 4-Substituted Amino Pyrdo [2, 3-D] Pyrimidine Derivatives Under Solvent- Free Conditions	48
16.	R. A. Andhare	Biodegradation Of Keratin By Bacillus Licheniformis	53
17.	R. N. Jadhav	Use Of Medicinal Plants On Antibiotic Resistant <i>Bacillus Cereus</i> Isolated From Cooked Rice In Latur City	56
18.	Rajmati Patil	Physicochemical Analysis Of Agricultural Soil Quality Parameters In Patan Tahasil, State- Maharashtra	59
19.	Rohini Kamble, M. V. Sutar, T. V. Sathe And S. S. Patil	Study Of Physico-Chemical Water Parameter Of Bhogavati River, Kolhapur, India	61
20.	S.H. Mane, B. S. Kamble	Impact And Assessment Of Sewage Discharge On Water Qualities Around Municipal Sewage	65
21.	Mr. Achut Ramrao Shinde Dr. D.B. Muley Mr. Abhay S. Bondge	A Brief Review On Various Synthetic Aproches Of Biologically Active Nitrogen & Sulphur Containing Spiro-Heterocycles.	70
22.	Smt. Mangal Vijay Gaikwad	Bayesian Model For Ecological Balance Of Environment	75

23.	A.V. Mali, G. B. Dhake R.S. Patil	Structural, Electrical Properties Of MG Substituted MN Ferrite By Sol-Gel Method	77
24.	D. B. Rane	The Cosmos & The Laws Of Physics	81
25.	J K Dawle, A S Bondge, K I Momin, V B Suryawanshi	Theoretical Basis Of Soil Analysis	83
26.	R. M. Ovhal, R.A. Pawarb And K. D. Gaikwada	Photoelectrochemical Studies On Chemically Deposited Cd1-Xpbxse Thin Film	85
27.	Rahul S. Patil	Eco-Friendly Protocol For Synthesis Of Bisindolylmethane	91
28.	S. P. Patil, A. R. Dighe, H. K. Jadhav	Impact Of Domestic Activities On Water Quality Parameters Of Kasari Freshwater Tank, Tal-Shahuwadi, Dist- Kolhapur (M.S.), India.	95
29.	Smita S. Giria, Prabha R. Salokhe	Phyto-Chemical, Nutritional Screening & Antibacterial Activity Of Custard Apple (Annona Squamosa L.) Seeds Extracts On E-Coli	97
30.	M. R. Shinde	Air Borne Deteriorating Fungi Inside The Libra Koyana Nagar ,M.S.	100
31.	Dr. S.G. Jambhale Mr. V.G. Sawant Dr. J. S. Jambhale- Patil	Ethics In Research: An Introduction	103
32.	Rajaram S. Sutar , Vishnu S. Kodag , Nikhil N. Pargaonkar , Akshay R. Jundle, Nilam B. Gharge , Shrutika S. Kshirsagar, Narayan P. Kulkarni , Susmita S. Kanchankoti, Akshata S. Sawant , Prashant S. Yadav , Rutuja S. Gadade , Monika M. Patil , Varsha N. Patil , S. R. Kulal , A. K. Bhosale And Sanjay S. Latthe	Self-Cleaning Superhydrophobic Coating By ODS Modified Silica Particles	105
33.	Dr. Mrs. Snehal Makar Rajhans	Women Empowerment By Self Help Groups (Shgs): A Case Study Of South West Villages Of Walwa Tehasil , Sangli District (Maharashtra)	108
34.	Suresh V. Ingale	Climate Change And Its Impact On Agriculture	114
35.	Dr. Pravinchandra D. Bhakare	Population Resource And Demographic Transition In India	118
36.	Prof. V.G. Sawant	Assessments Of Drinking Water Quality Of Ichalkaranji City And Suburban Area Of Kolhapur District In Maharashtra State: A Geographical Inquiry	121
37.	Kumbar S. R Dr. Chetan Jarali Dr. D.B.Talange	Materials Used For Microbial Fuel Cell	126

38.	Milind G. Chikalkar Vilas. Shamrao Patil	Advanced Ncs Devices For Smart Lighting Purposes A New Way Of Energy Saving	129
39.	Vilas Shamrao Patil	Structural &Optical Studies Of Nanocrystalline Cds Thin Films For Energy Saving Applications	134
40.	Chandrakant Balu Mane Vilas Shamrao Patil	Strctural, Microstructural Characterization & Electrical Transport Studies Of Nano Cds For Nano Electronic Applications	139
41.	Vilas. Shamrao Patil Avinash Ladgonkar	Nanocrystal Devices (Light Emitting Devices And Plasmonics) For Electric Energy Conservation Applications	144
42.	Ms. Rohini Patil, Mr. Patil Vilas Shamrao	Voltage Measurement Using Digital Voltmeter For Different Electrical Appliances: Power Saving By Vhdl Language	150
43.	U. D. Kadam, B. S. Shirke, S. M. Arde, R. S. Pandav	Energy Dispersive Analysis Of X-Rays (Edax) An Ideal Tool For Elemental Mapping Of Mixed- Metal Oxides Synthesized By Sol-Gel Method	153
44.	P.P.Pujari	Evaluation Of The Underground Water Quality From Various Regions Of Kolhapur City	156
45.	B.S. Shirke , A.A. Kabure , M.G. Chikalkar, S.R. Mane And K.M. Garadkar	Adsorption Of Rhodamine B From Aqueous Solution Onto Low-Cost Cerium Oxide Nanoparticles	160
46.	B.P.Tingare	Fauna Of Amphibia From Poladpur Tehsil, Western Ghats, Maharashtra, India,	165
47.	Dr. Janardhan K. Mane Mahesh S. Wavare	A Comparative Analysis Of Mathematical Linear Programming Problem	167
48.	Prabha R. Salokhe	A Comparative Study Between Chemical And Biocatalytic Reduction Of Prochiral Ketones	174
49.	R.R. Patil A.C. Jadhav J.G. Mangule, S. S. Shaikh, S.R. Patil, A.A. Jog And N.H. Shaikh	Tobacco Induced Alteration In The Mantle Of Terrestrial Molluscs <i>Leveculusalte</i>	177
50.	Dr. D. N. Bhosale, Dr. S. J. Lade	Ethics In Scientific Research	181
51.	Sonali Patil, Pournima Kore, Nikita Patil	Paper Batteries Using Carbon Nanotube - Coated With Conventional Sheet Of Cellulose-Based Paper	183
52.	Dr. Nagappa P. Shahapur,	Ethical Considerations In Conducting Research	188
53.	P. M. Bhoje K.M. Charaple, & Bhusnar A. R.	The New Record Of <i>Apentels Papiliones</i> (Hymenoptera: Braconedae) As A Biocontrol Agents Of Lime Butterfly <i>Papilodemoles</i> (Lepidoptera: Papilionidae) From Warnanagar, Western Maharashtra	193
54.	Dr. Sanjay Y. Jadhav	Role Of Botany In Climate Change By In-Situ Conservation Of Plants	195
55.	Raghunath R. Chavan	Skills For KM In Library And Information Science.	198
56.	A.D. Nigade, Dr. P.J. Patil, Dr. A.S. Todkar	Experimental And Fe Analysis For Comparative Bending Stress Analysis Of Cosine Gear And Involute Spur Gear	200

57.	A. R. Bhusnar & P.M. Bhoje	Studies On Insect Biocontrol Agents From Kolhapur Districts Of Western Maharashtra, India	205
58.	Bharat Misal	Effect Of Seaweed Liquid Fertilizer Of <i>Caulerpa Taxifolia</i> On Pigment Concentration Of Fenugreek	210
59.	Dr. A. B. Patil, A.D. Patil, Dr. S. M. Patil	Green Approach Of Spent Wash To Decrease The Dose Of Fertilizer Quantity For Soil In Village Dholewadi From Shirala Tahasil	214
60.	Dr.Pore Sanjay Vishnu	Impact Of Climate Change On Agricultural Productivity Productivity In Kadegaon Tehsil Of Sangli District (M.S.) India.	218
61.	Prabhakar Kute, Nandkishor Chaudhari	Role Of Nanotechnology To Control And Prevent Air And Water Pollution: A Bird's Eye View	221
62.	S. N. Golgire M. S. Bapat	Qualityof Milk In Dairy Plant By Fuzzy Control	226
63.	S. S. Patil D. B. Patil	Relativistic Magneto – Dust Distribution And A Group Of Conharmonic Conformal Motions	231
64.	Satish Patil H. K. Jadhav	Biodiversity Of Aquatic Animals Alni Dam At. Alnigaon, District Osmanabad Maharashtra India	234
65.	Miss. Supriya P. Kusale Dr. Yasmin. C. Attar	Effect Of Liquid Biofertilizer On Maize ( <i>Zea Mays L.</i> ) Production- Agronomical Tool For Sustainable Environment	237
66.	Uttam Kadam, Mahesh Magdum, Suraj Patil, Prasad Kulkarni, Aniket Gaikwad, Satyanarayan Arde	Recovery Of Multi Applicative Copper Metal From Silver Jewellery Laboratory Effluent And Antibacterial, Fungicidal Activity Of Effluent Modified Standard Copper Sulphate	242
67.	Vikas D. Sonawane, Babasaheb D. Sonawane, Dipak P. Hiwarale And Raghunath B. Bhosale	Design, Green Synthesis, Characterization And Antifungal Evaluation Of Novel Fluoro Imidazo [1,2-A] Pyridine Chalcones	246
68.	Vilas S. Patil Manisha V. Patil	Sustainable Development, Enhance In Environment And Green Economy With Gender Equality	252
69.	प्रा. आर. यू. चोचंडे	जलसंधारन कळाची गरज	261
70.	प्रा . प्रज्ञा जे . कांबळे - शिरगांवकर	हवा आणि पाणी प्रदुषण	264
71.	प्रा. भीमराव खं. वानोळे	तळ ढळताना या काव्यसंग्रहातून अभिव्यक्त झालेल्या पर्यावरणविषयक जाणिवा	268
72.	B.P.Tingare	Fauna Of Amphibia From Poladpur Tehsil, Western Ghats, Maharashtra, India	271
73.	A.R.Padule, I. F. Pailwan and V.D.Gaikwad	Assessment of Physicochemical Parameters of Three Hill Streams in Patan Tehsil,Satara District (M. S.) India	273
74.	Prof. Dr. Purnima Pattanshetti	Ethics in Research	279

## अनुसंधान में शक्ति, प्रकृति एवं नीति

डॉ. सौ. सुरेखा बाळासाहेब शहापुरे,  
प्राचार्या,  
य. च. वारणा महाविद्यालय,  
वारणानगर .

आंतरराष्ट्रीय अनुसंधान के लिए अनुसंधाताओं को एक अच्छा अवसर प्राप्त हुआ है कि एक नये एवं मौलिक विषय पर शोधनिबंध प्रस्तुत करें | अनुसंधान कर्ता को शक्ति अर्थात ऊर्जा प्राकृतिक संतुलन के द्वारा ही प्राप्त होती है | मनुष्य में प्रकृति संतुलन स्वास्थ्य बनाए रखता है | अच्छा स्वास्थ्य ही अध्ययन एवं अनुसंधान के लिए प्रेरित करता है | इतना ही नहीं उसे नैतिकता भी प्रदान करता है | मनुष्य की नैतिकता ही दूसरों की सेवा, सहानुभूति एवं उनके कल्याण के लिए सिद्ध हो जाती है | मौलिक अनुसंधान शक्ति, प्रकृति एवं नीति की सहायता से ही संभव बन जाता है |

मनुष्य का विकास प्राकृतिक परिवेश का ही परिणाम है | हमारे शरीर और संस्कारों में प्राकृतिक परिवेश के गुणधर्म अपनी पूरी सूक्ष्मता में समाए हुए हैं | पंचतत्वों से रचित हमारे शरीर में प्राकृतिक पाँच तत्वों का ही अभिन्यास है | मनुष्य की अस्वस्थता का सबसे बड़ा कारण इन प्राकृतिक तत्वों में होने वाले असंतुलन को माना गया है | यही कारण है कि प्राकृतिक असंतुलन का असर तत्काल हमारे शरीर, मन और मस्तिष्क पर पड़ता है |

हमारा जीवन प्रकृति की क्रोड में ही पालित, पोषित और विकसित हुआ है | इसलिए प्रकृति से जीवन अभिन्न नहीं है | हमारी प्रमुख संवेदनाएं प्रकृति के साथ ही क्रियाशील होती है | जीवन की प्रायाः सभी आवश्यकताएँ प्रकृति के माध्यम से ही पूर्ण होती हैं | वैदिक ऋषि ने भी पर्यावरणीय महत्व को जान लिया था | अतः वह कहता है □माता पृथ्वी पुत्रोऽस्य प्रथित्याः□ अर्थात् पृथ्वी हमारी माता है और हम पृथ्वी के पुत्र हैं | अधिक से अधिक प्रकृति की सुरक्षा और अधिक से अधिक प्रकृति से सहयोग ही विश्व मानव के विकास का पथ प्रशस्त करने वाले तत्व हैं | विश्वमानव का विकास अनुसंधान के लिए प्रेरक बनता है | पर अनुसंधान में भी नैतिकता का सहारा लेना भी आवश्यक बन जाता है | नैतिकता या नीति की चर्चा विदूर नीति, चाणक्य नीति, पराशर नीति से लेकर पॉलिटिक्स इथिक्स ऑफ पॉलिटिक्स स्टेट्स मैन आदि राजनीतिक संबंधित ग्रंथों में हमें प्राप्त होती हैं | नीति मानव जीवन की संचालिका है | नैतिकता मानव जीवन के अभ्युदय और आनंद सर्व प्रथम संस्थान होने से जीवन के नानाविध रूपों को स्पर्श करती है |

नीति लोक या समाज के कल्याण के लिए उचित ठहराया हुआ आचार व्यवहार है | नीति व्यवहार की वह रीति है, जिससे अपना कल्याण हो और समाज को भी बाधा न हो | नीति आदर्श आचार के रूप में द्रष्टव्य है | आदर्श जीवनयापन नीति है | शक्ति, प्रकृति तथा नीति अनुसंधान में एक-दूसरे के सहायक बने हैं | हर एक अनुसंधाता के अनुसंधान में ये तीनों बातें अनिवार्य हैं | अतः अनुसंधाताओं ने मानव हित को ध्यान में रखकर ही आविष्कार किये हैं, जो भारत ही नहीं पूरे विश्व को बदल देने में उपयोगी सिद्ध बने हैं | पहिया मनुष्य का सबसे बड़ा आविष्कार रहा है | ईसा से लगभग ३००० वर्ष पहले किसी चतुर आदमी ने इस सीधी साधी वस्तु का आविष्कार किया जो की आज हर जगह और हर काम में मनुष्य का सबसे आवश्यक उपकरण बन गयी है □

मनुष्य के समुचे इतिहास में यातायात के साधनों में जो सबसे बड़ा आविष्कार हुआ वह पहिये का आविष्कार था | दूसरा आविष्कार भाप की शक्ति का था | भाप की शक्ति को काम में ला सकना यह मनुष्य की एक बहुत बड़ी विजय रही है | मनुष्य को हमेशा से अधिक रफ्तार और अधिक शक्ति की तलाश रही है, और उसकी यह तलाश ही उसे भाप की शक्ति की खोज तक ले गयी है | मायक्रोस्कोप एवं मुद्रण भी मनुष्य के वैज्ञानिक आविष्कार रह चुके हैं | मनुष्य ने हजारों आविष्कार किये हैं, पर इनमें से कुछ सचमुच बुनियादी आविष्कार हैं | जो मनुष्य के रहन-सहन के तरीकों में परिवर्तन उत्पन्न करते हैं □



प्राचीन भारत के वैज्ञानिकों में धन्वंतरी शास्त्रीय भारतीय चिकित्सा शास्त्र के देवता थे और अभी भी उनका नाम पर्याप्त सम्मान और श्रद्धा के साथ लिया जाता है | आज भी यदि आयुर्वेद का कोई चिकित्सक इस क्षेत्र में उच्चतम एवं पूर्ण ज्ञान प्राप्त कर लेता है, उसे कभी-कभी धन्वंतरी की उपाधि से सुशोभित किया जाता है |

चरक संहिता के एक पौराणिक गाथा में वर्णन है की ऋषि भारद्वाज ने इंद्रदेव से किस प्रकार आयुर्वेदिक चिकित्सा ज्ञान प्राप्त किया और तत्पश्चात उस ज्ञान को अन्य ऋषियों में प्रतिपादित किया | जीवक महात्मा बुद्ध के चिकित्सक थे तो आत्रेय आयुर्वेदिक चिकित्सा शास्त्र के विख्यात अध्यापक थे | पतंजली योग विद्या के प्रणेता चरक भी प्रसिद्ध चिकित्सक रहे हैं | चरक के औषधशास्त्र में मुख्यतः वनस्पती पदार्थों का समावेश है | मुश्रुत को शल्यचिकित्सक माना जाता है | वाग्भट्ट भी एक महान चिकित्सक थे, माधवकर रोगविषयक निदान शास्त्री थे | आर्यभट्ट गणित के प्रकांड पंडित थे |

संसार के महान वैज्ञानिकों ने भी अनुसंधान में अपना विशेष योगदान दिया है | क्लॉपरनिकस कई विद्याओं के ज्ञाता थे | विशेषकर गणित और ज्योतिष को उन्होंने अपना सूर्य केंद्रीय सिद्धांत निकाला तो सारे जगत में तहलका मच गया | कोई ये मानने को तैयार ही नहीं था की पृथ्वी अपनी कीली पर घूमती हुई सूर्य के चारों ओर चक्कर लगाती है |

गैलीलियो गैलिली एक दूरदर्शक यंत्र का आविष्कार किया | इसी यंत्र से उन्होंने एक दूरदर्शक यंत्र का आविष्कार किया | इसी यंत्र से उन्होंने आकाश के अज्ञात रहस्य की खोज की | उसने सूर्य और चंद्रमा पर धब्बे बतलाए | जॉन कैपलर के गुरु थे ट्राइकोवाही इन्होंने सबसे पहले सूर्यग्रहण, चंद्रग्रहण तथा चंद्रकला का पता लगाया फिर जॉन कैपलर के गुरु के साथ सूर्य और ग्रहों की चाल का अध्ययन किया | सर आईजक न्यूटन के गुरुत्वाकर्षण शक्ति को खोज निकाला | कुछ समय पश्चात गणित की नई शाखा चलन कलन को खोज निकाला | एक तपस्वी वैज्ञानिक का नाम था रोजन जिसने एक्स किरणों की खोज की | सर्जरी में इसे काम में लाया जाता है | इसके साथ ही शरीर के अंगों का छायाचित्र, कैंसर का इलाज, इंजिनियरिंग आदि में काम आती है | डार्विन के जाति की उत्पत्ति नामक पुस्तक लिखी | डार्विन का कहना था कि कोई दो जीव समान नहीं हैं जो जीव पृथ्वी पर प्रकृति से संघर्ष न कर सकेंगे वह जल्दी मर जायेंगे |

लुई पास्तोर बताया था कि रोगों का कारण छोटे-छोटे किटाणु होते हैं | यदि इन किटाणुओं को नष्ट कर दे तो रोग भी भाग जाता है | विंजामिन फ्रेंकलिन पता लगाया था की बादलों की बिजली में भी वैसी ही ताकद है जैसे घर की बिजली में होती है | प्रफुलचंद्र रे रसायन विज्ञान में खोज कार्य करते हुये अमोनियम नाइट्राइट की खोज कर डाली थी | सर जगदिश चंद्र बोस ने बिजली के तार यंत्र सबको दिखाया था | उन्होंने विज्ञान की एक शाखा वनस्पती विज्ञान में एक नई खोज की | उन्होंने बताया कि पेड़ पौधे भी हमारी तरह साँस लेते हैं | पौधों को भी हमारी तरह चोट लगने पर दुःख होता है, जब खुशी की बात होती है तो पौधे भी खुश होते हैं |

इन सारे अनुसंधान की बुनियाद में नीति काम करती है | जो नीति केवल जनता के कल्याण के हेतु काम करती है | नीति को बनाए रखने के लिए प्रकृति का साथ जब मिलता है तभी मनुष्य को अच्छा कार्य करने की प्रेरणा मिलती है | इसी प्रेरणा या शक्ति के कारण वैज्ञानिक नये-नये आविष्कार कर डालते हैं | जिससे मानव कल्याण ही नहीं विश्व कल्याण हो जाता है |

संदर्भ : □

- 1 . मीर नजाबत अली □ विश्व को बदल देनेवाले आविष्कार □ नेशनल बुक ट्रस्ट, इंडीया, नई दिल्ली . पृष्ठ □ 5 .
- 2 . इर्विंग रबिन □ दुनिया के आविष्कार □ शिक्षा भारती, दिल्ली . पृष्ठ □ 7 .
- 3 . ओ . पी . जग्गी □ प्राचीन भारत के वैज्ञानिक एवं उनकी उपलब्धियाँ □ आत्माराम अँड सन्स, दिल्ली . पृष्ठ □ 30 .
- 4 . श्रीमती लभा भार्गव □ संसार के महान वैज्ञानिक ज्ञान □ विज्ञान प्रकाशन, लखनऊ . पृष्ठ □ 20 .

## हिंदी साहित्य में पर्यावरण के संदर्भ: एक अनुशीलन

प्रा.डॉ.प्रकाश शंकरराव चिकुर्डेकर,  
सहयोगी प्राध्यापक एवं शोध निर्देशक,  
शिवाजी विश्वविद्यालय कोल्हापुर संलग्न  
हिंदी विभाग,  
यशवंतराव चव्हाण वारणा महाविद्यालय,  
वारणानगर, जिला- कोल्हापुर (महाराष्ट्र)

## प्रस्तावना-

‘पर्यावरण’, शब्द के लिए अंग्रेजी में ‘एनवायरमेंट’, कहा जाता है। ‘पर्यावरण’ शब्द का निर्माण दो शब्दों से मिलकर हुआ है। ‘परी’, जो हमारे चारों ओर है ‘आवरण’, जो हमें चारों ओर से घिरे हुए है। पर्यावरण उन सभी भौतिक रासायनिक एवं जैविक कारकों की समस्तीगत इकाई है जो किसी जीवधारी अथवा पारितंत्र आबादी को प्रभावित करते हैं तथा उनके रूप, जीवन और जीविता को तय करते हैं। हमारे चारों ओर व्याप्त जीवन की प्रत्येक घटना इसी पर्यावरण के अंदर आती है। हम मनुष्य अपनी समस्त क्रियाओं से इस पर्यावरण को भी प्रभावित करते हैं। इस प्रकार एक जीवधारी और उसके पर्यावरण के बीच एक अनन्य साधारण संबंध है।

पर्यावरण के जैविक घटकों में सूक्ष्म जीवाणुओं से लेकर कीड़ेमकोड़े, सभी जीव जंतु और पेड़पौधे आ जाते हैं और इसके साथ ही उनसे जुड़ी सारी क्रियाएं और प्रक्रिया भी आती है। जीवन सत्व और उनसे जुड़ी प्रक्रिया पर्यावरण के अंदर आती है। जैसे चट्टानें, पर्वत, नदी, हवा, जलवायु के तत्व आदि। पर्यावरण शब्द में सारा ब्रह्मांड समा जाता है। अर्थात् हम सभी तथा हमारा सारा संसार, आकाश, वायु, जल, पृथ्वी, अग्नि, वन, वृक्ष, नदी, पहाड़, पर्वत, मानव, वन्य जीव, जंतु, वृक्ष, नदियां और सभी ऋतु हैं। परस्पर एक दूसरे से जुड़े हैं तथा पर्यावरण के अभिन्न अंग भी है। पुरातन युग में सन्यासी लोग वन केंद्र ही हुआ करता था। वानप्रस्थ आश्रम भी उसे कहा जाता था जो कि पारिवारिक जीवन का एक हिस्सा ही था। ‘समस्त तत्व तथा पदार्थों का समग्र रूप जो बनता है वह पर्यावरण है।’ उसी में से सब पैदा होते हैं, जीवित रहते हैं, सांस लेते हैं, फलते- फूलते हैं और अपने समस्त कार्य कलाप समाप्त होने के बाद इसी संसार में समाहित हो जाते हैं। प्रकृति के इन पांच तत्वों से मिलकर ही मानव शरीर की रचना हुई है। इसी प्रकार तुलसीदास से लेकर आज तक के अनेक लेखक-कवियों ने समस्त हिंदी साहित्य को एक व्यापक रूप में ‘पर्यावरण’ को लेकर अपने शब्दों में बद्ध कर दिया है।

## प्राचीन से आधुनिक काल तक : ग्रंथों में पर्यावरण के संदर्भ:-

हिंदी साहित्य में पर्यावरण को लेकर बहुत सारे संतों ने और लेखक महानुभावों ने अपनी अपनी रचनाओं में बहुत कुछ अलग - अलग विषयों को लेकर लिखा है। महान संत कवि सगुण धारा राम भक्ति शाखा के प्रतिनिधि तुलसीदास जी ने अपनी महानतम कृति ‘रामचरितमानस’ के किष्किंधाकांड में लिखा है कि मनुष्य का शरीर भी प्रकृति के पांच तत्वों से मिला है। पृथ्वी, जल, पावक, गगन और समीर से मिलकर बना है। वह लिखते हैं- ‘छिति जल पावक गगन समीरा पंच रचित अति अधम सरीरा’<sup>1</sup> वैदिक काल से लेकर आज तक के अध्ययन से पता चलता है कि तत्कालीन भारतीय समाज व्यवस्था में प्रकृति की पूजा की जाती थी और आज भी की जाती है। उनके लिए पृथ्वी अर्थात् धरती माता के समान है। उसकी रक्षा के लिए वह प्रयत्न करता नजर आता है। वह अपने कर्तव्यों का पालन करता है लेकिन आधुनिक काल और विज्ञान की प्रगति ने इस धरती मां को बर्बादी की ओर ले जाने की कोशिश की है। वैदिक युग के लोगों ने तुलसी, बरगद, पीपल, आम, कदंब आदि की पूजा की है। भक्तिकाल के संत कवि तुलसीदास, सूरदास, कबीर, जायसी, मीरा, रहीम के साथ-साथ संत रविदास जी ने अपने समग्र साहित्य द्वारा भारतीय जनमानस को पर्यावरण के प्रति जागृत कर पर्यावरण सुरक्षित रखने के लिए कोशिश की है। रविदास जी ने मनुष्य के मन का, पवित्रता का, संबंध मां गंगा नदी के साथ जोड़ दिया है। उनका कहना है ‘मन चंगा तो कठौती में गंगा।

आदिकाल, भक्तिकाल, रीतिकाल और आधुनिक काल में प्रकृति के बेहतरीन संदर्भ पाए जाते हैं। हिंदी के महान समीक्षक, लेखक, कवि हजारीप्रसाद द्विवेदी जी ने अपनी रचनाओं में कहा है पेड़-पौधे औषधीय गुणों से युक्त है- ‘यह धरती मेरी माता है और मैं इसका पुत्र हूँ इसलिए मैं सदा ही इसका सम्मान करता हूँ और मेरी धरती माता के प्रति नतमस्तक हूँ।’<sup>2</sup>

हिंदी के आधुनिक काल छायावादी काव्य में पर्यावरण के सबसे अधिक संदर्भ पाए जाते हैं। छायावादी काव्य को कई आलोचकों ने ‘प्रकृति काव्य’ नाम से पहचाना है। इस काल के जयशंकर प्रसाद, सुमित्रानंदन पंत महादेवी वर्मा, सूर्यकांत त्रिपाठी ‘निराला’, मैथिलीशरण गुप्त, हरिवंशराय बच्चन आदि ने अपने-अपने काव्य में ‘प्रकृति’ एवं ‘पर्यावरण’ सौंदर्य का चित्रण बहुत ही बड़ी

सुंदरता के साथ किया है। इसे आधुनिक काल के गद्य काल का एक परिवर्तित रूप भी कहा जाता है। हिंदी साहित्य के काव्य में विशेष रूप से आधुनिक काल की काव्यधारा में एक नवीन धारा पैदा हुई जिसे 'छायावाद' नाम से जाना गया है। काव्य में 'प्रकृति' एवं 'पर्यावरण' को सुंदरता के साथ प्रस्तुत कर प्रसाद जी जैसे कवि ने 'पर्यावरण' एवं 'प्रकृति' के प्रति चिंतन किया है। अपने महाकाव्य 'कामायनी', 'झरना', 'आंसू', 'चंद्रगुप्त', 'एक घूंट आदि में चिंतन पाया है।

हिंदी के प्रसिद्ध कवि सच्चिदानंद हीरानंद वात्सायन 'अज्ञेय' जी ने अपनी कविता में पर्यावरण का संबंध मानवीय भावनाओं से जोड़ दिया है। मनुष्य का जीवन जनवादी समझते हैं- आंगन के पार द्वार में वह यही क्षणवादी दृष्टिकोण को दर्शाते हैं- "झील का निर्धन किनारा और..., सन्नाटे ... हमारा... सूर्यास्त फिर नहीं दिखा"।<sup>3</sup> अज्ञेय जी प्रकृति के माध्यम से प्रेम की अभिव्यक्ति प्रस्तुत करते हैं। उन्होंने अपनी कविताओं में कोयल पपीहे के अलावा हरियल, चिड़िया, काक जैसे नग्न पक्षियों को भी स्थान दिया है। उन्होंने 'पूर्वा' में घास जैसे नग्न वस्तु को भी महत्व दिया। "कौन- सा वह अर्थ जिसकी अलंकृति कर रख नहीं सकती वह पैरों तले की घासा"।<sup>4</sup> यही 'अज्ञेय' जी अपनी 'हिरोशिमा' कविता में मनुष्य द्वारा फेंके गए विध्वंसकारी अणुबम के दुष्परिणाम को अंकित करते हैं। मनुष्य को ही नहीं सारी प्रकृति को, पर्यावरण की समस्या को, कवि अत्यंत चिंता स्वरूप स्थिति को दर्शाते हुए मनुष्य तथा प्रकृति की रक्षा हेतु अत्यंत विनाशकारी बम का प्रयोग न करने की सलाह देते हैं। अज्ञेय जैसे महान कवि ने मानव और पर्यावरण के अंतर संबंधों को प्रस्तुत किया है। उन्होंने अपनी कविता 'असाध्य वीणा' में मनुष्य को अहंम का त्याग करने का तथा आत्मानुभूति प्राप्त करने की प्रेरणा दी है। क्योंकि मानव को प्रकृति से तादात्म्य स्थापित कर मनुष्य की संपूर्ण स्थिति और जीवन प्रकृति पर निर्भर है। और वही मनुष्य प्रकृति के प्रति, पर्यावरण के प्रति आंख मिचोली का खेल-खेलता दिखता है। जो खतरे से खाली नहीं है। खतरे तो दिन-ब-दिन बढ़ते हुए नजर आ रहे।

#### वर्तमान काल की हिंदी कविता में पर्यावरण के संदर्भ:-

वर्तमान काल में चारों ओर फैले प्रदूषण को हम कम करने के हेतु बहुत ही अधिक कोशिश कर रहे हैं। जैसे कि नदी का जल औद्योगिक कल कारखानों द्वारा छोड़े हुए दूषित पानीओं के कारण प्रदूषित हो रहा है। धरती की मिट्टी भी अनउपजाऊ कक्षा रही है। यहां तक की अल्कोहलिक बरसात हो रही है। जगह-जगह पेड़ पौधे काटे जा रहे हैं। यहां तक की पहाड़, पर्वत आदि से मिलती खनिज संपदा को उद्योग, व्यापार वर्ग के लोग उन्नति के नाम पर लूट रहे हैं, उसका दोहन कर रहे हैं। शारदा बैनर्जी अपनी कविता 'ओ ताजी हवा में', लिखती है- "ओ ताजी हवा तरंगायित करो हृदय मेरा, कि वह बंधन मुक्त हो हिलोरे ले उछले, फिर मिल जाए समुद्र से"।<sup>5</sup> वास्तविक रूप में देखा जाए तो इस प्रकृति ने मनुष्य जीवन को जीवित रहने के लिए हर एक सुविधा तथा अनेक उपयुक्त साधन प्रदान किए हैं। लेकिन मनुष्य उसका अति दोहन कर रहा है। अब हमें इस पूर्ण रूप से प्रकृति पर्यावरण को स्वस्थ बनाने हेतु ठोस आरंभ कर देना चाहिए। वास्तविक रूप में आरंभ तो कर दिया है लेकिन उसे बीच में ही छोड़ दिया जाता है। कवी जितेंद्र जलज कहते हैं कि, "जब- जब जो जो चाहा, जो जो मांगा, धरती ने कभी हाथों को, संकुचित नहीं किया, फिर ऐसा क्यों? कि हम अब दे नहीं सकते धरती को, चिरायु के लिए, प्रदूषण मुक्त पर्यावरण"।<sup>6</sup>

आज जीव-जंतुओं के घर बार मनुष्य ने उजाड़ दिए हैं। हिंदी काव्य में कोयल के माध्यम से कविविश्व के समस्त जीव-जंतुओं के प्राकृतिक आवास के नष्ट होने की समस्या को अपनी कविता के माध्यम से उठाता है। आज जंगलों को नष्ट होते देख रहे हैं। जीव-जंतु विलुप्त हो गए हैं। जो आज कल बच्चे हैं उनके उज्ज्वल भविष्य के लिए कवि चिंता व्यक्त करता है। अतः दिपक कुमार जैसे कवि कहते हैं, "पास के गांव खेड़े से भटकी एक कोयल, कूक रही है भरी दुपहरीया में कंक्रीट की अमरिया में, कहां बची है छाव, जो इत्तीनान से तू ले सके आलाप, कोई तो अमराई बची होगी कहीं पर, शहर के बनने की यह रफ्तार है री, जिस तेजी से कटते हैं दरकत उससे तेज बनते हैं मकान कमबख्त, इन की नींवों में दफन है, ... ग्रामदेवता बचा नहीं पाए, अपने बरगद, पीपल, सरई खम्हार और, अमराइयों पर लदे बेर, मेरी तरह तू भी दूँड अब दू जा ठोरा"।<sup>7</sup>

प्रदूषित होती नदियां, उनकी साफ- सफाई तथा सरकारी योजनाओं का क्रियान्वयन पर होता भ्रष्टाचार पर कवि सच्चाई व्यक्त करता है। हिंदी के प्रसिद्ध कवि बुद्धिलाल पाल अपनी कविता 'नदियां' में लिखते हैं- "नदिया कल भी बहुत ही थी, बहुत ही है, आज भी नदियां कल भी नदियां थी आज भी पहचान है, व्यवस्था के नाम पर, उल्टी बहती नदियां... बताते हैं नदियां"।<sup>8</sup>

आज समूचा विश्व 'ग्लोबल वार्मिंग' जैसे शब्द से पीड़ित है। कार्बनिक पर्यावरण पर आज सरकार की ओर से तथा सेवाभावी संस्था द्वारा अलग-अलग प्रकार से जनजागरण के समारोह हो रहे हैं। कोशिश तो अच्छी है लेकिन नतीजे सौ प्रतिशत चाहिये वह नहीं आते। पेड़-पौधे लगाये जाते हैं लेकिन रक्षा के लिए उचित उपायोजना होती नहीं नजर आती। पर्यावरण पर कवी जागृत है। शंभुनाथ जैसे कवी ने 'पेड़ की पुकार' कविता के द्वारा पेड़ की महत्ता अधोरेखित की है- "रो रोकर पुकार रहा हूँ, हमें जमीन से मत ऊखाडो। रक्तसाव से भीग गया हूँ मैं कुल्हाड़ी अब मत मारो... कितने फूल, फूल हम देते फिर भी अनजान बने हो, हमी से सुंदर जीवन मिलता बुरी नजर मुझसे मत डालो... पेड़ लगाओ, हर प्राणी में जगा दो रो- रोकर पुकार रहा हूँ, हमें जमीं से मत उखाडो"।<sup>9</sup>

आज काबेन, गैस के उत्सर्जन से मनुष्य का जीवन असुरक्षित बन गया है। धरती का ताप साल-दर-साल बढ़ता जा रहा है। इस पर हिंदी के प्रसिद्ध कवि अरुण कमल जी कहते हैं कि, “आ रहा है ग्रीष्म, देहका एक-एक रोम अब, खुल रहा है साफ और अलग, नभ इतना खुला और फैलता हुआ, सूरज के डूबने के बाद भी...”<sup>10</sup>

### समकालीन हिंदी कविता में पर्यावरण के संदर्भ:-

समकालीन कवि सूर्यकांत त्रिपाठी निराला एक ओर प्रकृति पर्यावरण का संबंध रहस्यवाद से जोड़ देते हैं। “तुम तुंग हिमालय श्रृंग और मैं चंचल गति सुर सरिता तुम विमल हृदय, उच्छ्वास और मैं कांत कामिनी कविता” यही कवि ‘निराला’ जी अपनी कविता में ‘कुकुरमुत्ता’ को लेकर प्रगतिशील चेतना का व्यंग्य रूप में वर्णन करते हैं-“अबे सुन बे गुलाब, भूल मत जा पाई खुशबू रंगो खून चूसा खाद का तूने अशिष्ट डाल पर इतरा रहा है कैपिटल लिस्ट”<sup>11</sup>

इस काल की कवयत्रीयों में स्नेहमयी चौधरी का नाम एक संवेदनशील पर्यावरण वादी कवयत्री के रूप में लिया जाता है। उनकी अधिकतर कविताओं में पर्यावरण असंतुलन बढ़ता हुआ प्रदूषण संबंधी चिंता व्यक्त हुई है। स्नेहमयी चौधरी के ‘चौतरफा लड़ाई’ नामक कविता संग्रह में 1982-1985 तक लिखी गई कविता संग्रह में प्रकाशित है। इसमें अधिकतर कविताएं पर्यावरण असंतुलन विषय को लेकर लिखी हुई हैं। कवयत्री ‘तालाब’ नामक कविता में लोगों को जल प्रदूषण तथा वायु प्रदूषण के प्रति सजग करती है-“एक झील थी जिस पर कोई जमी थी, कीचड़ भी था, पारदर्शी पानी लुप्त हो गया था, सूरज का प्रकाश बुझ गया था” अपनी कवयत्री, ‘नजर’ नामक कविता में वायु तथा जल प्रदूषण के बारे में लिखती है-“अतः हम आकाश की ओर नहीं देख सकते, पानी जहरीला हो गया है, पी नहीं सकते हवा विषाक्त है, सांस कहां है”, सचमुच पानी सजीवों का जीवन है। पानी के लिए सभी मानव आकाश की ओर देखते रहते थे क्योंकि आकाश से गिरने वाला पानी शुद्ध स्वच्छ होता था परंतु आज उनमें जहरीले वायु हवा से, पानी में मिल जाने के कारण पानी भी जहरीला बन गया है। वह मानव के लिए उपयुक्त होकर वह अपाय कारक बन गया है। इसलिए मानव आज आकाश की ओर देख नहीं है सकता, अनेक जहरीले वायु के कारण हवा अशुद्ध बन गई है। उसमें मानव सांस तक नहीं ले सकता। ऐसी विषाक्त हवा में सांस कहां से ले सकेगा। इसके लिए कवयत्री मानव को उसके बीमारियों का कारण ‘पर्यावरण’ है और वह मानव के कारण ही ‘पर्यावरण’ बिगड़ा हुआ है यह स्पष्ट कर देती है। अपनी ‘चिड़िया’ नामक कविता में कवयत्री ‘ध्वनि प्रदूषण के बारे में मानव को चिड़िया के माध्यम से सचेत करती है-“चू चू कर रही है बसों, मोटरों, ट्रक और मोटरसाइकिल, फिल्मी गीतों और तेज पॉप म्यूजिक के शोर के खिलाफ जेहाद बोल रहा है जैसे” आज विभिन्न देशों के भीतर एक विषय स्पर्धा चल रही है। अणुअस्त्रों के प्रयोग से हवा में विषैली गैस फैल जाती है। वही विषैली हवा सजीवों के शरीर में घुल मिल जाती है। तब अनेक लोग अपाहिज हो जाते हैं। अंधे हो जाते हैं। फेफड़े खराब हो जाते हैं। मस्तिष्क की शिराएं अशक्त हो जाती हैं। इस प्रकार की अनेक समस्याओं से मानव को मुकाबला करना पड़ता है। कवयत्री अणुअस्त्रों का प्रयोग करने के बारे में अपनी कविता ‘मुहाबरे’ के माध्यम से लोगों के मन में सजगता निर्माण करते हुए कहती है-“आकाश को युद्ध भूमि में कल्पित करते हैं चांदनी पीली होने लगी... मुझे बचा लो, मुझे बचा लो, पेड़- पौधों की तरह, मुझे मत छोड़ो, गंगा-यमुना, गोदावरी आदि पवित्र नदियों के जल की तरह मुझे प्रदूषित मत करो...”<sup>12</sup>

हिंदी के प्रकृति प्रेमी कवि केदारनाथ सिंह जी अपनी कविता में ग्राम प्रकृति, पर्यावरण से प्रेम करते हैं। अपनी ‘दुपहरीया कविता में वह दोपहर के वातावरण से मन में उत्पन्न होने वाली उदासी का चित्र अंकित करते हैं। उनके ढेर सारी कविता संग्रह के शीर्षक भी प्रकृति, पर्यावरण से जुड़े हुए नजर आते हैं। फागुन का गीत बसंत गीत, पतझड़ की एक शाम, सूर्यास्त, मार्च की सुबह, बादल आओ, जब वर्षा शुरू हुई चांदनी, पपीहा, दिन आदि कविताएं प्रकृति पर्यावरण सौंदर्य से संबंधित हैं। इनकी कविताओं में एक और सौंदर्य बोध तो दूसरी ओर प्रकृति से जुड़ने का भाग है। वे दोस्तों की स्थिति बदलना चाहते हैं इसलिए पर्यावरणका सहारा लेते हैं ‘बारिश’ यहां पीड़ितों की यात्रा का प्रतीक है और ‘गधा’ चुपचाप अन्याय सहन करने वाली आशा है। बेचारी जनता का प्रतीक है। वह समाज में क्रांतिकारी परिवर्तन लाना चाहते हैं। इसलिए वह अपनी कविता ‘कीड़े की मृत्यु’ में लिखते हैं, ‘गधा इतना भीग चुका था कि अब वह उसे पूरे दृश्य के नायक की तरह लग रहा था’<sup>13</sup>

### हिंदी गद्य साहित्य में पर्यावरण के संदर्भ:-

प्राचीन काल से लेकर आधुनिक काल तक हर कवि ने अपने आप को प्रकृति से जोड़ दिया है। हिंदी का शायद ही कोई कवि ऐसा बिरला होगा जिन्होंने प्रकृति पर्यावरण को लेकर कविता लिखी नहीं होगी। आधुनिक हिंदी साहित्य में कमलेश्वर एक ऐसे उपन्यासकार हैं जिन्होंने पर्यावरण की समस्या को लेकर ‘अनबीता व्यतीत’, नामक बहुचर्चित उपन्यास लिखा। 2004 में प्रकाशित इस उपन्यास ने पूरे हिंदी साहित्य को और पर्यावरण प्रेमियों को सजग कर अंतरमुख कर दिया। आधुनिक युग में मनुष्य अपने सुख-सुविधा के लिए प्रकृति का इस तरह दोहन शुरू किया है कि जीव-जंतुओं का अस्तित्व ही खतरे में पड़ गया है। यह उपन्यास पर्यावरण की समस्या को पाठकों के सामने रखने का काम करता है। दशकों बाद मनुष्य ने पर्यावरण के महत्व को पहचाना और

वन्यजीवों के संरक्षण पर ध्यान देना शुरू किया किंतु व्यवसाय एवं स्वार्थी ममसिकता वाले व्यक्ति अपने लाभ के लिए पशु पक्षियों की हत्या का कारोबार कर जी रहा है। प्रस्तुत उपन्यास में अत्यंत मासूम वन्यजीव पशु पक्षियों की पीड़ा तथा उनके जीवन को संकट में करने वाले एवं उनके शरीर को ही अपनी जीविका का साधन बनाने वाले व्यक्तियों की कथा को उद्घाटित करने का प्रयत्न किया गया है। यह उपन्यास पक्षियों की दारुण मृत्यु परंपरा के अंधे अभियान से मुक्ति का एक आख्यान है। उपन्यास का स्रक गौतम अपनी मां की इच्छा पूरी करने के लिए उज्जैन में धर्मशाला बांधने के बजाय सुमेरगढ़ में नगरपालिका की ओर सीली झील खरीद करता है और वहां प्राणी मात्र की धर्मशाला बना देता है। झील की सरहद पर बोर्ड लगा देता है “पंछियों का धर्मशाला, यहां शिकार करना मना है।”<sup>14</sup>

जयशंकर प्रसाद जी का 'स्कंदगुप्त' एक ऐतिहासिक और महान नाटक है जो विशेष लोकप्रिय रहा है। इसी नाटक में 'भारत महिमा' नामक एक नाट्यगीत है। इस नाट्य गीत के द्वारा प्रसाद जी ने भारतवर्ष की अपार सुंदरतम पर्यावरण की स्थिति को दर्शाया है। भारत एक ऐसा संसार का देश है जो प्रकृति में हिमालय, रेगिस्तान, पहाड़, पर्वत, खाई, खंदक, नदी, नाले और ऋतुओं से परिपूर्ण देश है। कवि का कहना है-“ भारत हिमालय के आंगन में बसा हुआ है और सूरज अपनी प्रथम किरणों का उपहार हिमालय के आंगन में ही देता है अर्थात् हिमालय की शुद्धता स्वच्छ ही बर्फ पर उषा कालीन आलोक के फैलने से भारत माता के गले में हीरों का हार पहनाया गया है ऐसा आभास हो रहा था। सूर्योदय, पर्यावरण प्रकृति के प्रयोग से भारतवासी जागृत होते हैं सारे विश्व में ज्ञान का प्रकाश फैलाने का काम, आकाश में फैला अंधकार का साम्राज्य नष्ट हो और विश्व अज्ञान के कारण मन में छाई दुख से मुक्त हो यही मंगल कामना कवि करता है-“हिमालय के आंगन में उसे प्रथम किरणों का दे उपहार...” अथवा “अरुण यह मधुमय देश हमारा, जहां पहुंच अनजान क्षितिज को मिलता एक सहारा”<sup>15</sup>

#### निष्कर्षतः

कहा जा सकता है कि, हिंदी साहित्य में पर्यावरण विषय को लेकर हर कवि, साहित्यकार, रचनाकार ने अपने अपने विचारों को, भावनाओं को वाणी देने का प्रयास किया है। चाहे कविता हो, कहानी हो, उपन्यास हो, या नाटक हो। हर कवि का लक्ष्य यही रहा है कि प्रकृति ही मनुष्य जीवन का अविभाज्य अंग है। पंचतत्व में से एक भी हिस्सा ना हो तो मनुष्य का जीवनक्षणभंगुर अर्थात् समाप्त हो जाएगा। उसे बचाए रखने के लिए हर कवि ने आम भारतवासियों को सजग, सचेत करने का प्रयास किया है। इतना ही नहीं प्रकृति का संबंध मानव जीवन के साथ जोड़कर प्रतीकात्मक स्वरूप सूर्योदय, सूर्यास्त, पहाड़, पर्वत, नदी, नाले, खाई, खंदक, समंदर, जल, आकाश आदि प्राकृतिक संदर्भ, उनका मानवीय जीवन के उथल-पुथल से सुख-दुख के साथ हर्ष-उल्लास से जोड़ दिया है। इतना ही नहीं हर त्योहार, त्योहारों पर निर्भर गीत, प्रकृति से जुड़े हैं। हिंदी हो या किसी भी भाषा में बने हर सिनेमा के गीत भी प्रकृति से जुड़े हैं। पर्यावरण का, प्रकृति का एक महत्वपूर्ण ऋतु-सावन है। इसी सावन, बादल, बरसात को लेकर करीब 300 से अधिक गीत लिखे गए हैं। पर्यावरण की खुशहाली ही मनुष्य ही खुशहाली है। पर्यावरण का विनाश मनुष्य जीवन का विनाश, -हास, बर्बादी है। इसीलिए हे मनुष्य सचेत रहें। सावधान रहें। अपने उज्वल भविष्य के लिए 'पर्यावरण' को बचाए, बनाए रखने का संदेश हिंदी के साहित्यकारों ने दिया है।

#### संदर्भ:-

1. रामचरितमानस किष्किंधाकांड, श्लोक-11, चौपाई-2, तुलसीदास, गीता प्रेस गोरखपुर।
2. हजारी प्रसाद द्विवेदी ग्रंथावली, हजारी प्रसाद द्विवेदी, 'कुटज', अंक-9, पृष्ठ-32, राजकमल प्रकाशन प्राइवेट लिमिटेड, नई दिल्ली।
3. आंगन के पार द्वार, सच्चिदानंद हीरानंद वात्सायन, 'अज्ञेय'।
4. 'पूर्वा', सच्चिदानंद हीरानंद वात्सायन, 'अज्ञेय'।
5. ओ ताजी हवा, शारदा बैनर्जी, 'वागर्थ', अक्टूबर -2016, पृष्ठ-37
6. ऐसा क्यों ?, जीतेन्द्र जलज, 'वागर्थ', अक्टूबर 2016, पृष्ठ-82
7. कंक्रीट अमरैया में कोयल की कूक, दीपक कुमार पाचपोर, 'वागर्थ', मार्च 2016, पृष्ठ- 70
8. नदियां, बुद्धिलाल पाल, 'वागर्थ', अगस्त 2016, पृष्ठ- 71
9. 'पेड की पुकार', शंभुनाथ सरस्वती प्रेस, इलाहाबाद।
10. पुतली में संसार अरुण कमल (internet www.kavitakosh.org)
11. आधुनिक कविताएं, संपा.डा. प्रसाद-डा. जोशी, लोकभारती प्रकाशन, इलाहाबाद, 1991
12. चौतरफा लड़ाई, स्नेहमई चौधरी, 1982-1985.
13. 'जमीन पक रही है', केदारनाथ सिंह, प्रकाशन संस्था, दिल्ली, 1980.
14. कमलेश्वर, अनबीता व्यतीत(उपन्यास), लोकभारती प्रकाशन, नई दिल्ली।

## उमरगा व लोहारा तालुक्यातील पाणलोट क्षेत्र विकास एक भौगोलीक अभ्यास

डॉ. सुर्यकांत लालचंद राठोड

भूगोल विभाग प्रमुख

बी.एस.एस.कला विज्ञान व वाणिज्य महाविद्यालय

माकणी ता. लोहारा.जि.उस्मानाबाद

### १)प्रस्तावना :-

पूर्वापार चालत आलेली म्हण " थेंबे थेंबे तळसाचे" ही जरी पाण्यावरून निर्माण झाली असली तरी हल्ली आपण तिच्याकडे कानाडोळा केल्यासारखे दिसत आहे. पावसाच्या प्रत्येक थेंबाची आपणास गरज आहे असे आपण तावतावाने मांडतो;परंतु तो थेंब साठवून त्याचा गरजेच्या वेळी कसा उपयोग करता येईल,याबद्दल मात्र आपण आजपर्यंत उदासीन राहिलो आहोत.पण आज शेती हा व्यवसाय शेतकऱ्यांना परवडेनासे झालेला आहे. कारण पावसाचे दिवसेंदिवस कमी होत चाललेले प्रमाण वाढते तापमान,वाढती लोकसंख्या, त्या मुळे होणारे दुष्परीणाम, पाण्याचा वाढलेला बेसुमार उपसा आणि त्यामुळे भेडसावणारी भीषण पाणी टंचाईमुळे नजरेआढ दढलेल्या भूजलाने आता सगळ्याचे लक्ष वेधून घेतले आहे.महाराष्ट्रात प्रामुख्याने आढळणाऱ्या बेसाल्ट खडकाची पाणी साठवून ठेवण्याची क्षमता कमी असल्याने पाणी व्यवस्थापण किती महत्वाचा आहे हे सुद्धा आपल्या लक्षात आले आहेच.तरी पाणी व्यवस्थापन आज किती महत्वाचे आहे हे लक्षात आले आहे.

आपल्याला हे माहित आहे. की जमीन सहसा कधी सम पातळीत नसते. जमिनीमध्ये थोडाफार उंचसखलपना असतोच. डोंगर असतात., पर्वत असतात. घळी आसतात, नद्या असतात, सपाट मैदानी प्रदेश असतात. या मुळे जमिनीवर पडणारे पाणी त्याच ठिकाणी साचून न राहता उताराच्या दिशेने वाहू लागते. अशा तऱ्हेने पाणी ओढयाला मिळते. ज्या वरच्या भागातुन पाणी वाहत येते त्या भागाला त्या ओढयाचे पाणलोट क्षेत्र म्हणतात. महाराष्ट्र शासनाने या संकल्पनेला अनुरूप असा सर्वकष पाणलोट क्षेत्र विकास कार्यक्रम राबविण्याचा निर्णय घेतला आहे.या कार्यक्रमाचा मुळ उद्देश जमिनीची धूप थांबविणे, पाणी मूलस्थानी मुरविणे,भूगर्भातील पाणी साठा वाढविणे, भूगर्भातील पाणी साठा पीकासाठी वापरणे हा आहे.

२)संज्ञा: पाणलोट क्षेत्र म्हणजे पाणलोट क्षेत्र हे एक असे विशिष्ट क्षेत्र आहे. की ज्याच्या तिन्ही बाजुस चढ असून पावसाचे पाणी लहाण मोठया ओघळीतुन मुख्यनाल्यास अथवा नदीस ज्या एके ठिकाणी येवून मिळतात तसा ठिकाणापासून तर चढापर्यंत असलेल्या संपूर्ण क्षेत्रास पाणलोट आसे म्हणतात.

गाव हा विकासाचा मुख्यपाया धरुण पाणलोटार आधारीत मृद संधारण व जलसंधारणाची कामे करणे अभिप्रेत आहे. या सर्वांमध्ये एक महत्वाची बाब विचारात घेतली आहे. ती म्हणजे पाणलोट क्षेत्र विकासासाठी निवडले की ,त्या पाणलोट क्षेत्रावर जो पाऊस पडतो त्या पावसाच्या पाण्याचे नियोजन करता येते.पावसाचे पडणारे पाणी त्यातुन किती पाणी उपलब्ध होणार आहे.त्यातील किती पाणी विविध जलसंधारणाचे माध्यमातुन अडविता येईल आणि किती पाणी शिल्लक राहिल, या सर्व बाबीचा विचारात घेण्यात येतात. पाणलोट क्षेत्रामध्ये जमिनीचा उतार, जमिनीचा प्रकार, जमिनीचा वापर व पाणी साठविण्यासाठी भूगर्भातील क्षमता इत्यादी बाबीचा विचार करुन कामाचे नियोजन करता येते.

### ३)विषयाची निवड :-

या विषयाची निवड करण्याचा मुख्य उद्देश म्हणजे आज भूपृष्ठावर पडणारे पाणी नाले,ओढे,नदी च्या स्वरुपाने सर्व पाणी वाहून समुद्राला मिळते .या पाण्याचा उपयोग शेती किंवा पीण्यासाठी होत नाही .या पाण्याचा उपयोग शेती किंवा पीण्यासाठी व्हावा यासाठी पडणारे पाणी थेंबन थेंब जमिनीत मुरले पाहिजे.जमिनीत पाण्याची पातळी वाढवण्यासाठी पाणलोट क्षेत्र आवश्यक आहे.मृदा संधारणची कामे आवश्यक आहे. म्हणून या विषयाची निवड करण्यात आली आहे.

### ४)उद्दिष्ट्ये :- भूगर्भातील पाण्याची पातळीत वाढ करणे.

- १ गावातील शेतीसाठी संरक्षित सिंचनाची सोय करणे.
- २ जमिनीची प्रचंडप्रमाणत होणारी धूप थांबवणे.
- ३ पडीक जमिनीचा विकास करणे.
- ४ पाणलोट विकासाची कामे करुण शेती उत्पादनात वाढ करणे.

### ५)विषय विवेचन :-

महाराष्ट्रात मोठया प्रमाणात शेती हा व्यवसाय केला जातो.पण शेती ही जुगार पध्दतीची आहे असे मानले तरी चालेल. कारण ही शेती पावसावर अवलंबून आसल्याने पाऊस कधी जास्त तर कधी कमी हातो. कधी उषीरा तर कधी कधी पडतच नाही. यामुळे शेती हा व्यवसाय आज धेक्यात आला आहे. पीकलेल्या धाण्यास योग्य भाव ही मिळत नसल्याने आज शेतकरी कर्जबाजारी होवून आत्महात्या करत आसल्याचे दिसून येते. महाराष्ट्रातील शेती ही प्रामुख्याने कोरडवाहू आहे. उथळ जमिनीचे आसल्याने पाण्याचे किंवा सिंचनाची सोय नसल्याने उत्पादनाचे प्रमाण कमी आहे. वाढती लोकसंख्या याचा विचार करुण अन्न धान्याचे प्रमाण कमी होत आहे.अन्नधान्याचे प्रमाण वाढविण्यासाठी जलसिंचनाची आवश्यकता आहे. म्हणून आज पाणलाट क्षेत्र विभागात जलसंधारण कामे करुण पाणी पातळी वाढविणे ही काळाची गरज आहे. म्हणून महाराष्ट्रात पाणलोट क्षेत्र विकासाची वेगवेगळी कामे केली जातात.कोरडवाहू शेतीमध्ये जमिनीवर पडणाऱ्या पावसाचा प्रत्येक थेंब जेथे पडतो, तिथेच ते मुरविल्यास जमिनीमध्ये

ओलावा दीर्घकाळ टिकून ठेवण्यास मदत होते.नाले- ओहोळावर घडीचा बंधारा सुयोग्य निवडून बांधावा. या बंधाऱ्यासाठी गावातच उपलब्ध असलेले साहित्य योग्य पध्दतीने आखणी करून वापरता येते.

### १)पाणलोट क्षेत्र :-

ज्या क्षेत्राचे पाणी नैसर्गिकरित्या वाहत येवून एका नाल्याद्वारे एका ठिकाणहून वाहते त्या संपुर्ण क्षेत्रास पाणलोट क्षेत्र आसे म्हणतात.एखादया प्रवाहास प्रमाणबध्द मानून त्यामध्ये ज्या क्षेत्रामधून पाणी वाहत येवून मिळते त्या प्रवाहाचे पाणलोट क्षेत्र असे म्हणतात.

जमिनीवर पाऊस पडतो. पाणी वाहू लागते.ते वाहणारे पाणी आपल्यावरोबर जमिनीचा वरचा जो अतिशय सुपीक थर असतो तो घेऊन जाते.म्हणजे आपण प्रतिबंध न केल्यामुळे जमिनीचा सुपीकपणा कमी झाला; उत्पादन कमी झाले.हे जर आपण टाळले, काही कामे करून मातीची धूप थांबवली, तर पुढील सर्व अनिष्ट गोष्टी टळून उत्पादनात भर पडेल.

### पाणलोट क्षेत्राचे क्षेत्रानुसार वर्गीकरण

१	अतिलहान पाणलाकट क्षेत्र (Micro Watershed)	१० हेक्टर पर्यंत
२	लघु पाणलोट क्षेत्र (Mini Watershed)	२०० हेक्टर पर्यंत
३	उप पाणलोट क्षेत्र (Sub Watershed)	४००० हेक्टर पर्यंत
४	नदी खोरे (River Vally)	क्षेत्र मर्यादा नाही

पाणलोट क्षेत्राच्या आकाराचा परिणाम त्याच्या निर्गम मार्गापाशी येणाऱ्या पाणलोट्याच्या परिणामावर होतो. पाणलोट क्षेत्रातुन येणाऱ्या पाणलोट्याचे प्रमाण हे त्याच्या लांबी व रूदीच्या गुणोत्तराशी संबंधीत असते. ते लांबीशी व्यस्त प्रमाणात तर रुंदीशी सम प्रमाणात असते. पाणलोट क्षेत्राची लांबी त्यांच्या रूदीपेक्षा जास्त आसेल तर निर्गम मार्गाजवळ पाणी येण्यास जास्त वेळ लागतो. त्यामुळे पाणी खोळबुन राहण्यास व जमिनीत मुरण्यास वाव मिळतो.व निर्गम मार्गाशी कमी प्रमाणात पाणी येते. हीच परिस्थिती जर उलट असेले म्हणजे रुंदी लांबी पेक्षा जास्त आसेल तर संपुर्ण पाणलोट निर्गम मार्गापाशी लवकर येतो. त्यामुळे ते कमी प्रमाणात अडविले जाते. व जमिनीत कमी मुरविले जाते. तसेच निर्गम मार्गापाशी येणारा पाणलोट मोठा आसतो. तेव्हा पाणलोट क्षेत्राचे वेगवेगळे आकार कसे असू शकतात हे पाहणे आवश्यक आहे. साधरणपणे पाणलोट क्षेत्राचे आकार खालील प्रमाणे चार प्रकारे असल्याचे आढळून येईल व त्यावरून त्यातील पाणलोट्याच्या दिशेची कल्पना येवू शकते.

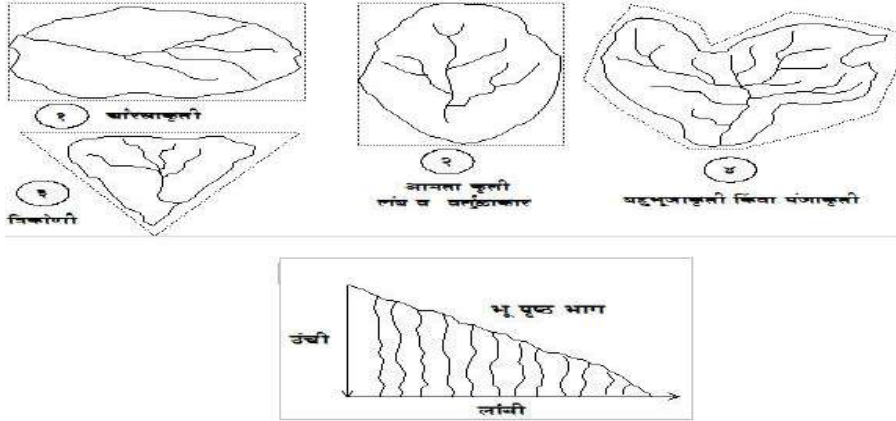

### २)पाणलोट क्षेत्र व्यवस्थापन:- Waterlog area Management

पाणलोट क्षेत्र व्यवस्थापन म्हणजे त्या क्षेत्रातील उपलब्ध जमिनी ,पाणी,वनस्पती, व इतर नैसर्गिक साधनसंपत्तीचा योग्यरितीने वापर करणे जेनेकरून जमिनीची धूप होणार नाही,पाणी आडवा पाणी जीरवा ही संकल्पना वापरात आणणे, भूगर्भात पाणी पातळी वाढविणे,कृषी उत्पादनात वाढ करणे ,जैविक समतोल राखणे,रोजगार हामी योजने आतर्गत रोजगाराच्या संधी उपलब्ध करणे आशा आनेक कामे जलसंधारणा मार्फत करण्यात येते.आशा आनेक विविध कामाचे नियोजन करून त्याचे व्यवस्थापण करणे आज आवश्यक आहे.

### ३)पाणलोट क्षेत्रामध्ये जमिनीची होणारी धूप:- Landing incense in the catchment area

पणी व वारा व तापमानामुळे जमिनीची धूप घडून येते. जमिनीच्या पृष्ठभागावरून वाहणाऱ्या अपधावेमुळे जमिनीची धूप होते. या धूपेच्या सालकाठी धूप, ओघळपाडी धूप व घळपाडी धूप या तीन आवस्था आहेत. घळपाडी धूप ही जमिनीच्या धूपेची शेवटची आणि विध्वंसक अवस्थेत जमीन लागवडी खाली आणता येत नाही. जमिनीच्या धूपेमुळे वाहुन गेलेली माती पुढे मोठमोठया जलाशयात साठवली जाते. त्यामुळे जलाशयांची पाणी साठवणक्षमता दिवसेंदिवस घटते.

जमिनीच्या धुपेवर पाऊस ,वारा, तापमान, वनस्पती आणि जमिनीचा प्रकार या घटकांचा परिणाम होतो. पडणाऱ्या पावसाचे प्रमाण आणि तीव्रता जास्त असेल तर जमिनीच्या होणाऱ्या धुपेचे प्रमाण जास्त आसते.जमिनीचा उतार जास्त असल्यास वाहणाऱ्या पाण्याचा वेग जास्त असतो. त्यामुळे मोठया प्रमाणावर जमिनीची धूप घडून येते.

**४)जमिनीची धूप थाबवणे To Dry The Soil**

जमिनीवर वनस्पतीचे, गवताचे आच्छादन केले पाहिजे. त्यामुळे होणाऱ्या धूपेचे प्रमाण कमी होईल. जमिनीवरील वनस्पतीच्या आच्छादनामुळे जमिनीची धूपोत्पादकता शक्ती कमी होते. मुळामुळे मातीचे कण एकमेकास घट्ट चिकटून राहतात. त्यामुळे जमिनीची धूप प्रकृतिशक्ती वाढते. शेती उत्पादकता वाढावी म्हणून जमिनीची धूप थांबविण्याबरोबरच शेतातून वाहून जाणारे अतिरिक्त पाणी अडविण्यावर भर देण्यात येत आहे. सन १९८२ पासून मृद आणि जलसंधारणाची विविध कामे पाणलोट क्षेत्र हा कार्यक्रम हाती घेण्यात आला . या कार्यक्रमांतर्गत मृदा व जलसंधारणाची कामे, कुरण विकास, वृक्ष लागवड आदी कामे हाती घेण्यात येत आहेत. पाणलोट क्षेत्र विकास कार्यक्रम राबविण्यामागे पाणलोट क्षेत्राचा सर्वांगीन विकास करणे त्या क्षेत्रात वाहणाऱ्या मानवी समुहाचा सामाजिक आर्थिक, स्तर उंचावने नैसर्गिक साधनसामुग्रीचे जतन करणे. गावपातळीवर रोजगाराच्या संधी उपलब्ध करून देणे या बाबी अंतर्भूत आहेत. पुर्वीच्या काळी मृदसंधारण एखादा शेतकरी अवलंबीत असत. परंतु पाणलोट क्षेत्रनिहाय विविध मृद व जलसंधारण उपाय घेतल्यास त्याचे चांगले परिणाम दिसतात. हे राज्यात राबविण्यात आलेल्या पाणलोट क्षेत्र विकासाच्या कामांनी दाखवून दिले आहे. त्यासोबतच राज्यातील ज्या भागात पाणलोट क्षेत्राची कामे पूर्ण झाली आहेत.

**६)उपाय योजना :-Measure Plan**

जमिनीची धूपेला प्रतिबंध घालण्यासाठी कृषी शास्त्रीय उपचाराबरोबर अभियांत्रिकी उपायही उपयोगाचे आहेत. कृषी शास्त्रीय उपचारांत समपातळी मशागत ,समपातही पेरणी, पिकाची फेरपालट, पट्टा पध्दत जमिनीवर आच्छादनाचा वापर, जैविक बांध बंदिस्ती, या उपचाराचा समावेश होतो.

अभियांत्रिकी उपचारांत समपातळी बांध, ढाळीचे बांध, घळी नियंत्रण उपचार, गॅबियन बंधारे, सलग समतल चर, एकाआड एक चरमजगीकरण, सपाट ओटे आदिचा अवलंब करून जमिनीच्या धूपेस अटकाव निर्माण करता येतो.तसेच वृक्ष लागवड, वनशेती, कुरण विकास, खस गवताची लागवड याद्वारे ही जमिनीची धूप रोखता येते. पाणलोट क्षेत्रावर आधारीत केलेल्या मृद व जलसंधारणाच्या कामानीच जमिनीच्या धूपेची समस्या आणि त्यातून पुढे उध्दभवणाऱ्या प्रश्नाची सोडवणूक होऊ शकते. अत्यंत हालक्या अशा जमिनीची मोठयाप्रमाणत धूप होते. अशा जमिनीवर त्या भागात येणाऱ्या गवताची बी फेकणे. वृक्ष लागवड व कुरण विकास करणे आश्यक आहे. ओघळीचे नियंत्रण करण्यासाठी लाईव चेक डॅम, ब्रशवूड डॅम, लुज बोल्टर स्ट्रक्चरर्स, गॅबियन बांधकामे, मातीचे व सिमेंटचे नालाबांध, डायव्हर्सन बंधारे, भूमिगत बंधारे आणि जेथे कठीण खडकामुळे भूगभात पाणी साठा होऊ शकत नाही त्या ठिकाणी हायड्रो फ्रॅक्चरिंग करणे आवश्यक आहे.

**७)संदर्भग्रंथ :- Bibliography**

- १) पाणलोट क्षेत्र विकास. चिंतामणी थिटे, प्रसाद रसाळ.
- २)पेटलेले पाणी. प्रा डॉ अनिलराज जगदाळे.
- ३) पाणी तुमचे आमचे. मुंकूंद धाराशिवकर
- ४) दैनिक पेपर
- ५) मासिक



## कृषी प्रदुषणाचा ग्रामीण जिजनावरील प्रभाव

प्राचार्य डॉ. प्रकाश पाटील

जयवंत महाविद्यालय, इचलकरंजी

भारत हा कृषीप्रधान देश आहे असे सर्वसाधारण विधान सातत्याने केले जाते. पण बारकाईने विचार केला तर ग्रामीण भागातील समाज व्यवस्था आणि तेथील लोकांचे राहणीमान, प्रथा, परंपरा आणि एकंदरीत जीवन पध्दतीच कृषी व्यवसाय केंद्रीभूत मानून त्या भोवताली फिरत असते. स्वातंत्र्य प्राप्तीनंतर पुढील जवळ – जवळ 17 –18 वर्षे आपला देश अन्नधान्य उत्पादनाच्या बाबतीत बराचसा परावलंबी होता. 1966 नंतर हरीतकांतीचे युग अवतरले आणि ग्रामीण भागातील कृषी आधारीत समाज व्यवस्थेचे रूप एकदम पालटले. हरीतकांतीच्या युगापूर्वी भारताला अन्नधान्याच्या बाबतीत परावलंबी रहावे लागत होते. अमेरिकेशी पी. एल.– 480 हा करार करून अमेरिकेकडून आपल्याला अन्नधान्य आयात करावे लागत होते. अन्नधान्याचे रेशनिंग करावे लागत होते. करीत कांतीच्या माध्यामातून आपल्या देशात धान्य उत्पादन खूप वाढले. लोकसंख्या कमी असताना अन्नधान्याच्या बाबतीत परावलंबी असणारा भारत अन्नधान्याच्या बाबतीत स्वयंपूर्ण तर झालाच पण त्याशिवाय अन्नधान्याची निर्यात करणे देखील चालू झाली.

कृषीक्षेत्र तसेच कृषी पूरक क्षेत्रात फार मोठया प्रमाणावर संशोधन झाल्याने ग्रामीण भारताची अर्थिकदृष्ट्या सधनतेकडे वाटचाल सुरु झाली. हरीत कांतीनंतर आलेली करीतकांती, निळी कांती यांनी कृषी व इतर पूरक क्षेत्रात व्यापक प्रमाणमध्ये बदल घडून आल्यामुळे ग्रामीण भागातील श्रमव्यवस्था म्हणून असलेली बलुतेदारी अलुतेदारी व्यवस्था नष्ट होवू लागल्या. आधुनिक शेतीला अनुसरून ग्रामीण भागामध्ये कृषी उद्योग–धंदे सुरु झाले. शेतीमध्ये अधिका – अधिक आधुनिक यंत्रसामुग्री, आधुनिक खते, किटक नाशके वापर वाढला. कृषी विद्यापीठे, कृषी संशोधन संस्था, तसेच खाजगी क्षेत्रातील रासायनिक उद्योगांनीही नव – नवीन संशोधने करून कृषी क्षेत्राचे परंपरागत रूप पूर्णपणे पालटून टाकले.

कृषीक्षेत्रात झालेली प्रचंड प्रगती हळूहळू अधोगतीकडे कशी वाटचाल करू लागली हे शेतकरी वर्गाच्या तसेच इतर संबधीत घटकांच्या लवकर लक्षात आले नाही, किंवा लक्षात आले तरी तिकडे सुरुवातीला बरेच दुर्लक्ष होत गेले. त्याची परिणीती ग्रामीण भागातील शेतजमीन, पाणी, पशुधन इ. बाबी प्रदुषित होत गेल्या व त्यांचा विपरीत परीणाम ग्रामीण जिजनावर घडून येवू लागला. त्याचा आढावा पुढील प्रमाणे घेता येईल.

### रासायनिक खते :

1960–61 पासून भारतीय शेतीमध्ये रासायनिक खतांचा वापर सुरु झाला. याच काळात अधिक उत्पादन देणा–या कृषी पिकांच्या विकसीत जातींना या रासायनिक खतांची गरज होती. 1960 – 61 पासून रासायनिक खतांचा वापर प्रचंड वाढत गेला. त्यामुळे उत्पादन वाढत गेले. पण दुस–या बाजूला त्या बरोबरच मातीचा कस कमी होत गेला. रासायनिक खतामध्ये एन.पी.के. च्या मिश्र खतांचे प्रमाण देखील वाढत गेले. त्यामुळे त्याचा कृषी क्षेत्रावर फारच विपरीत परीणाम झाला. 1961 मध्ये भारतात प्रती हेक्टर केवळ 2 किलो रासायनिक खते वापरली जात होती. तर सध्या ते प्रमाण 100 किलोहून अधिक आहे. हे प्रमाण विकसीत देशांच्या प्रमाणात कमी असले तरी त्याबरोबर सेंद्रीय खतांची जी मात्रा वापरणे आवश्यक होते ती वापरली जात नाही. त्यामुळे जमिनीचे नुकसान होत आहे. त्यातही रासायनिक खतामध्ये युरीयाचा वापर हा एकूण रासायनिक खताच्या 80 टक्के इतका आहे. या अयोग्य प्रमाणामुळे शेतजमीन दिवसेंदिवस निकृष्ट बनत चालली आहे.

### रासायनिक किटक नाशकांचा प्रचंड वापर :

खरे तर पिकावरील किड नियंत्रणासाठी नैसर्गिक किड नियंत्रण पध्दती वापरणे अपेक्षित आहे तर त्यातून किड नियंत्रणात अपयश आले तरच अल्प प्रमाणात रासायनिक किटक नाशकांचा वापर करणे अपेक्षित आहे. परंतु नैसर्गिक किड नियंत्रण उपाय योजनेपेक्षा रासायनिक किटकनाशक वापर वाढल्यामुळे त्याचे दुष्परीणाम कृषी उत्पादनावर घडून आल्याचे दिसून येते. अर्सेनिक, फ्ल्युरिन, गंधक आणि पारा यांची अनेक संयुगे रासायनिक किटकनाशके म्हणून वापरली जातात. या रासायनिक किटकनाशकांचा अपायकारक किटकावर जसा परिणाम घडून येतो तसाच दुष्परीणाम उपकारक किटकांच्यावर होवू लागला आहे. त्यामुळे परागीकरण प्रक्रियेत उपयुक्त ठरणारे मधमाशासारखे किटक नष्ट झाल्याने त्याचा परीणाम बिजावर होत आहे. त्यामुळे उत्पादन घट होवू लागली आहे. तसेच उपद्रवी किटकांची प्रतिकार क्षमता दिवसेंदिवस वाढत गेल्याने आजच्या आधुनिक शेतीमध्ये नव–नवीन उपद्रवी किटकांच्या जातीचा उपद्रव वाढू लागला आहे. पुर्वी नियंत्रणात असलेल्या अनेक किडी अधिक ताकदवान झाल्याने दिसून येवू लागली आहे.

दूस-या देशातून लागवडीसाठी वनस्पती आयात केल्याने त्यांच्याबरोबर तेथील किडींचाही आपल्याकडे प्रादुर्भाव वाढतो.

रासायनिक किटक नाशकांच्या अशा वापरामुळे शेती उत्पादनाचा दर्जादिवसेंदिवस घसरत चालला आहे.

### अतिरिक्त पाणी वापर

उसासारख्या बागायती पिकासाठी पाण्याचा प्रचंड वापर केला हात आहे.उस शेतीमध्ये जलसंपतीचा सुयोग्य वापर केला जात नाही. पाणी पुरवठा मुबलक असलेल्या ठिकाणी पाण्याचा अतिरिक्त वापर केला जात आहे. उसाची लागवड करतानाच स-या अशा पध्दतीने तयार केल्या जातात की उसाच्या शेताच्या एका टोकाला पाणी सोडले की ते दुस-या टोकापर्यन्त आपोआप पोहचते. त्यामुळे बहुतांश वेळा शेतकरी वर्ग शेताला एकदा पाणी सोडले की आपल्या शेताबरोबरच शेजारची शेते पाण्याने भरून गेली तरी तिकडे दुर्लक्ष करतात. अशा अती जलसिंचनाने अनेक ठिकाणच्या सुपीक जमीनींचे क्षारपड जमीनीत रूपांतर होत आहे. भारतातील जवळ जवळ 70 ते 80 लक्ष हेक्टर जमीन अशा प्रकारामुळे नापीक बनली आहे.

परिस्थिती की कार्यक्षमतेत घट - वाढत्या रासायनिक खते व रासायनिक किटकनाशकामुळे जमीनीतील पिके व त्या परीसरातील प्राणी यांच्यातील पारस्परिक नाते नष्ट होवू लागले आहे. उदा. बेडूक, साप यांच्या माध्यमातून पिकांचे किटक व उंदीर यांच्यापासून होणारे नैसर्गिक रक्षण आता थांबले आहे.

### कृषीपूरक व्यवसायातील रासायनिकीकरणाचा वापर -

कृषीपूरक व्यवसाय पशुपालन,कुक्कुटपालन,मत्स्यपालन इ. साठी जी संप्रेरके वापरली जातात त्यापैकी काही संप्रेरकांचा विपरित परीणाम मानवी जिवनावरही होत आहे. असे विविध संशोधनांनी सिध्द झाले आहे. तसेच त्यांच्या रोगनिवारणासाठी वापरली जाणारी औषधे या पशुपक्षांना होणारे रोग यांचेही संशोधन होणे आवश्यक आहे. कृषी आधारीत उदयोगांचे प्रदुषण

प्रदुषणाच्या दृष्टीने कृषी आधारीत उदयोगापैकी साखर कारखान्यांचाच प्रभाव यात जास्त दिसून येतो. साखर कारखाने व त्यावर आधारीत इतर उपपदार्थ निर्मितीमुळे देखील ग्रामीणी भागात मोठया प्रमाणावर प्रदुषण वाढत आहे. पश्चिम व उत्तर महाराष्ट्रातून वाहणा-या जवळ जवळ सर्व नदयाना साखर उदयोगातील प्रदुशनाने गासले आहे.

सर्वकश विचार करता कृषी क्षेत्रातील या प्रदुशणाचे ग्रामीण समाज जिवनावर घडून आलेले परीणाम पुढीलप्रमाणे नोंद करता येतील.

1. पाण्याच्या अतिरिक्त वापराने जमीनी क्षारपड बनू लागल्या आहेत. त्यामुळे जमीन हे उत्पादनाचे मूलभूत साधनच बाधीत होत आहे.
2. रासायनिक खते, किटकनाशके,तृणनाशके यांचा वापर वाढला आहे. त्यामुळे तयार होणारे कृषी उत्पादन आहारास अयोग्य बनत आहे. त्याच्या सेवनाने दुर्धर आजारांचे प्रमाण वाढत चालले आहे. कोल्हापूर जिल्हयातील शिरोळ तालुका अशा प्रकारच्या अतिरिक्त वापराने कॅन्सरग्रस्त बनला आहे. हे सिध्द झाले आहे.
3. कृषी व कृषीपूरक व्यवसायातील रसायनांच्या वापरामुळे ते सेवन करणा-यांच्या आरोग्याला धोका निर्माण झाला आहे.
4. भूपृष्ठ व भूगर्भ या दोन्ही ठिकाणच्या पाण्याचा अतीवापर केल्यामुळे भूगर्भातील पाण्याची पातळी धरत चालली आहे.
5. साखर कारखान्यांच्या सारख्या उदयोगांच्यामुळे नदया प्रदुशीत होवून पिण्याच्या पाण्याची समस्या निर्माण झाली आहे.

या सर्व बाबींचा प्रभाव ग्रामीण भागावर पडला आहे. त्यामुळे उत्पादन वाढ होवूनही भारतातील कृषीक्षेत्रातील आनंदाचा निर्देशांक घटत चालला आहे. असे खेदाने नमुद करावे लागते.

### संदर्भ :

- 1 साधनसंपतीचे अर्थशास्त्र - भोसले, काटे, फडके प्रकाशन पुणे
- 2 आधुनिक भारतातील विज्ञान व तंत्रज्ञान -डॉ.प्रमोद जोगळेकर सागर पब्लीकेशन
- 3 Bhagirath Beharu & V.Ratna Reddy "Environment and Accountability" Journal of Envir- Protection. Vol.No.22, Nov.9, 2007

## पर्यावरण व सार्वजनिक आरोग्य यांचा अभ्यास करणे

प्रा. अजितकुमार भिमराव पाटील.

एम. ए., बी. एड., एम. एड., डी. एस. एम.

संशोधक विद्यार्थी :- जे. जे. टी. यु. राजस्थान ; दिल्ली रजि. नं. २७८१७०६६

### १. प्रस्तावना

पर्यावरणाचा अभ्यास केला असता. मानव आणि पर्यावरण यांचे नाते फार पुरातन काळापासून जवळचे आहे मुळात मानवाचा शोध निसर्गामध्ये झाला निसर्गामधूनच ते नवीन गोष्टी शिकू लागला आदि मानव ते आधुनिक मानव इथ पर्यंतचा मानवाचा प्रवास प्रगतशिल आहे, तो सद्ध्याच्या युगात वावरत असताना हवेत संचार करू लागला, यंत्रांशी खेळू लागला व तो आधुनिक युगामध्ये सामर्थशाली बनू लागला. हे सर्व करत असताना आपल्या स्वतःच्या आरोग्यकडे त्याचे दुर्लक्ष करू लागला याचे त्याला भानसुद्धा राहिले नाही. म्हणून पर्यावरण व सार्वजनिक आरोग्याचा अभ्यास करणे गरजेचे आहे. : पर्यावरणीय व नीतिशास्त्र यामध्ये खनिज प्राणी मारणे किंवा अतिसंवर्तित स्वदेशी प्रजातीचे काही वैयक्तिक सदस्य नष्ट करणे ही विशिष्ट पर्यावरणाच्या अखंडतेच्या संरक्षणासाठी आवश्यक आहे. ही क्रिया नैतिकदृष्ट्या परवानगीयोग्य किंवा आवश्यक असेल? गैर-औद्योगिक देशांतील शेतकऱ्यांसाठी नैसर्गिकरित्या स्वीकारार्ह आहे की शेतीसाठी क्षेत्र स्वच्छ करण्यासाठी स्लॅश आणि बर्न तंत्राचा अवलंब करावा? एका खाणी कंपनीचा विचार करा ज्याने पूर्वीच्या चुकलेल्या क्षेत्रात खुले खड्डा खणकाम केले आहे. जमीनदोष आणि पृष्ठभागाच्या पर्यावरणाची पुनर्संचयित करण्यासाठी कंपनीची नैतिक जबाबदारी आहे का? आणि मूळतः नैसर्गिक पर्यावरणाच्या तुलनेत मानवी पुनरुत्थित वातावरणाचे मूल्य काय आहे? नैसर्गिक वातावरणाच्या भागांचे प्रदुषण करणे आणि नष्ट करणे आणि ग्रहाच्या नैसर्गिक स्रोतांचा मोठा प्रमाणात वापर करणे मनुष्यासाठी नैतिकरित्या चुकीचे असल्याचे म्हटले जाते. जर ते चुकीचे असेल तर, हे केवळ एक स्थायी वातावरण (वर्तमान आणि भविष्यातील)मानवी कल्याणासाठी आवश्यक आहे का? किंवा असे वर्तन देखील चुकीचे आहे कारण नैसर्गिक पर्यावरण आणि/किंवा त्याचे विविध घटक त्यांच्या स्वतःच्या अधिकारांमध्ये काही मूल्ये आहेत जेणेकरून या मूल्यांचे आदर करणे आणि कोणत्याही परिस्थितीत संरक्षित करणे आवश्यक आहे? पर्यावरणविषयक नैतिकतेद्वारे तपासल्या गेलेल्या प्रश्नांपैकी हे आहेत. त्यापैकी काही विशिष्ट परिस्थितीत व्यक्तींना तोंड द्यावे लागणारे विशिष्ट प्रश्न आहेत, तर इतर गट आणि समुदायांद्वारे इतर वैश्विक प्रश्न आहेत. तरीही इतर नैसर्गिक वातावरणाचे मूल्य आणि नैतिक स्थिती त्याच्या मानवी-घटकाविषयीचे अजोड प्रश्न आहेत. पर्यावरणीय नैतिकतेवरील साहित्यात विचार करण्यासाठी पर्यावरण व सार्वजनिक आरोग्य हे महत्वाचे आहे. यासाठी मी “पर्यावरण व सार्वजनिक आरोग्य यांचा अभ्यास करणे” हा शोधनिबंध मध्ये विचार मांडलेले आहेत.

### २. पर्यावरण व मूल्य

पूर्वी म्हणजे इतर काही गोष्टींचा अर्थ म्हणजे गोष्टींचे मूल्य होय, तर दुसरे म्हणजे इतर गोष्टींच्या अर्थाप्रमाणेच उपयुक्त आहेत की नाही हे विचारात घेतल्याशिवाय गोष्टींचे मूल्य आहे. उदाहरणार्थ, काही फळांवर बॅट्ससाठी वादूय मूल्य असते, कारण फळांवर आहार देणे ही बॅट्ससाठी जगण्यासाठी एक संसाधन आहे. तथापि, बहुतेकांनी हे मान्य केले नाही की फळांचा स्वतःचा अंत म्हणून मूल्य असतो. आपण अशा व्यक्तीबद्दल विचार करू शकतो जो इतरांना ज्ञान मिळवण्यास इच्छुक असणाऱ्यांना महत्त्वपूर्ण महत्त्व देतो. तरीसुद्धा, अशा कोणत्याही मूल्याव्यतिरिक्त, सामान्यतः असे म्हटले जाते की एखाद्या व्यक्तीच्या रूपात, व्यक्ती म्हणून आंतरिक मूल्य असते म्हणजे जाते की एखाद्या व्यक्तीच्या रूपात, व्यक्ती म्हणून आंतरिक मूल्य असते म्हणजे, तिच्या संपर्काची स्वतंत्रपणे तिच्या किंवा इतरांच्या संपत्तीची पूर्तता करण्यासाठी तिच्या स्वतःच्या अधिकाराने मूल्य. दुसऱ्या उदाहरणासाठी, एखाद्या विशिष्ट वन्य वनस्पतीमध्ये वायूचे मूल्य असू शकते कारण ते काही औषधासाठी साहित्य किंवा मानवी निरीक्षकांसाठी सौंदर्याचा अनुभव यासारख्या इतर काही समस्यांस स्वतंत्रपणे त्याच्या संभाव्यतेत काही मुल्य असेल तर वनस्पती देखील अंतर्भूत आहे. कारण आंतरिकरित्या मौल्यवान मूल्य म्हणजे स्वतःला संपूष्ठात चांगले आहे, असे सर्वसाधारणपणे मान्य केले जाते की नैतिक एजंट्सकडून संरक्षित करण्यासाठी प्रथम प्रत्यक्ष नैतिक कर्तव्ये तयार किंवा कमीतकमी हानीकारक ते टाळतात (पहा. ओ नील १९६२ आणि जॅमिसन २००२ अंतर्गत मूलभूत तपशीलवार खात्यांसाठी). तथापि, बऱ्याच पारंपारिक पाश्चात्य नैतिक दृष्टीकोन मानववंशिक किंवा मानवी-केंद्रीत आहेत ज्यामध्ये ते केवळ मानवांना आंतरिक मूल्य प्रदान करतात (म्हणजे, आम्ही एखाद्या अर्थाने एक अर्थेद्विक म्हटल्या जाऊ शकतो)किंवा ते मनुष्याला महत्त्वपूर्ण महत्त्वपूर्ण मूल्य देतात मानवी स्तभावाचे संरक्षण किंवा संवर्धन किंवा मानवी-मानवतेच्या खर्चावरील कल्याण या गोष्टींना नेहमीच न्याय्य (अर्थात, आपण एका कमकुवत अर्थाने मानववंशीय असे म्हणू शकतो) च्या कोणत्याही मानवी-मानवी गोष्टींपेक्षा प्राण्यांपेक्षा जास्त आहेत.

### ३. निसर्ग व मानव

“निसर्गात सर्व गोष्टी विशेषतः मनुष्याच्या फायद्यासाठी बनविल्या आहेत” आणि असे मानते की नैसर्गिक नसलेल्या मानवी गोष्टींचे मूल्य केवळ वादूय आहे. सामान्यतः, मानववंशिक पद्धतींना मानवी-जनावरांच्या क्रूर वागणुकीत काय चुकीचे आहे हे स्पष्ट करण्यासाठी त्रासदायक ठरते, अशा प्रकारच्या उपचारांमुळे मनुष्यांसाठी वाईट परिणाम होऊ शकतात. इमॅन्युएल कांत (“कर्तव्यांवरील पशु आणि आत्मा”, व्याख्यानावरील आचारसंहिता)मध्ये, उदाहरणार्थ, कुत्राकडे क्रूरता एखाद्या व्यक्तीला एक असे वर्तन विकसित करण्यास प्रोत्साहित करू शकते ज्यामुळे मनुष्यांकडे क्रूरता कमी होईल. या दृष्टीकोनातून, मानवीय प्राण्यांसाठी क्रूरता

आंतरिकरित्या चुकीच्या, ऐवजी वाद्य वाजवी असेल. त्याचप्रमाणे, मानववंशशास्त्र बहुतेक वेळा पर्यावरणाचा विनाश (मानव-निर्मित) पर्यावरणातील काही अनौपचारिक चुकीबद्दल ओळखतो. अशा प्रकारचे विनाश आता आणि भविष्यात मानवजातीच्या कल्याणास नुकसान होऊ शकते, कारण आपले कल्याण हे सातत्याने टिकाऊ वातावरणावर अवलंबून आहे. उप-अनुशासनाच्या रूपात उभरले तेव्हा पारंपरिक मानववंशीय विचारसरणीला आव्हान देण्याद्वारे असे केले. पृथ्वीवरील इतर प्रजातींच्या सदस्यांना मानवांच्या मानले जाणाऱ्या श्रेष्ठ श्रेष्ठतेवर प्रश्न विचारला गेला. दुसऱ्या ठिकाणी, नैसर्गिक वातावरणास आणि त्याच्या मानवी नसलेल्या सामग्रीला आंतरिक मूल्य प्रदान करण्यासाठी तर्कसंगत वितर्काची शक्यता तपासली. तथापि, हे लक्षात घ्यावे की, क्षेत्रातील काही सिद्धांतज्ञांना नवीन, नॉन-एनथ्रोपेट्रिक सिद्धांत विकसित करण्याची आवश्यकता नाही. त्याऐवजी, ते ज्ञानी मानववंशकेंद्र (किंवा कदाचित अधिक योग्यरित्या म्हणतात, हुशार मानववंशीय विचारसरणी) म्हणून ओळखले जाऊ शकते त्या गोष्टीचे समर्थन करतात. थोडक्यात, विचार केला असता असे दिसते की आपल्या पर्यावरणाकडे असलेल्या नैतिक कर्तव्यांवरून मानवी रहिवाशांना त्यांचा फायदा मिळत असतो.

#### ४. सामाजिक धोरण

धोरणांसाठी नैसर्गिक धोरणे प्रदान करणे म्हणजे पृथ्वीच्या वातावरणाचे संरक्षण करणे आणि पर्यावरणाची अवस्था सुधारणे होय. ज्ञानी मानववंशीय विचार, ते तर्क देतात की, त्या व्यावहारिक हेतूसाठी पुरेसे आहेत आणि धोरणिकदृष्ट्या परिणामकारक पद्धतीने परिणामकारक परिणाम देण्यास आणखी प्रभावी आहेत, नॉन-एनथ्रोपेट्रिक सिद्धांतांपेक्षा, नंतरच्या सैद्धांतिक बोझामुळे गैर-मानव पर्यावरणामध्ये अंतर्भूत मूल्य आहे (सी.एफ.नॉर्टन १९६१, डी शालिट १९६४, लाइट अँड कॅट्झ १९६६). शिवाय, काही विवेकाधीन मानववंशशास्त्रज्ञ संभ्रमिक मानववंशशास्त्रीय म्हणू शकतात ज्याचा अर्थ असा आहे की आपल्या दिवसा-विचारांच्या विचारात नॉन-एनथ्रोपेट्रिक असणे हा उच्चस्तरीय मानववंशिक कारण आहे. असे समजा की मानव-मानवांवर अवलंबून असणार्या मानव-पर्यावरणाकडे एक दिवस-नसलेला मानव-मानवशास्त्रज्ञ अधिक सौम्यपणे कार्य करतो. यामुळे नॉन-एनथ्रोपेट्रिक विचारांना उत्तेजन देण्याचे कारणदेखील मिळते, ज्यांना नॉन-एनथ्रोपेट्रिक आंतरिक मूल्याने गिळण्याची कठिण कल्पना आहे. अशा प्रभावी धोरणास कारणीभूत ठरण्यासाठी एखाद्याने दुसऱ्यांपासून आणि स्वतःपासून स्वतःच्या व्यंग्यात्मक मनुष्यकेंद्रांना लपविण्याची आवश्यकता असू शकते. स्थितीचे परिणामस्वरूप काही अप्रत्यक्ष स्वरूपाच्या तुलनेत मांडले जाऊ शकते आणि समांतर समीकरणे आकर्षित करू शकतात.

#### ५. पर्यावरणविषयक नैतिकतेचा प्रारंभिक विकास

मानवाचा जन्म जरी निसर्गाच्या आणि एकोणिसाव्या शतकाच्या तत्त्वज्ञानाचे स्वरूप लक्ष केंद्रित केले असले तरी समकालीन पर्यावरणीय नैतिकता केवळ १९७० च्या दशकात एक शैक्षणिक शिस्त म्हणून उभी झाली. गेल्या पन्नास वर्षात नैसर्गिक वातावरणासह मनुष्यांच्या नातेसंबंधाविषयी प्रश्न विचारणे आणि पनर्विचार करणे १९६० च्या दशकात आधीच व्यापक प्रमाणात दिसून आले होते. विसाव्या शतकाच्या उत्तरार्धात मानवी आघात विस्फोट आणि गंभीर पर्यावरणीय संकटांचा सामना करावा लागला आहे. मानवाने जरी आपली वैयक्तिक प्रगती केली असली तरी तो या भौतिक जगामध्ये सुखा समाधानाने राहत असलेला दिसून येत नाही. जागतिक तत्त्वज्ञ व पर्यावरण तज्ञ राहेल कार्सनच्या मौन स्प्रिंग (१९६३) या संकल्पनेकडे लक्ष वेधून घेण्याजोग्या सुलभ कामांपैकी एक म्हणजे न्यूयॉर्क मॅगझिनमध्ये प्रकाशित झालेल्या अनेक निबंधांचा समावेश होता. ज्यात डीडीटी, अॅल्ड्रिन आणि डिल्ड्रिनसारख्या कीटकनाशकांनी खाद्यपदार्थांद्वारे कसे केंद्रित केले होते ते पीक उत्पादन आणि नफा वाढवण्याच्या उद्देशाने कमर्शियल फार्मिंग पद्धतींचे लक्ष्य, कार्सन भासते, पर्यावरणीय आणि सार्वजनिक आरोग्यावर एकावेळी प्रभाव पाडण्यास सक्षम आहेत. या निबंधांच्या आधारे विचार केला असता मानवाचे आरोग्य हे एक प्रकारची संकटच बनत चालले आहे. यासाठी पर्यावरण व आरोग्य यांचा सुसंवाद व मेळ घालणे गरजेचे आहे.

#### ६. पर्यावरण संकट

पर्यावरणीय संकटाच्या ऐतिहासिक मुळांवर (१९६७) अनेक उद्धृत निबंध (व्हाईट १९६७) मध्ये इतिहासकार लिन व्हाईट यांनी असा युक्तिवाद केला की जुदेओ-ख्रिश्चन विचारांच्या मुख्य पैलूंनी मानवी जीवनातील इतर सर्व प्रकारच्या जीवनावरील श्रेष्ठतेचे पालन करून निसर्गाचे अतिवृष्टीकरण केले आहे. पृथ्वी, आणि मनुष्याच्या वापरासाठी तयार केलेली सर्व निसर्ग दर्शविणारी व्हाईटची थीसिस धर्मशास्त्र, इतिहासात व्यापकपणे केलेली चर्चा केली गेली आणि काही समाजशास्त्रीय चाचणीच्या अधीन आहे तसेच तत्त्वज्ञांनी नियमितपणे चर्चा केली आहे (व्हिटनी १९६३, अटफील्ड २००१ पहा). त्याच्या थीसिससाठी तर्कशक्तीचे केंद्र चर्च फादर्स आणि बायबलचे कार्य होते, मानवी दृष्ट्या पृथ्वीवरील महत्त्वाच्या गोष्टी मानतात अशा मानववंशीय दृष्टिकोनास समर्थन देत होते. परिणाम, ते कोणत्याही अन्यायाशिवाय इतर कोणत्याही गोष्टीचा फायदा आणि त्यांचा फायदा घेऊ शकतात “देवाने आपल्या स्वतःच्या प्रतिमेत मनुष्य निर्माण केला, देवाच्या प्रतिरूपात त्याने त्याला निर्माण केले; देव त्यांना म्हणाला, “फलद्रूप व्हा, बहुगुणित व्हा आणि पृथ्वी व्यापून टाका; ती आपल्या सत्तेखाली आणा; समुद्रातील मासे आणि आकाशातील पक्षी यांच्यावर सत्ता गाजव. पृथ्वी. “त्याचप्रमाणे, थॉमस एक्विनास (सुमा कॉन्ट्रा अरेस्टीज, बीके ३, पीटी २, सी ११२) असा युक्तिवाद करतात की मानव नसलेल्या प्राण्यांना” मनुष्याच्या वापरासाठी आदेश दिलेला आहे”. व्हाईटच्या मते, ज्युडो-ख्रिश्चन विचारानुसार मानव अतुलनीय अलौकिक ईश्वराच्या प्रतिमेत तयार केले गेले आहेत, जे नैसर्गिकरित्या निसर्गापासून वेगळा आहे, तसेच विस्ताराने मानव स्वभावापासून स्वतःला वेगळे करते. एकुणच विचार केला असता पर्यावरण व सार्वजनिक आरोग्य हे एकाच नाण्याच्या दोन बाजू आहेत हे विसरून चालणार नाही.

**७. निष्कर्ष :**

१. पर्यावरणाचा सर्वांनी काळजीपूर्वक अभ्यास करणे गरजेचे आहे.
२. शेतीचे संवर्धन करणे गरजेचे आहे.
३. प्राण्यांचे प्रजाती यांचे महत्व समजून घेणे गरजेचे आहे.
४. सार्वजनिक आरोग्य हे महत्वाचे आहे.
५. सार्वजनिक मुल्य यांचा वापर करावा.
६. पर्यावरण विषयक नैतिकतेचा वापर केला पाहिजे.
७. आधुनिकतेचा वापर प्रभाविपणे केला पाहिजे.
८. पर्यावरण व विज्ञान यांचा उपयोग मानवाच्या कल्याणासाठी करावा.
९. पर्यावरण व मानव यांनी देश उभारण्यासाठी सहकार्य करावे.

**८. सारांश**

विज्ञानाशिवाय, ज्या पर्यावरणाची आपण आता उघडकीस आलो आहोत ती कदाचित समजू शकणार नाहीत. व्हाईट्स थीसिसचा मुद्दा असा आहे की, आधुनिक तंत्रज्ञानाचा आणि तंत्रज्ञानाचा आधुनिक प्रकार देण्यात आला आहे, तर जुदेओ-ख्रिश्चनिटी स्वतःच निसर्गाच अमर्याद शोषणास मूळ गहन पाठींबा देते. तरीही, व्हाइटने असा युक्तिवाद केला की ख्रिश्चनात्व (उदा. सेंट फ्रान्सिसच्या दृश्यांमधील)मधील काही अल्पसंख्याक परम्परा मानववंशीय मानवांमध्ये अडकलेल्या मुख्य प्रवाहाच्या “गर्विष्ठपणा” चे प्रतिरूप देतील.जवळजवळ त्याच वेळी, स्टॅनफोर्डे इकोलॉजिस्ट पॉल आणि अॅनी एहरलिच द पॉप्युलेशन बम (एहरलिच १९६८) मध्ये चेतावणी दिली की मानवी जनतेच्या वाढीमुळे ग्रॅरिअल लाइफ-सपोर्ट सिस्टमची व्यवहार्यता धोक्यात आली. नासाच्या निर्मितीमुळे आणि १९६८ च्या ख्रिसमसच्या वेळी झालेल्या जागेवरून पृथ्वीच्या विशेषतः शक्तिशाली प्रतिमेच्या विस्तृत प्रसाराने आणि सप्टेंबर १९७० मध्ये वैज्ञानिक अमेरिकनमध्ये वैशिष्ट्यीकृत केलेल्या पर्यावरणीय समस्येमुळे आणि इतर लोकप्रिय कार्यांमुळे उत्तेजित झालेल्या पर्यावरणीय समस्येची तीव्रता वाढली. येथे पहाणे सोपे आहे एक जिवंत, चमकणारा ग्रह जो अंतरिक्षमधून वाहून गेला आणि मानवतेने सामायिक केला, चमकणारा ग्रह जो अंतरिक्षमधून वाहून गेला आणि मानवतेने सामायिक केला, प्रदूषणाला बळी पडणारा एक मौल्यवान पोत आणि मर्यादित क्षमतेचा अतिउत्साहीपणा. १९७२ मध्ये डेनिस मीडेज यांच्या नेतृत्वाखालील एमआयटीच्या संशोधकांनी एक मर्यादा प्रकाशित केली. ही कार्ये गेल्या दशकातील उदयोन्मुख चिंतेच्या आणि स्पंदनापासून पृथ्वीच्या दृष्टिकोनातून निर्माण होणार्या कमकुवततेच्या भावनांच्या बऱ्याच मार्गांनी मांडली गेली. अभ्यासाच्या समालोचनामध्ये, संशोधकांनी लिहिले:

आम्ही शेवटी हे मान्य करतो की संधी किंवा आपत्ती याऐवजी योजनाबद्ध उपायांद्वारे समतोल आणि तर्कसंगत स्थितीपर्यंत पोहोचण्याचा कोणताही हेतुपुरस्सर प्रयत्न अंततः वैयक्तिक, राष्ट्रीय आणि जागतिक स्तरावर मूल्य आणि लक्ष्याच्या मूलभूत बदलावर आधारित केला पाहिजे.

**संदर्भ- ग्रंथ सूची**

१. अब्बास एस ए (२००२) पर्यावरण व उर्जा स्रोत, प्रिन्टिस हॉल इंडिया प्रकाशन, न्यू दिल्ली.
२. भाट, डी. एम. (२००३) जंगलाचे संरक्षण, युनिव्हर्सिटी प्रेस इंडिया.
३. बर्वे, सिद्धिविनायक(२०१३) पर्यावरणशास्त्र, ओरिएन्ट प्रकाशन मुंबई -४००००९आय एस बी एन:९७८:८११२५०:३२०८:३
४. कुलकर्णी, डी. आर (२०१०) पर्यावरण शिक्षण, विद्या प्रकाशन, नागपूर.
५. पाटील लता (२००८) व्यक्तिमत्त्वाची सूत्रे, प्रणव प्रकाशन, इचलकरंजी.
६. मुळे रा. श त उमाहे, वि. तु. (१९८७) शैक्षणिक संशोधनाची मूलतत्वे, नागपूर. महाराष्ट्र विद्यापीठ ग्रंथनिर्मिती मंडळ

**दैनिके- संदर्भ**

१. दैनिक पुढारी-२७/१२/२०१५ समन्यायी पाणी वाटपाचे आव्हान, बहारपुरवणी, माधवराव चितळे, कोल्हापूर
२. दैनिक लोकमत - २५/१२/२०१५ नदीकाठच्या गावांना प्रदुषित पाणी, अतुल आंबी, इचलकरंजी

**इतर संदर्भ शोधनिबंध**

१. जेल्स प्रिटी-अहवाल, २००६
२. सी.एफ.नॉर्टन अहवाल, १९९१
३. ओ.नील. अहवाल, १९९२
४. जागतीक राष्ट्रसंघ अहवाल, २०१६

**इंटरनेट संदर्भ**

1. [www.bnhs.org](http://www.bnhs.org)
2. [www.saconindia.com](http://www.saconindia.com)
3. [www.nic.in](http://www.nic.in)
4. [www.cseindia.org](http://www.cseindia.org)

## Analysis of Soil Samples From Various Places

Dr J K Dawle\*, A S Bondge<sup>1</sup>, K I Momin<sup>2</sup>, V B Suryawanshi<sup>3</sup>

\*Head, Department of Chemistry, M M Nilanga

1. Department of Chemistry, S M Shirur Anantpal

2. Department of Chemistry, R S M Latur

3. Department of Chemistry, K M C Khopoli

### Abstracts

The analysis of nutrient is done in order to measure the nutrient that is present in the soil and it provides all the necessary information that is required in order to set the target of nutrient application. **It also allows the detection and monitoring of the changes in the parameters of soil. The result depends on quality of soil samples.** In this paper, the soil samples collected from horticulture spot, lakeside, agriculture area are studied. For the estimation of total Nitrogen, available Phosphorus, available potassium and exchangeable Calcium and Magnesium the methods used are Kjeldahl method, Bray's or Olsen's method, Flame photometric method and EDTA titration method respectively.

**Keywords:** kjeldahl method, topsoil, fertilizer, flame photometric method, Bray's method, EDTA, soil sampling, extractant.

### Introduction

Nitrogen (N), potassium (K) and Phosphorus (P) are very essential for plant growth and also for the strengthening of reproductive parts, activation of enzymes and carbohydrate metabolism. Nitrogen and Phosphorus are not available to the plants directly. They are incorporated in the organic material. Potassium (K) is present in elemental form, exchangeable form or as a part of mineral lattices. Calcium (Ca) and Magnesium (Mg) interfere in soil activity as well as activate a number of plant enzyme systems. The deficiency of any of these elements has retarding effect on the growth of plant.

**1.1 Nitrogen** Nitrogen occurs in several forms: Nitrate ( $\text{NO}_3^-$ ) and nitrite ( $\text{NO}_2^-$ ) anions, ammonium ( $\text{NH}_4^+$ ) and organic compounds. For high production, the application of N fertilizers can be done. This can be determined after the estimation of soil Nitrogen content. If the soil Nitrogen content is low, the application of N fertilizers becomes indispensable. Adequate supply of this element is associated with the plant growth and the deep green plant color.

The excess of this element can delay the crop maturity and prolong the growth period. The soil which is deficient in Nitrogen has stunted plant growth and they show signs of chlorosis too. There should be a proper quantity and proportion of soluble N which can be absorbed by the crop. This quantity is influenced by some local site factors like rooting habits of crop, removal of nitrate by leaching, the status of moisture in that part of root zone where the Nitrogen resides and presence or absence of the residues of crop.

**1.2) Phosphorus** Phosphorus occurs in soil in both organic and inorganic form. The inorganic form is more important for the crop nutrition. Most of the P is absorbed by the plants as  $\text{HPO}_4^-$  and  $\text{H}_2\text{PO}_4^-$  ions or soluble organic phosphates. Availability of Phosphorus in soil is very variable because it depends on the mineral soil composition, organic materials and its rate of decomposition, local climatic conditions and the morphological properties of soil. The supply of P at the early vegetative growth phase strengthens its reproductive parts and formation of seeds. It can also hasten the maturity of plant and it is said to improve the resistance of certain fruits, vegetables and forages from disease. Its deficiency will lead to discoloration of older leaves and leaf edges.

**1.3) Calcium** It is present in the soil either as soluble  $\text{Ca}^{2+}$  on the base complex or as free Calcium carbonate ( $\text{CaCO}_3$ ). In temperate soil it is present in abundance but it is absent in highly weathered tropical soils. It has a double role in the fertility of soil. It acts as plant nutrient at the same level as N, P and Mg as well as a pH regulator.

**1.4) Magnesium** It is the constituent of chlorophyll molecule, related to the metabolism of Phosphorus. It also activates number of plant enzymes. It is absorbed by the plant roots as  $\text{Mg}^{++}$  ion. If the soil has deficiency of Mg then the plant grown in such soil will become pale yellow and then turns brown and necrotic.

**1.5) Potassium** It is present in the soil in different forms. K in the soil solution which is in equilibrium with exchangeable  $\text{K}^+$  is difficult to distinguish from it, the exchangeable  $\text{K}^+$  that is affected by the content of clay, mineral decomposition intensity and the fertilizer's quantity is also a form of Potassium in soil. The requirement of plant for K is high relatively because plants absorb it in higher amount than other nutrient. The deficiency of K leads to Chlorosis or necrosis.

### Experimental Section

**1.6 Sites used for soil sample collection:** all the soil samples were collected from different sites located in Latur. Four types of soil samples were collected.

A.) soil sample from horticulture spot. B.) soil sample from lake side. C.) soil sample from Mountain. D.) soil sample from agricultural area.

1.7 Soil sampling: The top soil samples were taken from 0-10 cm of depth at four equidistant positions in each plot. When the sampling was done, the surface of soil in all plots was dry.

1.8 Estimation of soil nutrient:

A. Total nitrogen is estimated by kjeldahl method

B. Available Phosphorus is estimated by two methods: Bray's method which is the best method for acidic soils and olsen's method which is best for neutral and alkaline soils.

C. Available Potassium is estimated by Flame photometric method

D. Exchangeable Calcium and Magnesium is usually determined in the neutral ammonium acetate extract of soil. The extraction is carried out by shaking the soil and the extractant of mixture is followed by either filtration or centrifugation. Then the determination of Ca and Mg is done either by EDTA titration method or by the atomic absorption spectrophotometer after removal of organic matter and ammonium acetate

## Conclusion

Nutrient analysis is the measurement of nutrients present in the soil which is removed from the soil using an extracting solution. The nutrient analysis of soil will provide the necessary information to set the target of nutrient application. It is then used to set up the target of nutrient application which is then used to calculate the rate of manure and fertilizer application. The results of tests from regular field sampling will allow the detection and monitoring of the changes in soil parameters (pH, nutrients, salinity) with the time.

It is must for the soil analysis results to be interpreted within the context of the expected yield response for the crop which is to be grown under the specific management and environmental conditions. The results depend on the quality of soil samples collected and also the strategy of sampling that is used. If the samples are poor it will lead to inaccurate nutrient recommendations.

## References

- Hundal, H.S., Rajkumar, Dhanwindar Singh and Machandra, J.S. (2006) Available nutrient and heavy metal status of soils of Punjab, North-west India. *Journal of the Indian Society of Soil Science*, 54 : 50-56.
- Jackson, M. L. (1973) *Soil Chemical analysis*, Prentice Hall of India Private Ltd. New Delhi.
- Jibhakate, S.B., Raut, M.M., Bhende, S.N. and Kharche, V.K. (2009) Micronutrient status of soils of Katol tahasil in Nagpur district and their relationship with some soil properties. *Journal of Soils and Crops*, 19 : 143-146.
- Kadao, S.H., Prasad J. and Gajbhiye, K. S. (2002) Micronutrients status in Banana growing soils of Wardha district of Maharashtra. *Journal of Maharashtra Agricultural University*, 27 : 117-119.
- Lindsay, W.L. and Norvell, W. A. (1978) Development of DTPA soil test for Zn, Fe, Mn and Cu. *Soil Science Society of America Journal*, 42 : 421-428.
- Mali, C.V. and Raut, P.D. (2001) Available sulphur and physico-chemical characteristics of oil seed dominated area of Latur district. *Journal of Maharashtra Agricultural University*, 26 : 117-118.
- Meena, H.B., Sharma, R.P. and Rawat, U.S. (2006) Status of macro and micronutrients in some soils of Tonk district of Rajasthan. *Journal of the Indian Society of Soil Science*, 54 : 508-512.
- Murthy, R.K. and Murthy, C.A. S. (2005) Distribution of some available micronutrients in black and red soils of Karnataka. *Mysore Journal of Agricultural Science*, 39 : 57-63.
- Ram, J., Singh, S.P. and Gopal, R. (1999) Available micronutrient in relation to soil properties in the soils of Bundelkhand. *Journal of Maharashtra Agricultural University*, 24 : 112-114.
- Ramamoorthy, B. and Bajaj, J. C. (1969) Available N, P and K status of Indian soils. *Fertilizer News*, 14 : 24-26.
- Sharma, R.P., Megh Singh and Sharma, J.P. (2003) Correlation studies on micronutrients vis-à-vis soil properties in some soils of Nagpur district in semi-arid region of Rajasthan *Journal of the Indian Society of Soil Science*, 51 : 522-527.
- Shinde Y. R. (2007) Physico-chemical properties and nutrient availability of soils of Udgir and Deoni tahsils of Latur district M.Sc. (Agri.) thesis submitted to MKV, Parbhani.
- Vijaya kumar M., Lakshmi, G.V. and Madhuvani, P. (2013) appraisal of soil fertility status in salt affected soils of ongole division, Prakasam district of Andhra Pradesh. *Journal of the Indian Society of Soil Science*, 61 : 333-340.
- Waikar, S.L., Malewar, G.U. and More, S.D. (2004). Elemental composition of Humic and Fulvic acid in soils of Marathwada region of Maharashtra. *Journal of Maharashtra Agricultural University*, 29 : 127-129.
- Yadav, R.L. and Meena, M.C. (2009) Available micronutrient status and their relationship with soil properties of Degana soil series of Rajasthan. *Journal of the Indian Society of Soil Science*, 57 : 90-92

## Solid Waste Management in Municipal Corporation

**Arzoo G. Bagwan**

Department of Environment Management,  
CSIBER, Kolhapur- 416004, Maharashtra, India.

### Abstract

*One of the major problem faced by the cities and towns now-a-days is related to municipal solid waste. This is due to rapid population growth, urbanization, industrialization, commercialization and modern life style. In India, in last few decades, a significant increase in municipal solid waste has been recorded. This is due to the economic development and rapid population growth rate. Maharashtra, being one of the big state in India has grown very fast in last few decades. On an average 100-150 gm of solid waste is generated in small towns & villages and about 500-550 gm is generated in big cities. In Maharashtra, cities like Mumbai, Pune, Nashik, etc. are fastest growing cities and has developed a number of employments to people which has changed their living style. This has also created a large number of solid waste problems in these big cities. Due to this, it has lead to many health issues and spread of diseases. The objective of this paper is to provide and overview about municipal solid waste management, from its generation till its disposal and find a solution to this growing problem.*

### Introduction

Solid waste is defined as the any unwanted or undesirable solid materials generated from various human activities. These solid waste materials are the leftovers from various human activities which when left untreated can cause health hazards. These materials cannot be reused directly by the society so needed to be recovered and treated so that it can be reusable by the people. Various human activities as created these solid wastes which can cause risk to health and the environment (Saxena et al., 2010). Due to the fast-growing industrialization and urbanization and change in life style has given solid waste a rapid growth. Generally, solid waste consists of domestic, industrial, commercial, construction and demolition, agricultural, institutional, public gardens and also other miscellaneous waste. Domestic and commercial waste together is mostly considered as urban waste (Syed, 2006).

Municipal solid waste generally consists of waste from household, construction and demolition sites, sanitation residue, waste from public gardens and waste from streets. Municipal solid waste, according to the Municipal Solid Waste (Management & Handling) Rules 2000, is defined as “commercial and residential waste generated in a municipal or notified area in either solid or semi-solid form excluding industrial hazardous waste but including treated biological waste”. Municipal solid waste generally includes biodegradable waste like kitchen waste, green waste and other degradable waste; recoverable waste like plastics, rubbers, metals, paper, glass, cardboard, etc. and inert waste like construction & demolition waste, slit, debris, etc. (Neha Gupta et al., 2015; Jha et al., 2011). According to the recent MPCB report on municipal solid waste, approximately 23,449.66 MT/day is generated in Maharashtra State. This waste is classified in various classes as – corporation (87.0%), Class A (4.0%), Class B (4.0%), Class C (4.0%) and other (1.0%) (MPCB, 2016).

Due to the rapid industrialization and rapid population growth has lead to generation of a vast amount of municipal solid waste but there have been no proper techniques for the collection and disposal of this waste. Most of the time this waste is thrown on road side and out of the public bins which leads to various diseases and unpleasant environment in that area. This causes due to the unawareness in the public and poor management technique of this waste.

### Classification of municipal solid waste:

Municipal solid waste is generally classified as follows:

#### Biodegradable waste:

Biodegradable waste consists of organic waste which can be broken down from complex to simple form with the help of microbes and other living organisms. This waste consists of kitchen waste from houses, green waste like waste from gardens and other biodegradable waste. With rapid urbanization and changing life style, the amount of waste generation has increased. The characteristic of this waste depends of the food habits and the changing life style of people (R. Rajput et al., 2009). This biodegradable waste can be converted into of the organic manure with the help of microorganisms and other living organisms. This manure is rich in nutrients and can be used in farms as a biofertilizer.

#### Non-degradable waste:

Non-degradable waste consists of materials like plastics, paper, cardboard, metal scraps, glass, rubbers, etc. These materials cannot be degraded naturally. Due to modernization of the society this kind of waste is generated in a great ton of amounts. These materials can be reused or recycled by segregation of waste followed by recovery process. Non- degradable waste also consists of inert waste generated by construction and demolition works. This waste can be disposed of on land.



**Health issues related to municipal solid waste:**

Disposal of municipal solid waste on open land fields, improper management of solid waste, unawareness and poor management system has lead to various health issues. The open and overflowing garbage filled public bins has become home for many street animals and also breeding place for insects and mosquitoes. This leads to generation of various diseases to humans as well as leads to unpleasant environmental condition in that particular area. Many bacterial and viral diseases are spread through these insects, flies and mosquitoes, some of which even can lead to serious health problems of death. Landfilling of waste can lead to leaching of waste water into the groundwater bodies which can lead to water born diseases. Open dumping fields are more hazardous as these sits are at high risk of catching fire and spreading of unpleasant odour and air born diseases. Even the workers are more prone to health hazards as they are in direct contact with the waste and can also lead to infections. Animals feeding on this waste an also develop various diseases especially the cattle animals like cows and buffalos. The direct dumping of this waste into the water bodies can pollute the water bodies also leads to increase in death rate of aquatic animals, as seen in recent years. These aquatic animals are used as food by the people, thus the toxicants are transferred into the human bodies which causes serious health issues.

**Solid waste management:**

Solid Waste Management is associated with the control on waste generation till its disposal with the help of various techniques and principles which can reduce health hazards and environmental degradation. The basic objectives of solid waste management are- protection and promotion of environmental quality, protection of public health, supporting the efficiency and productivity of economy (S. C. Santra, 2013).

Management of municipal solid waste has become a great issue in recent years. In March 1995, the Ministry of Environment and Forest and the Central Pollution Control Board with the help of municipal authorities developed a new strategy for MSWM and formed rules for Management of Municipal Solid Waste and Biomedical Waste in 1996. Later on, the government formed State Pollution Control Board and formed separate rule for biomedical waste, hazardous waste and municipal waste. under the Environment Protection Act of 1986, "Municipal Solid Waste (management and handling) Rules 2000" was drafted in 1999 and implemented in 2000, which gives detail of the responsibility of the state and the central government to manage and create awareness amongst people about this municipal solid waste issue (S. C. Santra, 2013).

Also in recent years as an awareness and management of waste, government has developed a program called "Swachh Bharat Mission". It was launched by the Prime Minister Narendra Modi on the birth anniversary of Mahatma Gandhi on October 2<sup>nd</sup>, 2014 which became the major initiative in solving this solid waste issue. The mission of this program was to make India a clean nation by the 150<sup>th</sup> birth anniversary of Mahatma Gandhi in the year 2019. This mission has implemented on the government to strongly focused on this management of municipal solid waste.

**Waste disposal methods:**

The disposal techniques used for disposal of municipal solid waste are as followed:

**1. Open dumping:**

Open dumping disposal method is most common method practice from many years in India. The municipal solid waste collected from various sectors is directly dumped in open land field without any recovery or treatment. As the waste is dumped on an open field, it causes increase in health risk and also unpleasant environment.

**2. Landfilling:**

Landfilling technique is generally seen in urban areas for dumping of solid waste. Unlike open dumping ground, waste is dumped in a pit dug in land and the pit is then covered by the soil layer to prevent breeding of flies, mosquitoes and other street animals. Landfilling generally has many problems as all type of waste is dumped on same land and leaching of water into the ground causes a problem of groundwater pollution.

**3. Sanitary landfilling:**

Sanitary landfilling is used as an alternative to landfilling which can solve the problem of leaching. This method of landfilling is more hygienic and build by lining the pit with impermeable material which can prevent leaching of water from waste.

**4. Composting:**

Composting is the process of degradation of organic matter in the presence of air with the help of various microbial action. It is the most common and cost-effective method of disposing wet waste. The degradable waste from municipal waste is generally segregated and is send to composting processes where the microorganisms converts the complex material into simple form and the end product formed is compost manure which can be used as organic manure in agricultural fields as an alternative to fertilizers.

### 5. Incineration:

Incineration is the method in which the waste is burned in furnace on high temperature. In this method the recyclable material is separated and the rest is burned. The end product of incineration process, i.e., ash is highly toxic material which is then needed to be disposed off properly. Incineration process generally causes air pollution and also the problem of toxic ash disposal.

### 6. Vermicomposting:

Vermicomposting is also one of the best alternative for the disposal of wet waste. It is one of the safe and hygienic way for the disposal of municipal organic waste. In this method generally, earthworms are used instead microorganisms to convert complex organic matter into simple form. This method is more commonly used in many Indian cities for the disposal of wet municipal waste.

### The 5 r's principles for waste management:

This principle was developed for the management for solid waste from its generation till its disposal. These principles are much helpful in reducing waste at its source of generation and also helps in proper management and handling of solid waste. The 5 R's principles are as follows:

- **Refuse:**  
As the word itself suggest that to refuse the use of non-degradable materials like plastic, instead start using bags made from cloths. This helps in reducing large amount of waste generation.
- **Reduce:**  
Reduce simply means to lessen the amount of waste generation. For e.g., carrying own shopping bags instead of buying, using rechargeable batteries instead of disposable ones, etc.
- **Reuse:**  
As the name suggest, start reusing the material we have instead of throwing then and buying new ones. This helps in reducing much amount of solid waste generation. For e.g., reuse of plastic bags for different purpose instead of buying new ones can reduce the plastic pollution, reuse of water bottles, etc.
- **Recycle:**  
This means recycling of old into new one which can be used again. In the recent year many do-it-yourself techniques has been developed for recycling and reducing the waste. For e.g., recycling of old cloths into various things like – bag, mobile cover, pillow cover, etc., recycling of cardboard and plastic bottles into some showpiece items, recycling of various other items like- coke cans, news papers, e-waste, glass, scrap metals, etc. by sending them back to its respective manufacturers which helps in reducing solid waste.
- **Recover:**  
This is the last step of the 5R's principle. After following all the above steps, the remaining trash is again send for the process of recovery in which the remaining trash is examined and if there is any recoverable material, it is then separated and send for recycling process. This helps in reducing amount of waste generation.

### Case study: kagal municipal corporation, kolhapur.

A case study was carried out in Kagal city, Kolhapr. The project has been carried out on municipal solid waste management by the Kagal Municipality named as “A Step Towards Zero Waste”. This project was stared in 2016 by the municipal corporation of Kagal city. The capital cost of this project is about 3.57 cr. including all construction, machinery and vehicles. Door to door collection of waste is done by the Ghanta Gadi from Kagal City and Kagal MIDC area. Nearly 8 tons of waste is collected daily as dry and wet waste. The dry waste is send for recovery and recycle process whereas wet waste is converted into manure.

The segregated biodegradable waste is manually feed into feeding and crushing tank with 1:1 proportion of waste and water. Here crushing and recrushing is performed. Then it is passed to digester. The capacity of digester is 4 tons. The digester container consists of heaters inside which helps in maintain the temperature about 37<sup>0</sup> C. About 90,000 lit. culture is introduced in digester at the stat of project. This microbial culture generates methane gas. After digestion process the excess water is removed from the tank which can be reused in the digestion process. After this process, compost having 3 times enriched nutrients is produced which is then used in farms as biofertilizer.

After anaerobic digestion, methane gas is produced which comes to balloon. This balloonis made up of neoperin, as it does not burst when it is full. Then the methane gas is send to the scrubber where other gases is separated from methane. Also, the moisture from gas is removed. Then the pure methane gas received by compressor and stored. Daily 240 m<sup>3</sup> methane gas is generated. This gas is then used to generate electricity of 500 KW. This electricity is used for lighting 200-300 streetlights in city.

**Result and conclusion:**

The findings of the paper fulfil the objective of this paper which gives an overview about the solid waste management in municipal corporations. It also describes the various new techniques and the major initiatives of the Government of India has taken towards this growing issue and creating awareness amongst people. The case study of Kagal Municipal Corporation also gives an overview of the municipal solid waste management techniques which recently has been started by the municipal corporations.

**References:**

1. Nag & K. Vizayakumar, 2005. Environmental Education and solid waste management. New Age International Pub. Ed.-I. Res. 15.
2. Jha, A.K. Singh., S.K. Singh, G.P., & Gupta, P.K., 2011. Sustainable municipal solid waste management in low income group of cities: a review. *Int. Soc. Trop. Ecol.* 52 (1): pp. 123-131.
3. Jha, M.K., Sondhi, O.A.K., & Pansare, M., 2003. Solid waste management — a case study. *Indian J. Environ. Prot.* 23 (10): pp. 1153-1160.
4. MPCB, 2016. Implementation of solid waste management rules, 2016. Maharashtra Pollution Control Board, Mumbai, India.
5. N. Gupta, K.K. Yadav, & Vinit Kumar, 2015. A review on current status of municipal solid waste management in India. *J. Env. Sci.* 37: pp. 206-217.
6. Ranjith K. Annepu, Nickolas J. Themelis, Sanley-Thompson, 2012. Book- “Sustainable Solid Waste management in India”.
7. R. Rajpur, G. Prasad & A.K Chopra, 2009. Scenario of solid waste management in present Indian context. *Caspian J. Env. Sci.* 2009, Vol 7 (1): pp. 45-53.
8. Saxena, S., Srivastave, R.K., & Samaddar, A.B., 2010. Sustainable waste management issue in India. *IUP J. Soil Water Sci.* 3 (1): pp. 72-90.
9. S. C. Santra, 2013. *Environmental Science*, New Central Book Agency (P) Ltd. Ed. 3.
10. S.T, Ingle & D.S. Malil, 2000. Solid waste management system for Kolhapur city – Maharashtra. *Pollution Research Enviromedia* 19 (2): pp. 185-189.
11. Syed, S., 2006. Solid and liquid waste. *Emirates J. Eng. Res.* 11 (2): pp. 19-36.

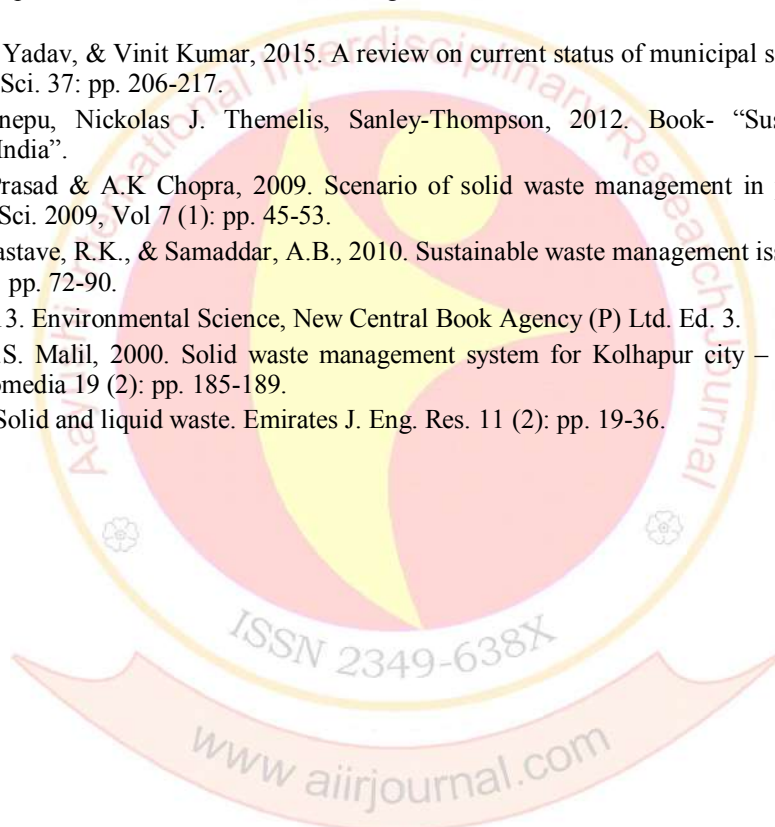

## Synthesis, Characterization of ZnO/CdO Material Prepared By Chemical Bath Deposition Method

D. A. Lavate, V. J. Sawant, A. S. Khomane

Department of Chemistry,  
Government Rajaram College, Kolhapur,  
affiliated to Shivaji University, Kolhapur,  
Maharashtra, 416004, India.

### Abstract:

ZnO/CdO nanoparticles were synthesized by chemical bath deposition method using appropriate complexing agent. The synthesized nanoparticles were characterized by X-ray diffraction, EDAX, Scanning electron microscope. X-ray diffraction results confirmed the formation of ZnO/CdO nanoparticles. The surface morphological analyses of ZnO/CdO were also studied.

### Introduction:-

Now days, semiconductors have much more attention due to their extensive properties. The various semiconductors are used such as CdO[1], ZnS[2], ZnO[3], CdS [4] etc. The previous literature reported that semiconducting metal oxides have optoelectronic, catalysis and biological activities [5]. The use of ZnO/CdO have much more attention in past few years due to presence of its optical and electrical properties[5].

ZnO nanoparticles has large band gap(3.3eV)[6]. The band gap of ZnO nanoparticles can be reduced by doping CdO[7-8]. The several methods are used to prepare ZnO/CdO nanoparticles like Sol-gel method [9], Vapour phase transport [10], and Spray Pyrolysis technique [11]. But out of these methods Chemical bath deposition is one of the best method because of its simplicity and inexpensive to unit cost basis.

In the present work, ZnO/CdO nanoparticles were prepared by Chemical bath deposition method using monochloroacetic acid complexing agent for slow release cations of Zn and Cd. The prepared material analysed for ZnO, CdO and ZnO/CdO composites.

### Synthesis of ZnO/CdO

10 ml of 0.25M ZnSO<sub>4</sub> solution & 0.25M CdCl<sub>2</sub> was taken in a beaker. The solution of 0.1 M monochloroacetic acid is added to the solution as a complexing agent. Ammonia and NaOH were used to maintain pH of solution. Then whole reaction mixture was diluted to 50 ml of distilled water. The glass substrates were placed vertically and reaction mixture was stirred. The prepared thin film on ZnO/CdO was annealed at 400 °C for 2 hrs and their structure was investigated.

### Result and Discussion

#### X-Ray diffraction:

XRD spectrum of pure ZnO and CdO nanoparticles shows hexagonal and Cubic crystal structure respectively. Some extra peaks are shown because of composites material.

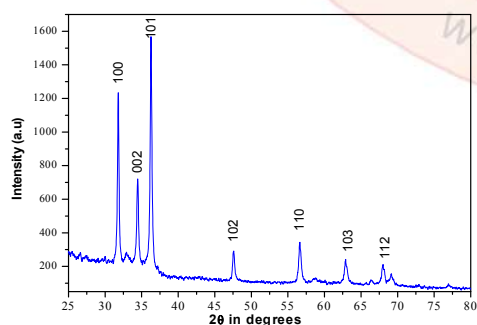

Fig.1 XRD spectrum of ZnO nanoparticles

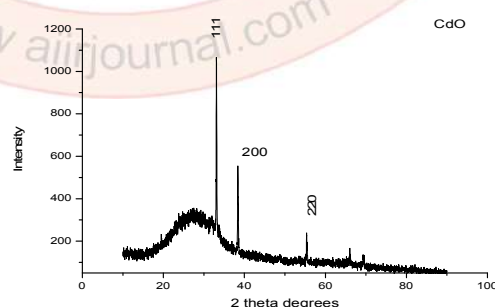

Fig.2 XRD spectrum of CdO nanoparticles

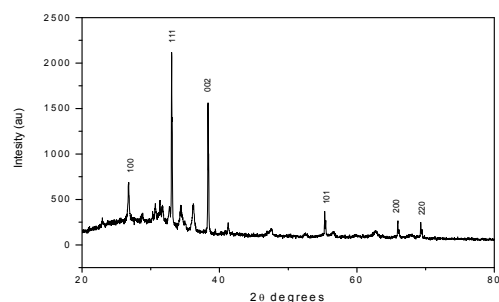

Fig.3 XRD spectrum of ZnO/CdO nanoparticles

**Surface morphology and Elemental analysis-**

SEM study is used for surface morphological analysis and is shown in the Fig.4. Shows those particles are deposited with cactus leaflet shape.

In EDAX we got desired elemental composition for  $Zn_xCd_{1-x}O$  Fig 5 Table 1.

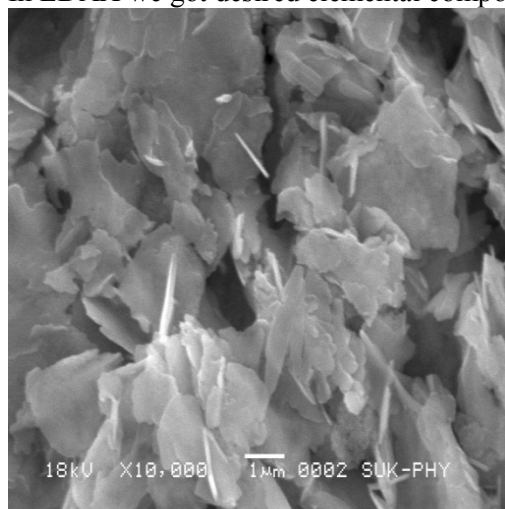

Fig.4.SEM micrograph of ZnO nanoparticles

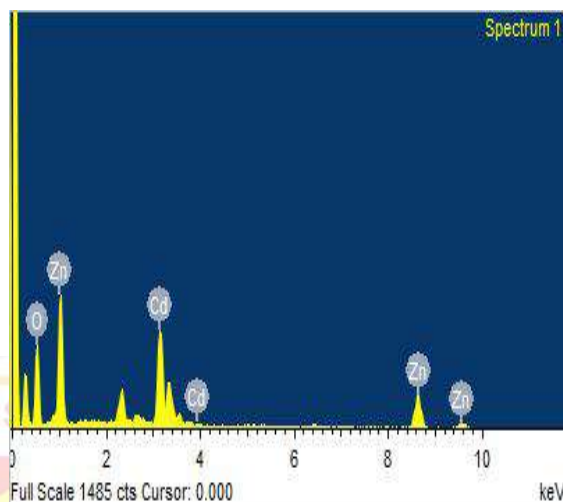

Fig.5 EDX of ZnO/CdO nanoparticles

Element	Weight	Atomic %
O K	44.95	81.25
Zn K	24.81	10.98
Cd L	30.23	7.78
Total	100	

Table.1 Elemental Composition

**Conclusion:-**

The thin film of  $Zn_xCd_{1-x}O$  prepared by chemical bath deposition method by using monochloroacetic acid as a complexing agent.

**References:-**

- 1] T. Gujar, U.Shinde, W.Kim, K Jung, C Lokhande and O .Joo ,Appl. Surface Sci. ( 2008) 254, 3813
- 2] A.Pudov, J .Sites and T .Nakada, , Japan J Appl. Phys. (2002) 41, L672
- 3] T. Saeed and O Bien P, Thin Solid Films (1995)271, 35
- 4] H. Khallaf , I .Oladeji and L. Chow, Thin solid films(2008),516,5967
- 5] P.H.C Camargo, K.G Satyanarayana, F.Wypych, Mater.Res., (2007)12, 1
- 6] P.Senthil Kumar, M. Selvakumar, B. Bharathi, S. Karuthapandian, S. B. Alakumar, RSC Advance 4 (2014) 32977-32986
- 7] C. Xu, L. CaO, G.Su, W.Liu, Y.Ku, X.Qu, J.Hazard Material 176(2010) 807-813
- 8] Z.L.Liu, J.C.Deng,j. J.Deng, F.F.Li, Material science Engg. B 150 (2008) 99-104
- 9] A.Y. Trinch, Lix, W. Wlodarski, S. Kaciulis, L .Pandolfi, S .P Russo, Sens. Actuators A,(2003),108
- 10] k Yu, Y.Zhang, R.Xu, D.Jiang, L. Luo, Q .Li, Z .Zhu and W. Lu, Solid state commun. (2005), 133 , 43-47
- 11] S.H. Keshmiri, and M..R. RoknAbadi, Thin Solid Film, (2001), 382, 230-234

## Nyctanthes Arborescens: As a Natural Colorant in Drug Products

**Damini Powar**

TatyasahebKore College of Pharmacy, Warananagar  
Tal-Panhala, Dist- Kolhapur MS 416113

### Abstract:-

Pharmaceutical excipients are the backbones of pharmaceutical industries. The present investigation involves extraction of the color from the Nyctanthes flowering stalk by solvent extraction method using distilled water, chloroform and Physical characterization done. Two extract were studied to identify the presence of specific phytoconstituents in them. It was found that aqueous extract showed presence of alkaloid, glycoside, saponin, tannin, triterpenoid, phenols and chloroform extract contain only alkaloids. It can be concluded from the present work that aqueous extract of Nyctanthes flowering stalk shows significantly colorant property when compared with chloroform extract. Here we established a new method and techniques to process Nyctanthes Flowering stalk color to be used as pharmaceutical coloring agent.

**Key words:** -Nyctanthes flowers stalk, Microwave Assisted Extraction, Pharmaceutical coloring aids.

### 1.Introduction:-

Throughout the world, the use of natural-type food colors continues to increase. Many consumers believe, even without valid proof, that natural colors are less harmful and therefore more acceptable than synthetic dyes<sup>1</sup>. Color is an important factor in the acceptability of food product, food quality is first adjudged on the basis of its color. Ayurveda is one of the oldest systems of medicine that uses plants and their extracts for treatment and management of various diseased states. Nyctanthes arborescens is well known Indian medicinal plant. Phytochemicals have been reported for significant, hepatoprotective, antileishmaniasis, antiviral, antifungal, antipyretic, antihistaminic, antimalarial, antibacterial, anti-inflammatory, antioxidant activities.

#### 1.1 Objective:

Preparation of two types of extracts i.e. chloroform and aqueous extract, comparing between them as a coloring agent. Use of Nyctanthes flowering stalk extract as a coloring agent in syrup and granules.

#### 1.2 Plan of Work:

- Collection of flowering stalk from the Nyctanthes Arborescens tree from surrounding area of T. K. C. P. Warananagar and Kodoli
  - Preparation of Extracts of Nyctanthes Arborescens flowering stalk by using various solvent like water, chloroform.
  - Physical characterization of coloring matter like by determination of solubility
  - Determination of UV- Visible  $\lambda_{max}$  followed by thin layer chromatography.
- Determination of stability of coloring matter in various pH, temperature, light

#### 1.3 Literature Review:

**Kenmogne S.B. (2014):** compared the conventional and microwave assisted extraction methods. Result showed that the inhibition percentage of analgesic compounds from *Xinemia americana* obtained by microwave method was improved as compared to conventional soxhlet and maceration methods.

**Dindaet al (2008):** reported methods and techniques to process annatto seed color to be used as pharmaceutical coloring agent in solid and liquid oral dosage form. Color extracted from seeds by different methods.

## 2 Materials and Methods

**2.1 Materials:-** Dried Nyctanthes flowering stalk, Distilled water, Chloroform, Silica Gel G, Ethyl acetate, Methanol, Sucrose, Peppermint oil.

**2.2 Equipments:-** Microwave oven (with distillation unit), analytical balance, Shaker Incubator, Rotatory Evaporator, Hot air oven, UV visible Spectrophotometer.

### 2.1.1 Methods:-

#### 2.1.2 Collection and authentication of plant:-

Flowering stalk of Nyctanthes arborescens was collected (in the month of September to November) from surrounding area of T. K. C. P. Warananagar and Kodoli. The flowering stalk was shed dried for one month and used for the extraction. The plant was positively identified and confirmed by botanist H.O.D. of Botany department Y. C. College Warananagar, Mr. S. Y. Jadhav



Fig(1): Collection and drying of Nyctanthes flowering stalk

### 2.1.3 Extraction of color from nyctanthes flowering stalk

#### 2.1.3.1. Nyctanthes flowering stalk extract (Solvent extraction method)

##### Preparation of Aqueous extract:

- Aqueous Extract-

Maceration : In this process shade dried flowering stalk was placed in glass stoppers container with 150 ml distilled water and 10 ml chloroform(preservative); allowed to shake at room temperature for period of 1 week with agitation in Shaker incubator. Extract was filtered using muslin cloth. And get concentrated by using rotator evaporator.

- Alcoholic Extract-

Microwave-assisted extraction (MAE): It is relatively new extraction technique which utilizes microwave energy to heat the solvent and increase mass transfer rate of the solute from sample matrix into the solvent chloroform extract was done by MAE method by setting parameters as 400 W , for 30 min.<sup>23</sup>



Fig(2) Rotatory evaporator



Fig(3) Aqueous extract



Fig (4) Microwave oven with Distillator



Fig(5) chloroform extract

#### 1.2.3.2 Thin Layer Chromatography:-

Madewith a cover glass and it was left for a few minutes and saturate the air in the chamber. Mobile phase :Ethyl acetate: Methanol (99:1)The  $R_f$  value for component is then worked out using the formula:

- $$R_f = \frac{\text{distance travelled by extract}}{\text{distance travelled by solvent}}$$

#### 1.2.3.3 Chemical Testing:-

##### Test for Alkaloids

1. Dragendorff's reagent: 2. Mayer's reagent:

3. Wagner's reagent:

4. Hager's reagent: Test for Triterpenoids:-Salkowski test:

**Test for Glycoside:Test forTannin:Test for Saponin: Test ForPhenoles:** Test sample is treat with neutral  $FeCl_3$  indicate violet colour<sup>25</sup>

#### 1.2.3.4 Determination of $\lambda_{max}$ :-

- Absorbance of solution were measured using UV-Visible Spectrophotometer in visible light spectra 400-800nm.

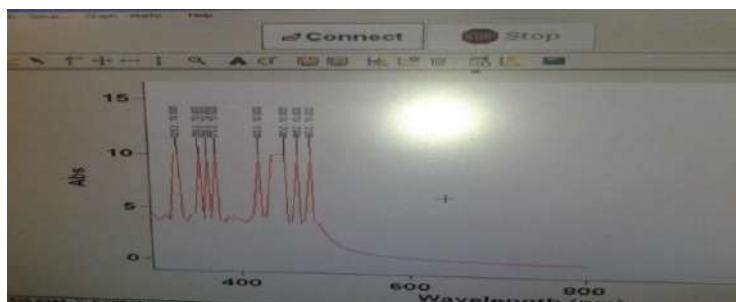
Fig(5):  $\lambda_{\max}$  of aqueous extract

### 1.2.3.5 Preparation of calibration curve of Nyctanthes extract:

To get solution containing  $2\mu\text{g/ml}$ ,  $4\mu\text{g/ml}$ ,  $6\mu\text{g/ml}$ ,  $8\mu\text{g/ml}$ ,  $10\mu\text{g/ml}$ , as final solution. Then the absorbance was measured in UV-visible spectrophotometer at 423nm against distilled water as blank.

### 1.2.3.56 Stability study of Nyctanthes flowering stalk color extract in oral liquid dosage form :- Simple Syrup and Paracetamol Syrup

- Each bottle containing 30ml simple syrup was added in 5 different bottles in that various proportion of aqueous extract (0.01ml, 0.02ml, 0.03ml, 0.04ml ) was added. 0.04 ml of aqueous extract was selected for further study. These formulation was subjected to different light source like tungsten lamp and sunlight for stability study purpose. Chloroform extract was added in one bottle contains simple syrup 30ml showed oily globules formation.



Fig(6): Formulation of Simple Syrup

### 1.2.3.6 Evaluation of Nyctanthes flowering stalk extract as coloring agent in oral solid dosage form (granules): Table No-1

Sr.no	Ingredients	Quantity
1	calcium lactate	600mg
2	starch powder	5%
3	Isopropyl alcohol	q. s.

The granules were prepared by dry granulation method.

## 2. Results:

### 2.1. Thin Layer Chromatography of nyctanthes color

In this method the Nyctanthin appear as yellow spots with  $R_f$  value of about to 0.55





Sr. no.	Test Name	Aq. extract	Chloroform extract
1.	Test for alkaloids	(+ve)	(+ve)
2.	Test for glycoside	(+ve)	(-ve)
3.	Test for triterpenoids	(+ve)	(-ve)
4.	Test for tannin	(+ve)	(-ve)
5.	Test for saponin	(+ve)	(-ve)
6.	Test for phenols	(+ve)	(-ve)

Fig(8): TLC Characterisation



2.2 Chemical Evaluation Test: Table No.-2 Fig (9): Chemical test

### 532.3. Calibration curve for Nyctanthes color:

The absorbance was measured in a UV spectrophotometer at 423 nm against distilled water as blank. The absorbances obtained were tabulated as in Table 5.2 and calibration curve was plotted and shown in Figure 10

The calibration curve showed good linearity and regression coefficient was 0.997 ( $r^2$  value).

**Table 3: Spectrophotometric data for the estimation of Nyctanthes flowering stalk color**

Sr.No	Concentration $\mu\text{g/ml}$	Absorbance
1	2	0.1058
2	4	0.1823
3	6	0.2723
4	8	0.3657
5	10	0.4643

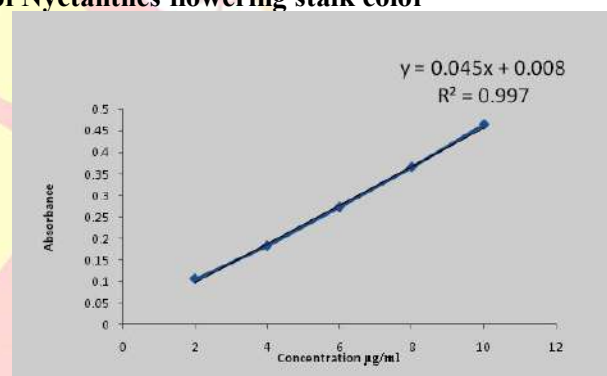

**Fig.(10) Calibration curve of Nyctanthes flowering stalk color**

### 2.4 Stability study of syrup:-

The initial color was noted and after 6 hours and 24 hours again absorbance was determined there was no color change but only absorbance was found to be decreasing, this was more in the case of syrup placed in direct sunlight it may due to tungsten lamp stability testing showed simple syrup and paracetamol syrup were less stable than the direct sunlight. in direct sunlight showed small decrease in absorbance which may be overcome by using container such as amber colored glass bottles for package.

For Simple Syrup, Table no .4 For Paracetamol Syrup, Table no

light source	Initial absorbance	absorbance after 6 hrs	Absorbance after 24 hrs
Tungsten Lamp	0.5515	0.5087	0.4792
Sunlight	0.5515	0.5924	0.5463

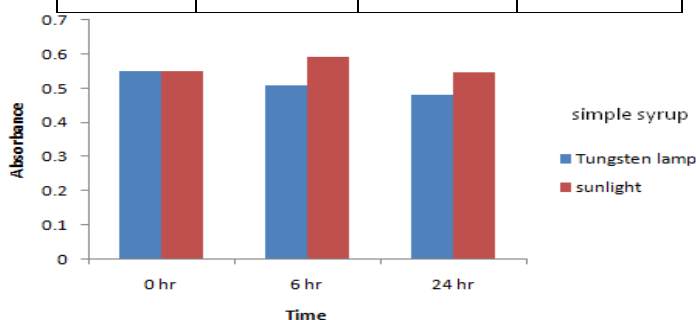

light source	Initial absorbance (mg /ml)	Absorbance after 6 hr (mg /ml)	Absorbance after 24 hr (mg /ml)
Tungsten Lamp	1.0125	0.7077	0.7250
Sunlight	1.0125	0.8281	0.7675

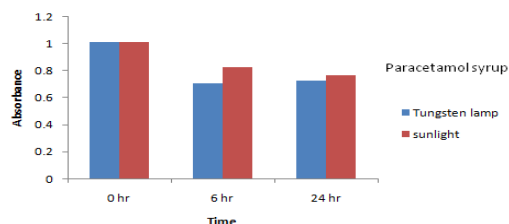

Fig(11): graph for Stability study of simple syrup Fig(12): graph for Stability study of paracetamol syrup

### 2.5. Evaluation of Nyctanthes flowering stalk color extract in oral solid dosage form of 0.04% concentration (granules):

The granules were prepared and evaluated its bulk density, tapped density, flow rate, Carr's Index, Hausner's ratio, angle of repose( $\theta$ ).

Table no:-5

Weight of granules	11.974 g
Bulk volume	28 ml
Bulk density	0.42 g/ml
Tapped volume	23 ml
Tapped density	0.52 g/ml
Flow time	11 sec
Flow rate	1.08 g/sec
Carr's Index	19.23%
Hausner's Ratio	1.23
Angle of repose	17.96°

It was found that evaluation tests for granules were passes as per standards.

### 3. Conclusion:-

- The present investigation involves extraction of the color from the Nyctanthes flowering stalk by solvent extraction method using distilled water, chloroform.
- Physical characterization of the coloring matter was done like determination of solubility which showed that it is soluble in distilled water.
- Two extract were studied to identify the presence of specific phytoconstituent in them. It was found that aqueous extract showed presence of alkaloid, glycoside, saponin, tannin, triterpenoid, phenols and chloroform extract contain only alkaloids.
- color was tested to determine the  $\lambda_{max}$  of the Nyctanthin color, stability of the Nyctanthin color was tested.
- The stability of color solution was determined by placing the color in various light sources like tungsten lamp, sunlight and testing after 6hours, 24hours.
- This shows that the Nyctanthin color is light sensitive color and should be stored in the light resistant container.

It can be concluded from the present work that aqueous extract of Nyctanthes flowering stalk shows significantly colorant property when compared with chloroform extract. Thus it can be use as coloring agent in Pharmaceutical dosage formulation.

### 4. Bibliography:-

1. Lancaster F E, Lawrence JF. High-performance liquid chromatographic separation of carminic acid,  $\alpha$ - and  $\beta$ -bixin, and  $\alpha$ - and  $\beta$ -norbixin, and the determination of carminic acid in foods. J of Chromatography A 1996; 732: 394-98.
2. Oluwaniyi O O, Dosumu O O, Awolola GV, Abdulraheem AF. Nutritional Analysis and studies of some natural and synthetic food colorants. American J Food Technology. 2009; 4(5): 218-25.

## Challenges in Environmental Ethics and Research Ethics

**Dr. Dinesh D. Satpute**

Assistant Professor, Department of English,  
Y. C. Warana Mahavidyalaya, Warananagar

### Abstract

The planet known as the Earth has natural Environment. It is a blessing to entire living organism. It is only planet highly life cycle protective in the planetary system known to human being. Attempt has been made to seek the life of the planet but no perfect answer is found to human abilities. Yet, man as the most curious being on the Earth trying to find it out.

If we see the history of human civilization from early Stone Age, we come to know that man has always scratched the parts of this beautiful Earth at different places to make the life more and more comfortable without paying heed to the loss of unique natural environment.

From his journey to be a savage to civilized one, he realized another branch of knowledge emerged known as Ethics to keep the group of people together and developed personal and mass Ethics. Human investigation further evolved different branches of Ethics such as Business Ethics, Social Ethics, Political Ethics, Research Ethics and many others. All holy religious scriptures discussed values and morals to sustain human race with love and peace.

After the emergence of Aurveda in India and Allopathy in other parts of the world-with a Medical Science a great loss of Herbs, plants, forests began to take place. Research in Human life brought wonders. But we started to misuse it. Due to ICT and internet the ratio of pure research decreasing day by day, as people adopted plagiarism.

In the present paper attempt is made to seek the challenges and remedial measures in the loss of Environment and Research Ethics.

Key Expressions: Environment, Ethics, Values, Morals, Indian Scenario, Global Context, Research Ethics, Challenges etc.

The man developed various branches of knowledge through his consistent investigation of natural changes. The Science based on purely experimental efforts to know them found him to be the beneficial one making his life happier than before and then the rat race of making life happier and the happiest is there on the cost of losing the beautiful Environment on the Earth.

The purpose of research is to discover answers to questions through the application of scientific procedures. The curiosity in human being is a natural instinct for which man raises questions to self and others and makes attempt to seek solutions on the cost of spending his and others' time, energy, etc till he satisfies his self and in doing so what happens is the law of Einstein Energy gets converted from one to another form premature affecting natural conditions and phenomenon.

Man is less worried to these changes or he doesn't have anything at his disposal to compensate the natural loss that takes place in his research efforts. Possessed with the selfish motive despite of adverse results, he only act to scratch the environment and as per his action and positive results to his efforts, he further goes on doing the same activity in greeter quantity for greater advantage and in this unending cycle he loses his awareness of the loss of environment.

At this juncture, in the era of ICT, man is obsessed with the idea of virtual reality. Father when son is in the home in one room instead of having a dialogue with him he just sends a message of desire in his brain cells. Face to face biological dialogue that was taking place previously has been lessening day by day and the issue of values, morality, and ethics come on anvils among the so called civilized societies blaming each other.

The main aim of research is to find out the truth which is hidden and which has not been discovered as yet. What makes the people to undertake research? This is a question of fundamental importance. The possible motives may be either one or more of the following:

1. Desire to get along with its consequential benefits;
2. Desire to face the challenges in solving unsolved problems;
3. Desire to get intellectual joy of doing some creative work;
4. Desire to be of service to society;
5. Desire to get respectability etc. (Kothari C. R.) [2]

All progress is born of enquiry against doubts resulting inventions. If we seriously reflect to above purpose and aims of research, we will realize that there is one or the other desire behind as per desired results

where whether individual is equally serious or not about ethical purpose and aims to be considered. Obviously, it depends on approach of researcher. Here question arises what is ethics? Dictionary meaning as referred in Wikipedia moral principles that govern a person's behaviour or the conducting of an activity or the branch of knowledge that deals with moral principles.

synonyms: moral code, morals, morality, moral stand, moral principles, moral values, rights and wrongs, principles, ideals, creed, credo, ethos, rules of conduct, standards (of behaviour), virtues, dictates of conscience.

Ethics or moral philosophy is a branch of philosophy that involves systematizing, defending, and recommending concepts of right and wrong conduct.<sup>[1]</sup> The field of ethics, along with aesthetics, concerns matters of value, and thus comprises the branch of philosophy called axiology.<sup>[2]</sup> Ethics seeks to resolve questions of human morality by defining concepts such as good and evil, right and wrong, virtue and vice, justice and crime. As a field of intellectual inquiry, moral philosophy also is related to the fields of moral psychology, descriptive ethics, and value theory.

Three major areas of study within ethics recognized today are:

1. Meta-ethics, concerning the theoretical meaning and reference of moral propositions, and how their truth values (if any) can be determined
2. Normative ethics, concerning the practical means of determining a moral course of action
3. Applied ethics, concerning what a person is obligated (or permitted) to do in a specific situation or a particular domain of action [1].

The base of all human progress is natural environment which is on the anvil of existence on the name of research. Why do we want research if we are going to destroy the valuable Environment which is not at our disposal to create as we all are mere part, a small digit of whole beautiful universe? Giving thought to the issue is a need of present time. It means the researcher must observe the ethics to preserve the natural environment while he carries any research may be implied or theoretical.

Let's see what it means an Environment to us all.

1. Environment is everything that is around us. It can be living or non-living things. It includes physical, chemical and other natural forces. Living things live in their environment. They constantly interact with it and adapt themselves to conditions in their environment.

Natural environment · Natural resource · Animal · Electromagnetic radiation [3]

2. An ecosystem (also called as environment) is a natural unit consisting of all plants, animals and micro-organisms (biotic factors) in an area functioning together with all of the non-living physical (a biotic) factors of the environment. [4]

Water on Earth · Atmosphere, climate and ... · Life · Ecosystems

3. The surroundings or conditions in which a person, animal, or plant lives or operates.

"Survival in an often hostile environment"

synonyms: habitat, territory, domain, home, abode; More

4. The natural world, as a whole or in a particular geographical area, especially as affected by human activity.

"The impact of pesticides on the environment"

synonyms: the natural world, nature, the living world, the world, the earth, the ecosystem, the biosphere, Mother Nature, Gaia; More

The above meanings of Environment which are driven from the universal acceptance show that it is creation of nature and of not a so called being known as human being, and therefore we have not any kind of right to destroy it for our greedy desires in different spheres of life. Ethics are realized only by us not any other living organisms. Why do we need to realize them? Obviously, other beings follow the laws of nature and they are worthy to enjoy natural justice. Man violets laws of nature and hence suffer in the hands of nature losing his exposures.

No doubt, conversion of energy from one form to the other is inevitable phenomenon on this living planet. Man has been taking bold step showing his willingness to be converted to other form not naturally but artificially by adopting any means and easiest one is to cut breathing adopting unnatural means. Is it indeed a progress? Is it indeed a civilization? Not, at all. It is attempt of escape from intolerance.

The varieties of diseases in human life are sheer mistake of unnatural response to nature. We are the only being disturbing life cycle and no one else. We have not made our life inhabitable, but the other beings trying to live naturally. Breaking the natural rules we replace them by making our own useful to be superior to other living organisms. We are killing animals as our food, cutting forests and developing animal sanctuaries to preserve wildlife.

Environmental ethics is the part of environmental philosophy which considers extending the traditional boundaries of ethics from solely including humans to including the non-human world. It exerts

influence on a large range of disciplines including environmental law, environmental sociology, ecotheology, ecological economics, ecology and environmental geography.

There are many ethical decisions that human beings make with respect to the environment. For example:

- Should humans continue to clear cut forests for the sake of human consumption?
- Why should humans continue to propagate its species, and life itself?
- Should humans continue to make gasoline-powered vehicles?
- What environmental obligations do humans need to keep for future generations?
- Is it right for humans to knowingly cause the extinction of a species for the convenience of humanity?
- How should humans best use and conserve the space environment to secure and expand life?
- What role can Planetary Boundaries play in reshaping the human-earth relationship? [5]

### Conclusion

Both Environment and Research are the crucial issues in Human life facing the challenges of Human Ethics. Human world on the Earth forgetting self made Ethics to regulate life, creating challenges before the Environment and field of manmade Research, only for the sake of material development. In this era of ICT, man has increased the speed of life. At certain juncture, he finds himself to be tired of these all material pleasures. However, his greed doesn't allow him to reflect on the issues. At Global level attempts are made in different summits to stop the destruction of the Earth (i.e. Vasundhara). The spirit of global seriousness is limited up to participating nations group together in summits period. Coming back to own nation, conveniently so called statesmen forget well being of the mankind due to sheer material greed.

Therefore, the present study suggests to entire mankind to ponder over the issues of Environment destruction and Research for infinite greed on the ethical point of view, otherwise the days are not far when mankind will suffocate on this Earth and will become unable to breath naturally and manmade ventilators will not be able to help us. Let's stop scratching the Earth for entire living being sake, our natural survival.

### References:

1. <https://en.wikipedia.org/wiki/Ethics>.
2. Kothari C. R., Research Methodology, Wishwa Prakashan, New Delhi, 2003 P: 29-30.
3. Natural environment - Wikipedia
4. [https://en.wikipedia.org/wiki/Natural\\_environment](https://en.wikipedia.org/wiki/Natural_environment)
5. [https://en.wikipedia.org/wiki/Environmental\\_ethics](https://en.wikipedia.org/wiki/Environmental_ethics)



## Occurrence of Macrophytes in Godavari river in and around Nanded – waghala city, Maharashtra

Dipali Sable<sup>1</sup> and Anuradha Osawar<sup>1</sup>,

<sup>1</sup>School of Earth Sciences,  
Swami Ramanand Teerth Marathwada University,  
Nanded, Maharashtra, India

### Abstract:

*The present study deals with the commonly occurring macrophytes in Godavari River in Nanded waghala city. Hydrophytes were studied during January to March 2015 to identify macrophytes. In the present study altogether 16 species representing 15 families belonging to four groups such as 2 free floating weeds, 6 submerged weeds, 2 rooted submerged weeds and 6 emergent weeds were found.*

Keywords: macrophytes, weeds, river

### Introduction:

Aquatic weeds are those plants growing in or near water and complete at least a part of their life cycle in water resources (Joshi P.P., 2012). The river water is integral constituent of aquatic plant life and one of the most important natural resources. A multitude of life for plant, particularly aquatic species is totally depending on water to carry out its vital functions. The river Godavari is a larger water storage reservoir of Marathwada covering major parts of Nanded district and meant for the domestic, irrigation, industrial and agricultural uses. The aquatic macrophytes are important structural and functional components in most of ponds and rivers and have a pronounced effect on the ecosystem.

Wetlands are diverse ecosystems that link people, wildlife and environment in special and interdependent ways through the essential life support functions of water (Maltby and Barker, 2009). Aquatic macrophytes are also known to respond to the quality of water in which they grow and can be used for monitoring the water body (Dewanji and Matai, 2000). The aim of present study is to identify macrophytic plant vegetation in the Godavari River in and around Nanded waghala city.

### Materials and Methods:

Hydrophytes are aquatic plants grow partially or completely in water. Macrophytic plants are large enough to be seen with the naked eye and are found in the shallow zones of lakes or rivers. This shallow zone is called the littoral zone and is the area where sufficient light penetrates to the bottom to support the growth of plants. The terms aquatic macrophyte refers to a diverse group of aquatic plants and encompasses flowering vascular plants, mosses, ferns, and macro algae (Gettys, et. al., 2009). The 1987 COE Manual defines hydrophytic vegetation is “ the sum total of macrophytic plant life that occurs in areas where frequency and duration of inundation or soil saturation produce permanently or periodically saturated soils of sufficient duration to exert a controlling influence on the plant species present.”

Aquatic plants can usually be categorized into four main types; Free floating hydrophytes Rooted hydrophytes with floating leaves, Submerged floating hydrophytes, Rooted submerged hydrophytes, Rooted emergent hydrophytes.

### Study area:

The Godavari is the second longest river in India after the river Ganges. It starts in Maharashtra and flows for 1,465 kilometers into the Bay of Bengal via the states of Telangana and Andhra Pradesh. It forms one of the largest river basins in India. Nanded is one of the historical places in Marathwada region of Maharashtra State. It is situated between 18° 15' to 19° 55' N latitude and 77° 7' to 78° 15' E longitude. The district Nanded situated on southeast fringes of the state demarcating boundaries of Andhra Pradesh and Maharashtra. The district lies in the basin of Godavari.

The entire study region receives the monsoon rains generally commence in early June and continue up to September. About 75% rainfall is received during monsoon while 16% through the south-west monsoon during the months of October and November. The pre-monsoon showers contribute about 7% and the remaining 2% is generally during short winter season. Deep black soils have limited distribution along the bank of Godavari. The climate in the district is very dry and summers are exceedingly hot.

The survey work explored the macrophyte diversity along Godavari river in Nanded city. In this aquatic macrophytes were observed particularly in seven sites viz; Vishnupuri dam, Nagina Ghat, Nav Ghat, Wajegaon pool, Hingoli Bridge, Shikarghat, Shankhterth. These seven sites were selected on account of availability aquatic macrophytes.

## Location map of study area

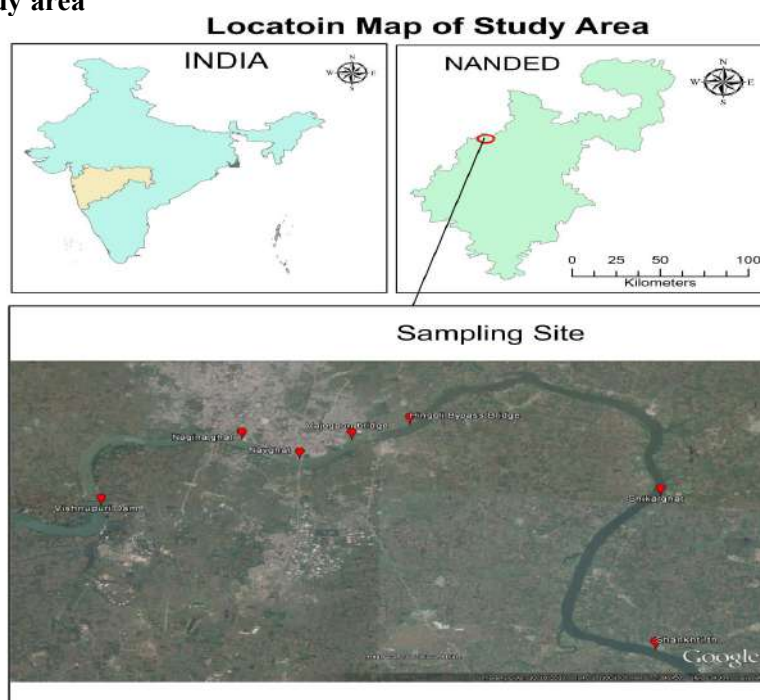

## Sampling Points

Seven points along Godavari river in Nanded city studied were as follows:

1. **Vishnupuri dam:** The dam constructed on the Godavari, this is one of the largest project in Marathwada region. This project is situated near Asarjan village; approximately 8 k.m. from Nanded city. The Vishupuri village is located on the edge of the city about 40 km of water column upstream, which, apart from its irrigation and drinking water functionalities offer a tremendous potential for recreational and inland water transport.
2. **Nagina Ghat:** Nagina ghat is situated 3km far from Nanded city. It is polluted area; the water gets mixed with household wastewater in city.
3. **Nav Ghat:** Nav Ghat is situated 4km far from Nanded city. It is also polluted area; the water gets mixed with household wastewater in city.
4. **Wajegaon pool:** This area is situated out of city area. Its 6 km far from Nanded city. Wajegaon pool situated on the bank of Godavari River.
5. **Shikarghat:** Shikarghat is situated on the bank of river Godavari on the distance of 10 to 12 km from Nanded city. It is an ideal site for the growth of macrophytes. The river is deep and water is rich with sewage and industrial effluents.
6. **Shankhteerth:** Shankhteerth is a village located 2 km towards east from district head quarters Nanded. This village also located on bank of Godavari river.
7. **Bypass road Hingoli Bridge:** It is situated out of city. It is also polluted area. This is industrial area, so the water is more polluted.

**Collection of Macrophytes:** The aquatic macrophytes were collected for the period of 3 months January to March 2015. In present study monthly survey was made. Seven sampling points chosen for identifying hydrophytes occur in the periphery of the Godavari River in Nanded city. The collected samples were brought to the laboratory in polyethylene bags and separated species wise.

**Identification of Macrophytes:** Macrophytes in shallow waters were collected directly while those from deeper water with the help of long handled hook. The samples were thoroughly cleaned with fresh water and distilled water for removal of soil and other extraneous particles. The product were cut into small pieces and save from the herbarium. The macrophytes were identified using standard available literature (Cook, 1996). The identification of aquatic plants was done with the help of standard books and monographs like, Biswas and Calder (1953).

**Results:** During the survey 16 macrophytes are recorded, which are as follows:

Free Floating macrophyte species in river waters are Lemna and Nymphaeoides. Submerged macrophytes represented by 6 species, Ceratophyllum, Cabomba, Limnophylla, Utricularia, Najas, Rotala. Rooted

submerged macrophytes are 2 species viz. Hydrilla, Potamogeton. Emergent Macrophytes are represented by 6 species. They remain firmly fixed in the bottom substratum but their top regions are exposed. Emergent species like Alternanthera, Polygonum, Ipomea, Cyperus, Scirpus, Typha. The dominant macrophytes present in Godavari River are Hydrilla, Rotala and Polygonum.

### Conclusion:

The aquatic plants observation study is intended to support other research in wetlands and in particular, to assure the continuing of ongoing long term ecological program. Presently the fresh water aquatic weeds are directly or indirectly more helpful for food and shelter to reservoir fishery at Godavari river.

*Acknowledgement:* We acknowledge UGC-SAP for meeting the partial expenditure to carry out this work and also the school of Earth sciences, Swami Ramanand Teerth Marathwada University, Nanded for support and encouragement.

### References:

1. Alex James, EOS Ecology, (January 2013). A review of the ecological effects of macrophyte management in soft-bottomed waterways, Waikato regional council, Private bag 3038, Waikato mail centre, HAMILTON 3240.P.12.
2. Ambast, R.S (1991): The Ganga-A Scintific study. (EDS: C.R.Krishnamurthy,K.S. Bilgrami, T.M. Das and R.P. Mathur) Northern book Centre, New Delhi; 161-165.
3. Armstrong, W. (1967). The use of polarography in the assay in higher of oxygen diffusing from roots in anaerobic media. *Physiol, plant.*, 20, 540-553.
4. Armstrong, W. (1997). Aeration in higher plants. *Adv. Bot.Res.*, 7, 225-331.
5. Biswas, K. and Calder, L. C. (1984) Handbook of common water and marsh plants of India and Burma, xvii 216, Bishensingh Mahendra palsingh [Dehradun].
6. Cook, C.D.K. (1996). Aquatic and wetland plants in India, Oxford University press. London.
7. Dewanji, A. and Matai, S. s of water quality(2000): Aquatic weeds as indicator of water quality. In: M. Yunus, N. Singh and L.J. de Kok (Eds), Anvironment Stress: Indication mitigation and Eco-conservation, kluwer Academic publication, Boston, pp. 251-258.
8. Dhembare, A.J. and Pondhe, G.M.(1997). Correlation of Ground Water Parameters of Pravara Area, Maharashtra State, India. Vol.1.2 (1 and 2): 32-33.
9. Gettys, L.A., Haller, W.T. and Bellaud, M.2009. Biology and control of aquatic plants. A best management practices Handbook, 2009. First published in the United States of America in 2009 by Aquatic Ecosystem Restoration Foundation, Marietta, Georgia, Printed in Gainesville, Florida, USA ISBN-O-615-32646-7.
10. Gupta, O.P., (1991): Aquatic weeds and their control in India, FAQ plant prot. Bull.24(3): 76-82.
11. Harney, N.V. 2014 Macrophytes Biodiversity of Dudhala Lake of Bhadrawati, District- Chandrapur (M.S.), India. *Asian Journal of Multidisciplinary Studies*. Volume 2, Issue 4,P.p 69-72.
12. Henry-Silva, G.G.; Camargo, A.F.M. Interacoes ecologicas entre as macrofitas aquaticas flutuantes *Echhornia e pistia statioles*. *Hoehnea*, V.32,N.3,P.445-452.
13. Hugh Dawson, NERC CEH-Dorset, UK, Guidance for the field assessment of macrophytes of rivers within the STAR dissertation ( 2002 ).
14. J.Chris Houg, Norman Elvin, Dreek Tilley; Raiparian/Wetland dissertation Information Series No.21 (May 2007) Wetland plants: Their function, Adaptation and relationship to water levels.
15. Joshi P.P , 2012.Study on Diversity, Taxonomy and Impact of Macrophytes on the Fresh water resources of Yavatmal District, Maharashtra, India. *International Research of Environmental Sciences*, Vol.1 (5), P p 1-5.
16. Kiran, B.R., Patel, A.N., Vijaya.K. & Puttaiah, E.T. (2006) Aquatic macrophyte in fish culture ponds at Bhadra fish farm, Karnataka,. *J.Aqua. Biol.* 21(2): 27-29.
17. Maltby E and Barker T (2009). *The Wetlands Handbook* first edition ( Blackwell publishing, Oxford).
18. Maynard, L, and D.Wilcox. 1997. Coastal wetlands of the Great lakes back ground paper for the State of the lake Conference (SOLEC). Environment Canada EPA 905-D-96-001C, Chicago and Toronto. S in minesota. *Am. Midland. Nat.*, 34: 402-420.
19. Mc Vea,C. & Boyd, C.E. 1975. Effect of water hyacinth cover on water chemistry phytoplankton and fish in ponds. *Jounal of Environmental quality*. 4, pp. 375-378.
20. Melzer, A. (1981): verednerunger der macrophyten vegetation des. Stranberger seas and there Indikatorische Bedeutung. *Limnologica*,13: 449-458.
21. Mukund Dhore, Manik Dhore, Dinesh Dabhadkar., (2012) Environmental Impact of Macrophyte on some Fresh Water Bodies in Washim District, Maharashtra, India. *International Journal of Scintific and Research Publication*, volume.2, Issue 1, P.p.1-4.
22. National Research Council (NRC). 1995. Wetlands, characteristics and boundaries. National Academy Press, Washington DC, 307 pp.
23. Palmer, C.M. (1980): *Algae and water pollution.*: Castle house publication Ltd., England.
24. Pandit, A.K. (1984): *J. Environment Mangement*; 18: 73-88.
25. Peiro, O. F.F.; Alves, R. G. Levantamento preliminary da entomofauna associated add a macrofitas aquaticas da regioa litoral de ambient lenticos. *Revista Uniara*, n.15, p. 177-188, 2004.



26. R. V. Tijare. 2011. Study Of Macrophytic Vegetation Present In Theletic Waterbodies Of Gadchiroli, M.S. (INDIA). Golden Research Thoughts ISSN: 2231-5063 Vol I, Issue IV.
27. Rama Rao. K., Ramakrishna. N and Amravati. D 2014 Checklist Of The Aquatic Macrophyte Flora Abundance In Lower Manair Dam At Karimnagar Dt. Andhra Pradesh, India. IOSR Journal of Environmental Science, Toxicology and Food Technology (IOSR-JESTFT) e-ISSN: 2319-2402, p- ISSN: 2319-2399. Volume 8, Issue 5 Ver. III.P.p 11-20.
28. Reddy, K.R., Sacco, P.D., Graetz, D.A., (ampbell, K.L. and Sinchair, L.R.(1982): Water treatment by an aquatic system: Nutrient removal by resources and flooded fields. Environ management.,6: 261-271.
29. Shashikant R.Sitre., 2013. Assessment of Macrophyte Bio-Diversity of a Freshwater Reservoir of Bhadravati Tehsil in Chandrapur District. Online International Interdisciplinary Research Journal, {Bi-Monthly}, ISSN2249-9598, Volume-III, Issue-III, P.p 78-81.
30. Shimoda, Michiko (1984) Macrophytic communities and their significance as indicator of water quality in two ponds in the Sajao basin, Hiroshima prefecture, Japan, Hikobia (9): 1-14.
31. Simpson, R.L., R.E. Good, R. Walker, And B.R. Frasco. 1983. The role of Delaware River freshwater tidal wetlands in the retention of nutrients and heavy metals. Journal of Environmental Quality 12:41-48.
32. Singh, J.P., Yadhav, P.K. and Singh, ion on algal and aquatic macrophytes. IJEP.; 8(11): 839-842.
33. Tiwari Vijay Jagdishprasad.,2014. Biodiversity of Aquatic Plants of Shivnibandh Lake of Sakoli Tehsil of Bhandara District of MS, India Int. J. of Life Sciences, 2014, Special Issue A2, P.p 211-213.
34. United States Environmental Protection Agency ( EPA 843-F-01-002b September 2001).
35. Varshney, C.K. 1981. Macrophytes as indicators of water quality in WHO workshop on biological indicators and Indices of Environment pollution, Hyderabad Indian Cent. Ed. Prood. Cont. Water.Poll., Osmania University.
36. Wikipedia Encyclopedia.
37. Willmer, P., Stone, G.& I. Jhonston, I. 2000. Environmental physiology of animals. Blackwell science Ltd, USA.
38. Wilson, C.E.S.J. Darbyshire and R. Jones. 2007. The biology of invasive alien plants in Canada. 7. Cabomba Caroloniana A. Gray. Can. Jan. Plant Sci. 87; 615-638.

#### Appendix I: Tables

**Table No. 1: Free floating macrophytes**

Sr. No.	Name	Common Name	Family
1.	Lemna	Duckweed	Lemnaceae
2.	Nymphoides	Crested floating heart	Menyanthaceae

**Table No. 2: Submerged Macrophytes**

Sr. No.	Name	Common Name	Family
3.	Ceratophyllum	Hornwort/Coontail	Ceratophyllaceae
4.	Cabomba	Fishgrass	Cabombaceae
5.	Limnophilla	Asian ambulia	Plantaginaceae
6.	Najas	Naiad	Najadaceae
7.	Utricularia	Bladderwort	Nymphaeaceae
8.	Rotala	Rotala	Lythraceae

**Table No. 3: Rooted Submerged Macrophytes**

Sr. No.	Name	Common Name	Family
9.	Hydrilla	Oxygen weed	Hydrocharitaceae
10.	Potamogeton	Curly leaf pondweed	Potamogetonaceae

Table No. 4: Emergent Macrophytes

Sr. No.	Name	Common Name	Family
11.	Typha	Common cattail	Typhaceae
12.	Cyperus	Fragrant flat sedge	Cyperaceae
13.	Scirpus	Bulrush	Cyperaceae
14.	Ipomoea	Bush Morning Glory	Convolvulaceae
15.	Alternanthera	Joyweed	Amaranthaceae
16.	Polygonum	Smart weed	Polygonaceae

## Appendix II: Figures

## Free Floating Macrophytes



Figure 1: Lemna



Figure 2: Nymphoides

## Submerged Macrophytes



Figure 3: Utricularia



4: Ceratophyllum



Figure 5: Cabomba



Figure 6: Rotala



Figure 7: Najas



Figure 8: Limnophilla

**Rooted Submerged Macrophytes**



Figure 9: Hydrilla



Figure 10: Potamogeton

**Emergent Macrophytes**



Figure 11: Typha



Figure 12: Cyperus



Figure 13: Scirpus



Figure 14: Ipomoea



Figure 15: Alternanthera



Figure 16: Polygonum



## The General land Use Pattern in Perid Village: A Geographical Case Study

**Dr. Prakash Soudagar Raut**

Department of Geography  
Y. C. Warana Mahavidyalaya, Warananagar  
Tal- Panhala Dist. Kolhapur-416133

### 1.Introduction:

The classification of land according to its quality for a particular purpose is known as land Use. The concept of land classification is often used for agriculture as a whole to other use. Land capability classification is a scientific appraisal of the physical characteristics of land. "Land use is also related to conservation of land from one major use to another general use" (Nanavati) "Land use means surface utilization of all development and vacant land for a specific point at a given time and space" (Foreman T. W.) L. D. Stamp has classified the need of land into seven major categories viz. arable, heath and rough, pastures, orchards and nurseries, meadowland, forest and woodland and urban areas. The need of man work house, transportation, communication, defence and recreation. Land is necessary for human survival, because it provides man with living space, with food and number of raw material which are used in the satisfaction of his wants.

**2.Objective:** The main objective of the present research paper is a geographical study of general land use pattern in Perid Village

### 3. Study Region:

The Perid Village of Kolhapur district that lies in south-western part of Maharashtra, The average altitude of Perid Village is 550 meter. It extends between 16<sup>0</sup> 56' 2.86'' North latitudes and 73<sup>0</sup> 56' 30.07'' East longitudes. This having dry summer and moderately cool winter. Its total geographical area is 595.20 hectares and population according to 2011 census is 2500.

### 4.Research Methodology:

For the present research paper, researcher has adopted following method for data collection. The present research work is mainly based on primary source of data. The field study has been organized in the Study region. The collection of secondary data is done from various officers of Study region. The collected data has been represented in the forms of relevant cartographic techniques.

**General Land Use Pattern in Perid Village:** Table No. 1 reveals that the general land use pattern in Perid Village:

**Table No.1**

**General Land Use Pattern in Perid Village:**

Sr. No.	Land use Pattern	Area in Hectares	Percentage to total Geographical Area
1	Area under forest	101	16.96
2	Land not available for cultivation	12.2	2.01
3	Permanent pastures and trees and grow	39	6.55
4	Fallow Land	10	1.67
5	Net area sown	433	72.74
	<b>Total Geographical Area</b>	<b>595.2</b>	<b>100</b>

Source: - Field Study, 2015

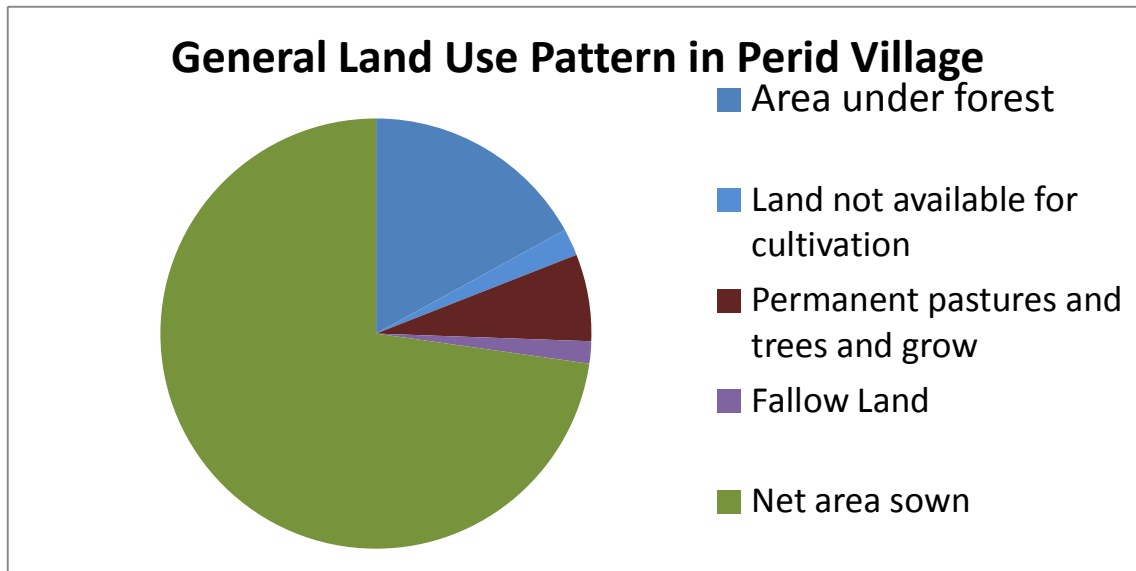

- **Area under Forest:**

This category includes any land classed or administered as a forest under legal enactment. The figures under grazing lands or a crop within the forest are also included in the area under forest. It is clear from the Table No.1 and Figure No. 1 that the total area under forest was 101 hectares. This was 16.96 per cent of the total geographical area in study region, being less than the average for Kolhapur district.

- **Land not Available for Cultivation:**

This category includes barren and uncultivable land and area under non – agricultural use. Barren and uncultivable lands are bare rocky outcrops of hills, plateaus, mountain etc. This land can under no conceivable circumstances be brought under cultivation but at a very high cost a very little proportion may be classed as uncultivable. Area under non – agricultural use covers all lands occupied by settlements, roads and railways, beds of streams, ponds and canals. General land use pattern under this category are exhibited in Table No.1 and Figure No.1 that is 12.2 hectares during 2015. Thus it was 4.95 per cent of the total geographical area of the Perid village.

- **Permanent Pastures and Trees and Grow:**

The permanent pastures and other grazing lands embrace all grazing lands which may be permanent meadows and village common pasture. Area under miscellaneous tree crops etc. covers all cultivable and which is not included in the net area sown, but is put to some agricultural use other than seasonal cropping. This is clear from that area under permanent pastures and trees and groves in study region was 12.2 hectares during 2015. Thus, it was 2.01 percent of the total geographical area of the study region.

- **Fallow Land:**

This category of land consists of current fallow and other fallow lands. Current fallow the lands left unsown during the current agricultural year only to regain fertility and also that which remained uncropped in the short – term for want of moisture and economic reasons. The fallow lands comprise all lands which were taken up for cultivation but are temporarily unsown for a period of not less one year and not more than seven years. The Table No.1 reveals that area under total fallow land in the study region. It was 10 hectares during 2015. Thus it was 1.67 percent of the total geographical area of the study region.

- **Net area sown:**

The net area sown represents the extent of the cultivated area actually sown during the year 2015. It may be referred to as net cropped area also. The Perid Village is one of the widely cultivated areas of the 433 hectares or 72.74 per cent of its total geographical area devoted to crop. Spatial distribution of

net area sown to a large extent is influenced by variation in relief. River valleys, Flood plains, low land and low under cultivation.

#### 4. Conclusion:

The total geographical area of the Perid Village is 595.20 hectares. In the Perid village the utilization of land use was classified into five categories i. e Forest land, Land not Available for Cultivation, Permanent pastures and trees and grow, Fallow Land and Net Area Sown. In the study region Net Area Sown is the most important type of land use and excels all the other land use categories. Proportion of such land is higher in 433 hectares or 72.74 percent of its total geographical area.

#### 5. References:

1. Colman, A. (1961): The Second land Use Survey: Progress and Prospect, Geographical Journal
2. Henderson, J.M.(1959): The Utilization of Agricultural Land: A Theoretical and Empirical Enquiry, Review of Economics and Statistics.
3. Stamp, L.D. (1948): The Land of Britain: its Use and Misuse, Longman, Green and co. London
4. Majid Husain (1999): Human Geography, Rawat Publications, New Delhi
5. Majid Husain (1997): Systematic Agricultural Geography, Prem Rawat for Rawat Publications, Jaipur
6. Er.Anil Jamwal (2010): Land Use and Resource Management Using GIS, Jnanada Prakashan, New Delhi.

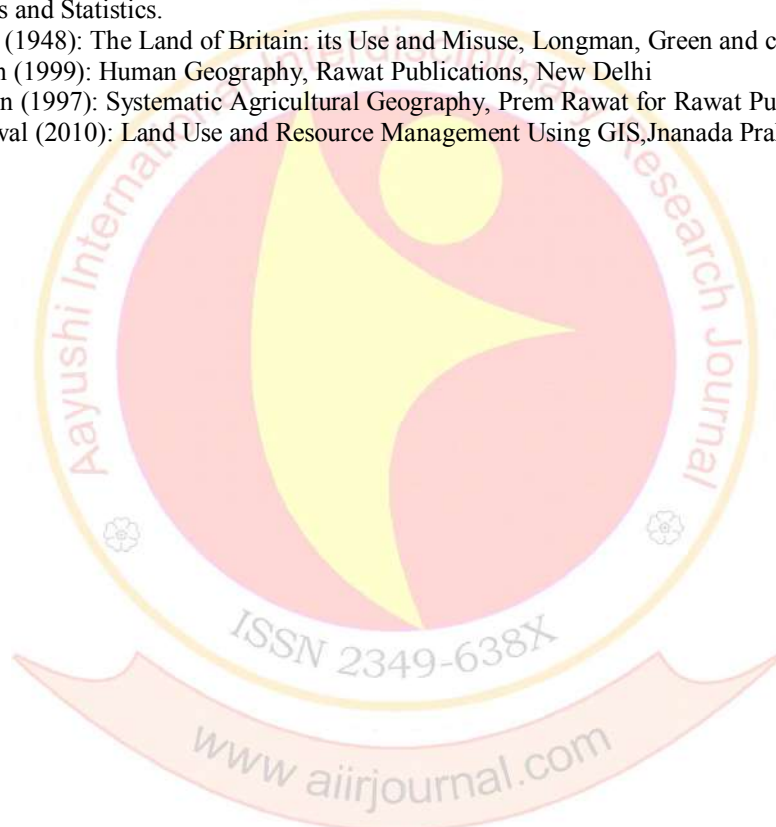

## Introduction to Wind Energy

**Dr. Tilekar Sharad Balasaheb,**

Head, Dept. of Geography,  
Shreemant Bhaiyyasaheb Rajemane College, Mhaswad,  
Tal- Man, Dist- Satara-415509.  
Affiliated to Shivaji University, Kolhapur.

### Abstract: -

*The present study focused on the importance of wind energy system. Today world face various disasters like floods, tsunamis, volcanic eruptions, fires, earthquakes, cyclones and landslides are natural hazards that kill lots of people and destroy energy every year. The rising concerns over global warming, environmental pollution, and energy security have increased interest in developing renewable and environment friendly energy sources such as wind, solar and hydropower. Around this wind energy can provide suitable solutions to the global climate change and energy crisis. All over the world tremendous growth in wind power has been seen during the recent decades. Wind energy promising renewable, clean, and reliable energy source. Wind power is highly expected to take a much higher portion in power generation in the coming decades. This paper concludes that the wind energy provides almost all energy needs and plays an important role in the world's energy market.*

**Key words:** - Wind energy, global warming,, energy crisis.

### 1. Introduction:-

Today the population of world recorded higher growth and developmental activities require lot of energy. Throughout world has so much natural and manmade disasters and occupying damage is almost possible. At the time of disasters the most of energy sources damaged. That had resulted to the energy crises. The world-wide demand for energy has been growing rapidly. The rising concerns over pollution, global warming and energy security have increased interest in developing environment friendly and renewable energy sources such as hydropower, nuclear, solar and wind energy. Wind energy can provide suitable solutions to the global climate change and energy crisis. The traditional coal-fuel power plants emissions CO<sub>2</sub>, SO<sub>2</sub>, and other harmful wastes as well as radioactive wastes by nuclear power plants. The traditional power plants pressured on the resources and resulted into the pollution and global warming. The world-wide demand for energy supply can be reduces the dependence on fossil fuels, price and supply instability by wind power energy. During the recent periods tremendous growth in wind power energy has been seen all over the world. Wind energy is renewable, clean, and reliable energy source. Due to this characteristics of wind energy highly expected to take a much higher portion in power generation in the upcoming decades.

### 2. Objective:-

The present study understands to the valuable importance of energy and necessity of clean, and reliable energy source like as wind power energy.

### 3. Data Base and Methodology:-

The present study is based secondary data. The Secondary data obtained from report of national institute of energy and different websites.

### 4. What is Energy:-

The word energy derives from the Ancient Greeak. Energy was a qualitative philosophical concept and ideas. Energy is the moving property that must be transferred to an object in order to perform work or heat. Earth receives energy from the sun and the geothermal energy contained within the earth. The process of climate and ecosystem are taken by the radiant energy. Human civilization requires energy to different functions. This receives from resources and fossil fuels and other renewable energy. In the other word energy is an attribute of an energy supply from different sources. However energy is also expressed in many ways such as calories and units. Some energy is transferred and reaction in the form of heat or light. Any living organism having an external source of energy, in the case of green plants energy from the sun, in case of animal and human being energy from form of chemical. In the simple word energy means the capacity of doing different type of work. It may be exit in various forms, e.g. potential, electrical, thermal, chemical, kinetic and nuclear and energy can be converted from one to another in various ways.

### 5. Types of Energy:-

The energy system can be classified into basic forms, e.g. potential energy and kinetic energy. The kinetic energy refers to the energy of moving objects, and the potential energy belongs to the energy which is stored. Around these categories the scientists includes the different types of energy like as radiant energy, thermal energy, nuclear energy, electrical energy, chemical energy, sound energy, motion energy, gravitational energy and elastic energy.



- A) **Thermal energy:-** The thermal energy is created from destroy of atoms of nuclear resources.
- B) **Radiant energy:-** This type of energy known as electromagnetic energy. e. g. energy from sun and radio waves.
- C) **Nuclear energy:-** Nuclear energy stored in nucleus atmos.
- D) **Electrical energy:-** Electrical energy is created from movement of protons and neutrons and move through wires.
- E) **Chemical energy:-** Chemical energy stored in molecules which is found in the food and biomass.
- F) **Sound energy:-** Sound energy is movements of sound force with vibrate.
- G) **Mechanical energy:-** Mechanical energy is stored in moving objects. e. g. wind, river water etc.
- H) **Gravitational energy:-** This type of energy is in high speed object moving into the lower position.

## 6. Wind Energy:-

Winds are great history in human civilization with his pressure. Winds are historically used to the traveling of bots. The wind energy is captured by wind. It is renewable energy and significant potential. The wind turbine is rotate in circle position with the pressure of wind speed and turn into the energy which captured call as wind energy. The region are located on the costs, island, mountains and water bodies have most potential to provide sufficient portion of wind energy. the wind energy is kinetic energy and promotes the need of electricity. The multiple turbines are being constructed in the multi megawatt range called as wind farms. In spite of these there are geographical limitations for wind energy project for sitting. The wind farms provide large scale energy with low costs comparative with traditional power plants run with oil and coal. The winds are the product of sun. The surface of the earth has heats unevenly by sun and turn into the creating high and low atmospheric pressure belts. This had made air flow from high pressure to low pressure called as wind. With the help of wind pressure wind turbines rotated at high speeds to drive electrical generators and these generators provided electricity.

## 7. Advantage of Wind Energy :-

The wind power energy offers many advantages. Wind energy is fuel free depending upon wind resources and mitigates the lower price as comparative to traditional energy sources. Wind energy is unlimited, free and renewable resources. The harvesting wind energy is a clean and non polluting way to generate and eco friendly than other burning of fossil fuels. Wind power does not emit any emission can led to air and water pollution because no fuel is burned in the wind energy. Wind power has more potential to generate large scale energy. Jobs have been created for the manufacture of wind turbines, the technician for installation and supporting services by wind power plant. all over discussion indicates that the wind farms are benefited to the rural economy.

## 8. Disadvantage of Wind Energy:-

The wind power energy offers little disadvantages. Wind power plants have costly at the time of constructing turbines and making blades. The technology immaturity are the another disadvantage of wind energy. The wind farms may be their negative effect on wildlife. Many birds have been killed by flying turbines. Some time the wind turbines generate noise pollution. These are the some disadvantage marked by wind energy.

## 9. Concluding Remark:-

This paper deals with general review on utilization wind energy. The wind farms may be increasing and created opportunities for a more consumption and rapid demand of electricity. Today by using wind power generation technology can be very efficiently and environmental friendly. Instead of some limitations like as, lack of capital, the weakness of transportation in remote area, difficulty in developing and understanding the technology and models, and necessary infrastructure. The importance of wind energy is more significant.

## 10. References:-

1. Allen p. (2008): 'Energy Information Administration', *Renewable Energy Annual*, Pp. 1-49.
2. El-Ali. A. & Moubayed, N. (2007): 'Comparison between solar and wind energy in Lebanon'.
3. Gipe P. (1995): 'Wind Energy Comes of Age' , John Wiley & Sons, *Windmill dreams*, <http://www.chin.org.cn/english>
4. Mishra N. J. (2012): 'Wind Power Generation and Wind Turbine Design' Rawat publication, Pp. 1-103.
5. Ramakrishnan R. (2010): 'Wind turbine facilities noise issues', published research paper. 5-9.
6. Siddiqi, A.H. & Khan S. (2011): 'Wind speed simulation using wavelets'. *American Journal of Applied Sciences*, pp. 557-564.
7. Wei Tong (2009): 'Fundamentals of wind energy'. Kollmorgen Corporation, Virginia, USA
8. Wind Web Tutorial (2007): 'The American Wind Association', <http://www.awea.org/faq/index.html>.
9. Worcester (2012): 'Energy Information Administration', *Green Pricing and Net Metering*, July 2008. Vol. 6.
10. [www.geogle.com](http://www.geogle.com) different websites.

**Study of rain water harvesting in Ray Nagar Kumbhari, Solapur, Maharashtra, India.****P D Mali<sup>1</sup>, K C Mujawar<sup>2</sup>**1. Head Department of Geology Walchand  
College of Arts and Science, Solapur2. Associate Professor Department of Civil  
Engineering, N.B. Navale Sinhgad College of  
Engineering, Kegaon, Solapur**Abstract**

Hydro-geological study plays a much larger role in groundwater studies because of its importance in characterizing the natural system, understanding contaminant migration and designing remediation programs. William Deutsch (1997). Hem (1989) used major ion composition of groundwater to classify groundwater into various types of cations and anions. The availability of water is extremely uneven both in space, time and depth. So will it be the case in groundwater now and in future. The uneven distribution of groundwater in an area is mainly attributed to highly heterogeneous lithology and variability of rainfall. Therefore, an integrated approach is mandatory to view multi-dimensional problems be set in a watershed. The resistivity survey was carried out for rock type identification. Wenner configuration was used during resistivity survey.

Rain water harvesting is a technique of collection and storage of rainwater into natural reservoirs or tanks, or the infiltration of surface water into subsurface aquifers (before it is lost as surface runoff). The harvesting of rainwater simply involves the collection of water from surfaces on which rain falls, and subsequently storing this water for later use. Normally water is collected from the roofs of buildings and stored in rainwater tanks. Rainwater harvesting is the accumulation and deposition of rainwater for reuse before it reaches the underground. Uses of this water include water for drinking, garden, water for livestock, etc. As a humble effort, yet benefitting to the present day requirement has been envisaged by the authors in this work. The present work gives the detailed study of the area in which vesicular and amygdaloidal igneous structures observed in basalt rock. Ground water is available in unconfined and confined aquifer. Pre monsoon water level is 8 to 11 meter below ground level. Post monsoon water level is 4 to 6 meter below ground level. Total number of recharge pit cum bore wells -10 nos. Dimension of recharge pit cum recharge bore well – 2m x 2m x 2m. Diameter of recharge bore wells = 180 mm and depth of Bore well – 30 meter. The paper deals with total rain water harvesting and its management.

**Keywords:** Hydrogeology, Rainwater harvesting, Electrical resistivity, Rain fall, Housing project

**Introduction**

Water plays a significant role in our lives since it is a precious natural resource. Over the past few years, there has been an increase of water shortages in several parts of the world. It is vital that ideal measures are put in place to help to reduce the high rate of water loss. With the change in climate patterns, people need to be aware of the alarming water shortage that we face currently and the imminent danger of severe shortage in the future. Various methods can be implemented to address the water problem in the most area. Rainwater harvesting is one of the methods that can be used for water conservation.

Rain water harvesting is a technique of collection and storage of rainwater into natural reservoirs or tanks, or the infiltration of surface water into subsurface aquifers (before it is lost as surface runoff). The harvesting of rainwater simply involves the collection of water from surfaces on which rain falls, and subsequently storing this water for later use. Normally water is collected from the roofs of buildings and stored in rainwater tanks. Rainwater harvesting is the accumulation and deposition of rainwater for reuse before it reaches the underground. Generally water collects from rooftops, the land surface or rock catchments using simple techniques such as containers and pots. Uses of this water include water for drinking, garden, water for livestock, etc. In many places the water collected is just redirected to a deep pit with percolation. Commonly used systems are constructed with three principal components; namely, the catchment area, the collection device, and the conveyance system. It is a technique or strategy for the collection of rainwater and storing it in the right way for future use. The water can be collected from various surfaces and platforms and stored for later use. In most cases, the water is usually collected from rooftops and other hard surfaces. Rainwater harvesting is considered as a very reliable way to conserve water.

**Study area**

The study area is Ray nagar federation housing society, Gat no. 728, A/P. Kumbhari, Tal. South Solapur. Dist- Solapur, Maharashtra. 413006 situated 14 km from Solapur city, Maharashtra. In forms parts of Survey of India topographic sheets 47 O/ 13, 47 O/14, 56 C/1 and 56 C/2. The area is bound by north latitudes 17° 42' and 17° 46' and east longitudes 75° 16' and 75° 56'. The annual rainfall is about 550mm to 650mm which is mainly received during the monsoon months of July to September. Groundwater occurrences in the area are controlled by the weathered and fractured part of the basaltic rock formation.

### Geology of the study area

Study area forms parts of the famous Deccan Traps, The lava assemblage in Solapur district belongs to Sahyadri Group and consists of Indrayani, Karla, Diveghat, Purandargarh and Mahabaleshwar formations. Each of these formation have "AA" and "Pa hoe hoe" lava flows and may consist of simple and compound flows and of the formation has more than couple of flow units. The flow units can be distinguished from one another on the basis of lithological character such as vesicularity, amygdaloidal, zeolites and compactness of the basalts. The top of the flow has been demarcated by vesicularity, flow breccias or red bole layer. The flow units have been laterally traced and correlated with the observations in the dug wells which are unlined. The lower most flow and the top most flow units are partial. This is because the base of the lower flow is not noticed and the top of the uppermost flow is not exposed in this region.

### Lithology of the area

#### Resistivity survey for rock identification

The resistivity survey was carried out for rock type identification. wenner configuration was used during resistivity survey. Wenner array consists of four collinear, equally spaced electrodes. The outer two electrodes are typically the current (source) electrodes and the inner two electrodes are the potential (receiver) electrodes. The array spacing expands about the array midpoint while maintaining an equivalent spacing between each electrode. The advantages of the Wenner array are that the apparent resistivity is easily calculated in the field and the instrument sensitivity is not as crucial as with other array geometries. Relatively small current magnitudes are needed to produce measurable potential differences. The disadvantages are that for each sounding, all of the electrodes have to be moved to a new position. In order to image deep into the earth, it is necessary to use longer current cables. The Wenner array is also very sensitive to near surface in homogeneities which may skew deeper electrical responses. Wenner electrode array geometry and apparent resistivity. (table 1, photo1)

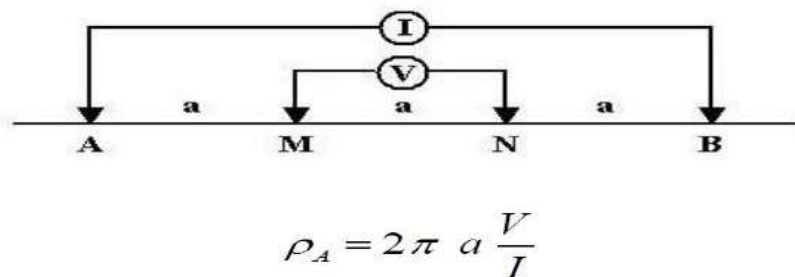

Fig.no.1: Shows wenner electrode array

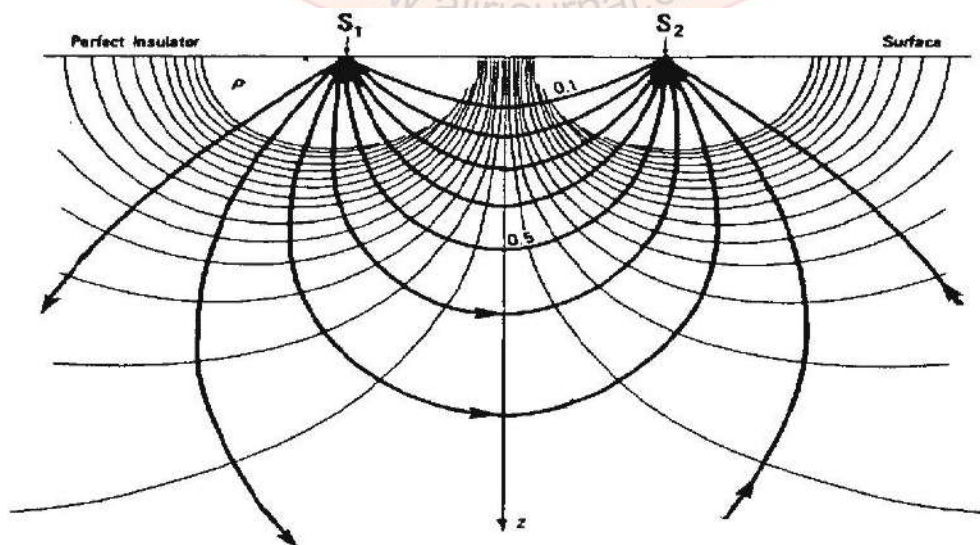

Fig. no. 2: Showing current flow lines



**Photo 1 : Shows resistivity survey for subsurface rock identification**

**Table no.1: Illustrates the rock types of the area**

Sr.no.	Depth in meters	Rock Types
1	0 - 5 mts	Soil and Weathered Basalt
2	5 - 30mts	Zeolitic Basalt
3	30 - 70mts	Tightly fractured Basalt
4	70 - 85mts	Red bole mixed zeolitic Basalt
5	85 - 95mts	Zeolitic Basalt
6	95 -100mts	Hard and Compact Basalt

### **Concept of rainwater harvesting**

Tapping the rainwater from where it falls – Techniques of rainwater harvesting involve Catch the rainwater from localized catchment surfaces such as roof of a house, plain and sloping ground surfaces etc. It is easy process to collect Rainwater and diverted into ponds, vessels or underground tanks to store for longer periods and to recharge by construction of RWH Structures in a suitable sites.

### **Advantage of Rain water harvesting**

#### **Reduces flooding and erosion**

Harvesting rainwater can help the environment in a number of ways. For starters, it can reduce erosion around downspouts and in gardens. It can also control storm water run-off. Rainwater doesn't produce scale and corrosion as hard water does. The collection of rainwater may reduce flooding in certain areas as well.

#### **Reduces water bill**

Rainwater harvesting will not only help individuals save on their water bills but can cut costs for entire communities. The cost to supply mains and overall water services can be substantially reduced when many people in one community use rainwater. Having a source of water can also reduce dependence on municipal sources in case the water becomes contaminated. Rainwater can be used as the primary source of water or as a backup source when needed.

#### **Can be used for non drinking purpose**

The majority of the water we need is used for non-drinking. Everything from washing clothes and dishes to bathing and flushing toilets require large amounts of water. Rainwater can be used for all of these things. Rainwater is soft and can lessen the need for detergents when washing clothes and dishes. Rainwater can also be used for washing vehicles, bathing pets, and nearly all cleaning that uses water.

#### **Improve plant growth**

Rainwater harvesting can also be used to improve plants and gardens. Using harvested water can flush the salt buildup from plants and soil. Harvested rainwater is generally free from several types of pollutants and man-made contaminants. Rain is also free from chlorination. Using water that is this clean and healthy for plants and trees can save money on overall property maintenance and landscaping needs.

While regular maintenance is required, simple collection systems can be constructed that most people can easily build and maintain. Rainwater harvesting and storage can be incorporated in both rural and urban areas and provides many benefits to individuals, communities, and the environment.

### Road water Harvesting:-

Road runoff water is often speeding down the drain, quickly concentrating into erosion gullies taking the soils along. Instead of giving it a speeding ticket, it can also redirect the water away from the road, within the adjacent area. Not letting it go, but also not letting it affect your road and landscape a new type of road water management. The concentrated water along roads and road catchment can be harvested. This harvesting can be done with simple structures on and along the road. Trenches, drains, cross-culverts, etc. A combination of techniques can channel water from roads into retention/infiltration areas. Benefits include groundwater recharge, landscape restoration, increased road infrastructure longevity, and increased water availability for agricultural and domestic use. Road water is to be recharged through trenches along the road

### Rain water availability

#### Total annual availability of rain water at site

Based on assuming annual rainfall is 550mm (from district HQ data Solapur)

However, annual rainwater sources are available on present study is as follow

**Table no. 2: Shows estimation of runoff before project completion**

Type of surface	Area sq. m	Runoff Coefficient	Average annual rainfall(m)	Annual potential for RWH(m <sup>3</sup> )
Non agriculture	50000	5.00	0.55	137500

**Table no. 2: Shows estimation of runoff after project completion**

Type of surface	Area sq. m	Runoff Coefficient	Average annual rainfall(m)	Annual potential for RWH(m <sup>3</sup> )
Roof top area	13894.98	1.39	0.55	10622.71

### Annual intake or absorbing capacity of aquifer

Based on assuming specific yield of aquifer in basaltic terrain 0.02 and resistivity data and hydrogeological data, water can be stored in the aquifer.

Area of aquifer x Thickness of aquifer (from resistivity data) x Specific yield of aquifer  
 $= 50000.m \times 25m \times 0.02 = 25000 \text{ m}^3$

The rainwater harvested from terrace will be recharged and stored in the aquifer the rest of water will be flow near to tributaries

Area of recharge x Thickness of aquifer x Specific yield of aquifer  
 $= 13894.98 \times 25m \times 0.02 = 6947.49 \text{ m}^3 \text{ per bore per year}$

### Water harvesting potential of the area:-

Area of catchment in 13894.98 sq.m x Amount of minimum rainfall 550 mm = 7642239 cu.m

### Influencing factor

Among the several factors that influence the rainwater harvesting potential of a site, eco-climatic conditions and the catchment characteristics are considered to be the most important.

### Catchment area characteristics

Runoff depends upon the area and type of the catchment over which it falls as well as surface features. All calculations relating to the performance of rainwater catchment systems involve the use of runoff coefficient to account for losses due to spillage, leakage, infiltration, catchment surface wetting and evaporation, which will all contribute to reducing the amount of runoff.

Catchment area characteristics Runoff depends upon the area and type of the catchment over which it falls as well as surface features. As mentioned earlier rainfall measured in depth and it is the point rainfall. In order to get the volume of water i.e. the rainwater endowment of that area we have to multiply the depth of the rainfall with the catchment area. For the Roof Top Rain Water Harvesting catchment area is the roof surface. The effective area of roof used for computing volume of water is called roof foot print. For plane horizontal rectangular or other shape roof, roof foot print is same as the roof and thus effective area is same.

## Results and Discussion

### Rainwater harvesting is in two ways

**A. Direct Use:** The process of collecting and storing the rainwater by construction of sump through filters for future productive use

**B. Artificial recharge to groundwater:** Recharge the rainwater in a scientifically planned way by construction of rain / roof top water harvesting structures to augment the groundwater. Groundwater aquifers can be recharged by various kinds of structures to ensure percolation of rainwater in the ground instead of draining away from the surface. We are adopting commonly used recharging methods

### Recharging Subsurface aquifers

Rain / Roof Top Water Harvesting: Water is essential for life and place a major role in earth's climate. By modifying land use, the proportion of the different pathways, evaporation, percolation and run off change.

The never ending exchange of water from the atmosphere to the oceans and back again is known Hydrological Cycle. In the present day world, rapid urbanization coupled with industrialization has become the order of the day. Added to urbanization, scanty and erratic rainfall is often resulting in reduction in water levels indicating depletion in storage in the surface reservoirs. Dependence on ground water is increasing rapidly over the past two decades. The demand is so high that indiscriminate use of groundwater resulting in steep fall of the ground water levels and there is also reduction in yields.

### Recharging of bore wells

#### Recharge pits with bore well:-

Rainwater collected from rooftop of the building is diverted through drain pipes to settlement or filtration tank. After settlement filtered water is diverted to bore wells to recharge deep aquifers. Abandoned bore wells can also be used for recharge. Optimum capacity of settlement tank/filtration tank designed on the basis of area of catchment, intensity of rainfall and recharge rate. While recharging, entry of floating matter and silt should be restricted because it may clog the recharge structure. First one or two shower should be flushed out through rain separator to avoid contamination.

Groundwater recharge or deep drainage or deep percolation is a hydrologic process where water moves downward from surface water to groundwater. Recharge is the primary method through which water enters an aquifer. This process usually occurs in the vadose zone below plant roots and is often expressed as a flux to the water table surface. Recharge occurs both naturally (through the water cycle) and through anthropogenic processes (i.e., "artificial groundwater recharge"), where rainwater and or reclaimed water is routed to the subsurface

### Conclusion

Water is essential for survival and has no substitute Demographic growth has led to the problems of water poverty and war for water. In the present investigation an attempt has been made to study the distribution of rain water for the benefit of proposed housing project. In the area of investigation rocks are not exposed on the surface of site. The bore wells in and around site are more than 60 meter deep most of bore

<b>Size of recharge pits</b>	2m Length X 2m Breadth X 2m Deep with 30m depth Borewell
------------------------------	--

wells around site are medium to low yielding in summer. The zeolitic basalt is a porous and permeable rock formation in site area and Vesicular and amygdaloidal igneous structures observed in basalt rock. Ground water is available in unconfined and confined aquifer. Pre monsoon water level is 8 to 11 meter below ground level. Post monsoon water level is 4 to 6 meter below ground level. Average annual roof top terrace rain water resources is = 10622.71 cu.m. Absorbing capacity of aquifer approximately = 25000 m<sup>3</sup> per year. Total number of recharge pit cum bore wells - 10 nos, dimension of recharge pit cum recharge bore well - 2m x 2m x 2m, diameter of recharge bore wells = 180 mm. Depth of Bore well - 30 meter and depth of perforated or slotted casing 6m. Not recommending water harvesting tank.

### References

1. Handa B.K., 1964: Modified classification procedure for rating irrigation water. *Soil science* 98, 264-269 pp
2. S.N. Kalia (2013) "Rainwater Harvesting – A Case Study Catch Water where it Falls", *Sustainable Water Resources Development and Management*, pp. 153-159
3. Ranjit Kumar Sharma, 'Rainwater Harvesting at N.I.T. Rourkela', Department Of Civil Engineering, National Institute of Technology, Rourkela 2010
4. Rain Water Harvesting, CAMTECH/2004/C/RWH/1.0, Ministry of Railways, Government of India, August 2004
5. S.N. Kalia (2013) "Rainwater Harvesting – A Case Study Catch Water where it Falls", *Sustainable Water Resources Development and Management*, pp. 153-159 iii.
6. Ranjit Kumar Sharma, Rainwater Harvesting at N.I.T. Rourkela, Department Of Civil Engineering, National Institute of Technology, Rourkela 2010 iv.
7. Rain Water Harvesting, CAMTECH/2004/C/RWH/1.0, Ministry of Railways, Government of India, August 2004 Data Collection from District Authority of Solapur District.
8. Mujawar K C, Gajul M D, Prabhakar P, Hydrogeological and Geophysical Investigations For Groundwater Resources In Sinhgad Institutes Campus, Solapur In the Proceedings of fourth International conference on Hydrology and watershed Management, ISBN code: 978-81-8424-952-1
9. Mujawar K C, Gajul M D, Prabhakar P, Assessment of groundwater quality in basaltic terrain of Shelgi nala watershed, Solapur, Maharashtra. *International Journal of Emerging Technology and Advanced Engineering*, Vol-05, pp 123-129

## Synthesis Of New 4-Substituted Amino Pyrido [2, 3-D] Pyrimidine Derivatives Under Solvent- Free Conditions

Nagargoje G.R. and Kedar N. A.

Department of Chemistry,  
Shivaji Mahavidyalaya, Renapur, Dist.  
Latur, (M.S), India-413527  
Department of Chemistry,  
Dayanand Science College Latur, (M.S),  
India-413512

### Abstract :

Many classes of chemotherapeutic agents containing pyrimidine derivatives are in clinical use such as antioxidants, antitumour, antimicrobials, antipyretic, antifungal, antibacterial, antihistamines, antihypersensitive. Several fused heterocyclic substituted pyrimidine have also been reported to possess a wide biological activities. A new and efficient synthesis of 4 substituted aminopyrido [2, 3-d] pyrimidine derivatives from 2- Aminopyridine via formamide formation by nucleophilic addition with primary amines under solvent - free condition is described in present paper.

**Keywords:** Pyrido [2, 3-d] pyrimidine, 2-Aminopyridine, formamide, solvent- free condition.

### Introduction:

Pyrido [2, 3-d] pyridine ring structure is one of the most interesting heterocyclic in drug design and its derivatives have various potential pharmacological activities various biological activities exhibited by pyrido [2, 3-d] pyrimidine are antitumor [1-3], antimicrobial [4-5] antipyretic [6], antifungal [7], antibacterial [8-10], antihistaminic [11] and antihypersensitive [12-13]. The pyridopyrimidine are an important class of annulated uracils with biological significance because of their connection with the purine, pyridine system [14]. Some pyrido[2,3-d]pyrimidine [fig A] were considered as inhibitors of dihydrofolate[15] or tyrosine kinase[16]. The synthesis of the pyrimidine ring required strict reaction condition, time consuming reaction and have low percent yield of produce [17-19].

Our ongoing development of efficient for the preparation of heterocyclic derivatives which are biologically active with versatility of organic synthon [20-22]. A New and efficient synthesis of 4- substituted aminopyrido [2, 3-d] pyrimidine derivatives from 2-aminopyridines via formamide formation by using primary amines under nucleophilic addition under solvent free conditions.

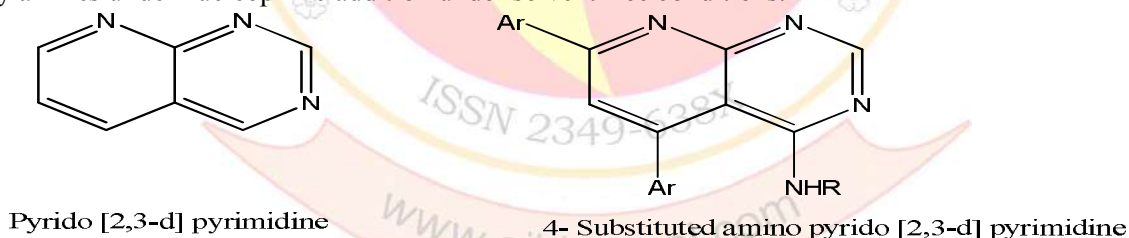

Fig.1 : Structure of pyrimidines

### Materials And Methods

All chemical were purchased from merck, SD-fine, qualigens and sigma-Aldrich. Solvent and Reagents were used without further purification, unless otherwise specified melting points were determined in an open capillary tube and are uncorrected. The TLC were visualized in an Iodine chamber.

### Experimental /Methodology:-

#### 1) Procedure for the synthesis of arylethylidenemalononitrile [2a-c]:-

A mixture of aromatic aldehyde [1a-c] (10 mmol) with malononitrile (10 mmol) taken in water was stirred at room temperature for 20-35 min. The white solid obtained which washed by using diethyl ether (50 ml) and recrystallized from absolute ethanol to give product 2a-c. compound 2a 2-(4- Chlorobenzylidene ) malonoitrile obtained according to the procedure using 1, using 1a (10 mmol ; 1.40 gm) and malonoitrile (10 mmol, 0.66 gm) as a white solid (1.80 gm, 96%) melting point is 163<sup>0</sup>C. <sup>1</sup>H NMR (CDCl<sub>3</sub>)  $\delta$ <sub>ppm</sub> : 7.43 (2H, d, J<sub>H-H</sub> = 8.4, H<sub>arom</sub>); 7.69 (2H, d, J<sub>H-H</sub> = 8.4 H<sub>arom</sub>), 7.83 (1H, s, C = C- H), <sup>13</sup>C NMR (CDCl<sub>3</sub>)  $\delta$ <sub>ppm</sub> : 158.23 (C=C); 141.33 (C<sub>arom</sub>); 133.82 (C<sub>arom</sub>); 130.13(2 x C<sub>arom</sub>); 129.37 (2 x C<sub>arom</sub>); 113.45 (CN); 112.30 (CN); 83.45 (C=C); IR (neat/ cm<sup>-1</sup>): 2226; 1585.

#### ii) General Procedure for the synthesis of 2- aminopyridine [4a-d]:-

A mixture of arylethylidenemalononitriles 2a-c (10 mmol), substituted acetophenones 3a-d(10mmol), and ammonium acetate(10mmol) was heated at 100<sup>0</sup> C for 4 hrs, then cool and poured into ice water 25ml to formed solid ppt and recrystallized from absolute ethanol to give the product 4a-d as white solid compound.

**2-amino-4-(4-chlorophenyl)-6 (phenylnicotinonitrile) [4b].**

This compound was prepared by the reaction of 2-(4- chlorobenzylidene) malononitrile (10 mmol; 1.88 gm), Acetophenone (10 mmol, 1.20 gm) and ammonium acetate (10 mmol; 0.77 gm) or ammonium carbonate (10 mmol; 0.96 gm) following the above general procedure 2. It was obtained white solid having yield (2.84 gm , 93%), melting point 222<sup>o</sup>C. <sup>1</sup>H NMR (CDCl<sub>3</sub>)  $\delta_{ppm}$  : 8.14 (2H, d, J= 8.4 Hz, H<sub>arom</sub>); 7.70 (2H ,d, J = 8.4 H<sub>arom</sub>), 7.48-7.50 (3H ,m, H<sub>arom</sub>); 7.23 (1H ,s, H<sub>pyri</sub>); 7.04 (2H ,d, J= 8.4 H<sub>arom</sub>); 6.99 (2H ,s, NH<sub>2</sub>); <sup>13</sup>C NMR (CDCl<sub>3</sub>)  $\delta_{ppm}$  : 164.3 (C-NH<sub>2</sub>); 158.9 (C=C-ph); 156.8 (C=C-CN); 134.9-128.41 (6xC<sub>arom</sub>); 128.3-124.55 (6xC<sub>arom</sub>); 116.3 (CN); 111.8 (C=C-ph); 85.5 (C=C-CN); IR (neat/ cm<sup>-1</sup>):3462; 2215; 1583; 1559.

**iii) General Procedure for the synthesis of N, N- dimethyl- N' (pyridin-2-yl) formamides [5a-d]:-**

A mixture of 4a-d (10 mmol) and of N, N- dimethyl formamide dimethyl acetal (10 mmol) was heated at 100<sup>o</sup> C for 3 hrs, then cooling the solid product formed filtered of and washed with absolute ethanol to give the product [5a-d] as white solid compound.

**(E) N'- (4- (4- Chlorophenyl)-3 cyano-6 phenylpyridin-2-yl)- N, N- dimethyl -1-formamide:-**

This compound was prepared by the reaction of 2-amino-4- (4- Chlorophenyl)-6- (phenylnicotinonitrile) (10 mmol; 3.35 gm) N, N-dimethyl formamide dimethyl acetal (10 mmol; 1.19 gm) following the above general procedure 3. It was obtained white solid having yield (3.28 gm , 91%), melting point 214<sup>o</sup>C. <sup>1</sup>H NMR (CDCl<sub>3</sub>)  $\delta_{ppm}$  : 8.62 (2H, s, H<sub>imine</sub>); 7.85 (2H ,d, J = 8.0 Hz, H<sub>arom</sub>), 7.40 (2H ,d, J = 8.0 Hz, H<sub>arom</sub>); 7.40 (2H ,d, J= 8.0 Hz, H<sub>arom</sub>); 7.25- 7.38 (5H ,m, H<sub>arom</sub>); 7.24 (1H ,s, H<sub>pyri</sub>); 3.02 (3H, s, NCH<sub>3</sub>); 2.99 (3H, s, NCH<sub>3</sub>); <sup>13</sup>C NMR (CDCl<sub>3</sub>)  $\delta_{ppm}$  : 164.3 (C-N $\equiv$ C); 158.52 (C=C-ph); 156.27 (C-N $\equiv$ C); 154.15 (C=C-CN); 138.41-129.79 (5xC<sub>arom</sub>); 129.09-127.36 (5xC<sub>arom</sub>); 116.62 (CN); 133.92 (C=C-ph); 89.29 (C=C-CN); 41.06 (NCH<sub>3</sub>); 35.08 (NCH<sub>3</sub>); IR (neat/ cm<sup>-1</sup>):3439; 2214; 1620; 1488.

**iv) General Procedure for the synthesis of 4-Substituted Amino pyrido[2, 3-d] Pyrimidine (6-9):-**

A mixture of 5a-d (10 mmol) and primary amine (10 mmol) was heated at 100<sup>o</sup> C for 4 hrs, then after completion of the reaction the residue was purified by using column chromatography over silica gel using a mixture of n-hexane- ethylacetate (5:5) as the eluent to give product 6-9.

**5- (4- chlorophenyl) -N- cyclohexyl -7- phenylpyrido [2,3-d] pyrimidin-4-amine:-**

This compound prepared by the reaction of (E)- N'- (4- (4- Chlorophenyl)-3 cyano-6 phenylpyridin-2-yl)- N, N- dimethyl -1-formamide (10 mmol ; 3.78 gm) and cyclohexylamine (10 mmol; 0.99 gm) following the above general procedure 4. The product formed was white solid having yield (2.72 gm , 66%), melting point 191<sup>o</sup>C. <sup>1</sup>H NMR (CDCl<sub>3</sub>)  $\delta_{ppm}$  : 8.11 (1H, s, H<sub>pyrimidine</sub>); 7.78 (2H ,m, H<sub>arom</sub>), 7.35 (2H ,d, J<sub>H-H</sub>= 8.0 Hz, H<sub>arom</sub>); 7.28- 730 (5H ,m, H<sub>arom</sub>); 7.05 (1H ,s, H<sub>pyri</sub>); 5.19 (1H, s, large NHH); 1.59 -1.62 (2H, m, -NH CH<sub>2</sub> CH<sub>2</sub> CH<sub>2</sub> CH<sub>2</sub> CH<sub>2</sub> CH<sub>2</sub>-); 1.232 -1.44 (4H, m, -NH CH<sub>2</sub> CH<sub>2</sub> CH<sub>2</sub> CH<sub>2</sub> CH<sub>2</sub> CH<sub>2</sub>-); 1.09 -1.28 (6H, m, -NH CH<sub>2</sub> CH<sub>2</sub> CH<sub>2</sub> CH<sub>2</sub> CH<sub>2</sub> CH<sub>2</sub>-); <sup>13</sup>C NMR (CDCl<sub>3</sub>)  $\delta_{ppm}$  : 160.24 (C-N=C); 160.06 (N=C-NH); 153.83 (C-N $\equiv$ C); 137.76 (C=C-ph); 136.13-116.93 (15xC<sub>arom</sub>); 110.9 (C=C-ph); 50.89 (CHNH-); 31.03 (CH<sub>2</sub>); 30.95(CH<sub>2</sub>); IR (neat/ cm<sup>-1</sup>):3496; 2215; 1620; 1495.

**Results And Discussion:-**

Synthesis of this pyrido [2,3-d]pyrimidine derivatives **6-9** is a multistep one (Scheme 1). The first step was based on the formation of 3-cyano-2-aminopyridine **4a-d** then, the second step involved the use of formamidines **5a-d** as key intermediates. Finally, pyrido [2,3-d] pyrimidine derivatives **6-9** are easily prepared by a cyclization reaction between compounds **5a-d** and various primary amines as nucleophilic agents under solvent-free conditions.

**Preparation of 3-cyano-2-aminopyridines 4a-d:**

Continuation of these researches for the synthesis of 2-aminopyridines and aiming to explore the potential of organic synthesis under solvent-free conditions (22-23), we have developed here an efficient method for the synthesis of 2-amino-3-cyanopyridines **4a-d** from arylythylenemalononitriles **2a-c** (Scheme A).

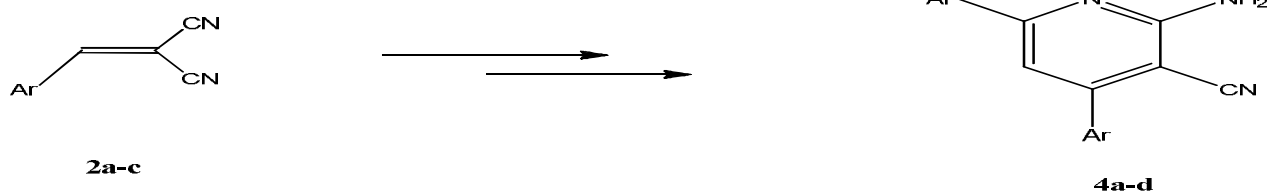
**Scheme A: Synthesis of 2-amino-3-cyanopyridines 4a-d**

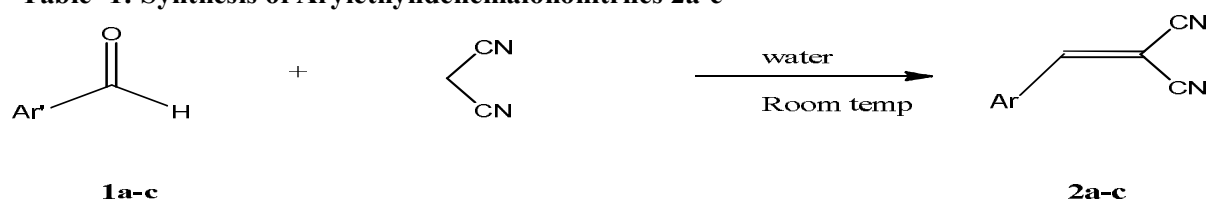
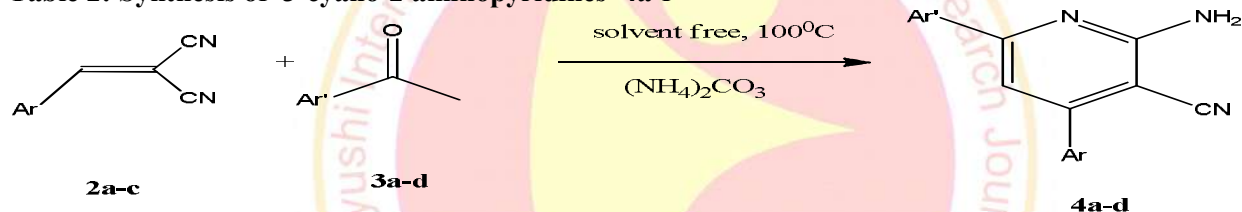

**Table- 1: Synthesis of Arylethylidenemalononitriles 2a-c**

Sr.No.	Ar	Product	Yield (%)
1	Ph	2a	85
2	4-ClC <sub>6</sub> H <sub>4</sub>	2b	96
3	4-BrC <sub>6</sub> H <sub>4</sub>	2c	90

**Synthesis of arylethylidenemalononitriles**

The reagent Arylethylidenemalononitriles are largely used as key product in organic syntheses, medicine, biology, and agriculture (24-25) Although arylethylidene-malononitriles have been extensively utilized as starting materials for the synthesis of a variety of polyfunctional heterocyclic compounds (26). The arylethylidenemalononitriles **2a-c** were prepared by the Knoevenagel condensation of substituted aromatic aldehydes **1a-c** with malononitrile in water at room temperature, they were obtained in good yields 85-96% (Table 1).

**Table 2: Synthesis of 3-cyano-2 aminopyridines 4a-f**

Sr.No.	Ar	Ar	Product	Yield (%)
1	Ph	Ph	4a	84
2	4-ClC <sub>6</sub> H <sub>4</sub>	Ph	4b	88
3	4-ClC <sub>6</sub> H <sub>4</sub>	3-MeOC <sub>6</sub> H <sub>4</sub>	4c	91
4	4-BrC <sub>6</sub> H <sub>4</sub>	2-MeOC <sub>6</sub> H <sub>4</sub>	4d	88

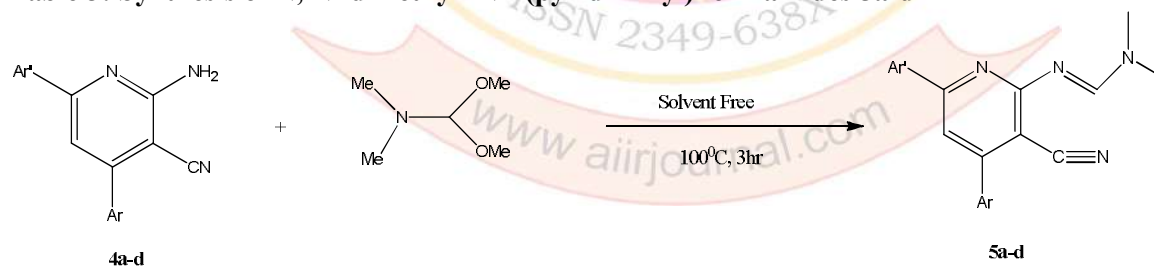
**Table 3: Synthesis of N, N- dimethyl- N'-(pyridin-2-yl) formamides 5a-d**

Sr.No.	Ar	Ar	Product	Yield (%)
1	Ph	Ph	5a	88
2	4-ClC <sub>6</sub> H <sub>4</sub>	Ph	5b	91
3	4-ClC <sub>6</sub> H <sub>4</sub>	3-MeOC <sub>6</sub> H <sub>4</sub>	5c	92
4	4-BrC <sub>6</sub> H <sub>4</sub>	2-MeOC <sub>6</sub> H <sub>4</sub>	5d	90

**Cyclization into 2-aminopyridine structures:**

3-cyano-2-aminopyridines **4a-d** were easily obtained, in cascade reaction from arylethylidenemalononitriles **2a-c** and substituted acetophenone **3a-d**. The reaction was carried out also under solvent free condition in the presence of ammonium acetate or ammonium carbonate to give yield 80-93% as shown in table 2.

Formamidine are very important intermediate for the synthesis of nitrogen heterocycles[ 28]. According to previous work in the chemistry of enamionitrile[27].we synthesized N,N, dimethyl-N'-(pyridine-2-yl)formamides **5a-f** under solvent free conditions which are prepared by the reaction of 2-aminopyridine **4a-d** derivatives with equimolar amount of dimethylacetal dimethyl-formamide. The mixture

was heated upto 3 hrs under solvent free condition to formed N,N-dimethyl-N'-(pyridine-2-yl)formamides **5a-d** to give excellent yield 88-92% as per table 3.

**Table 4: Synthesis of Pyrido[2,3-d]pyridine derivatives 6a-9b**

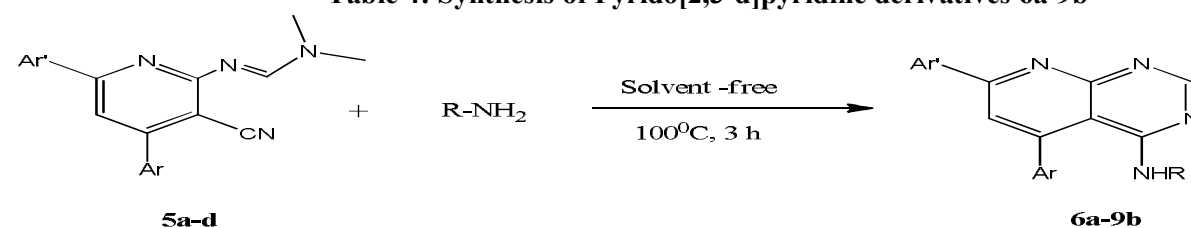

Sr.No.	formamidine	R	Product	Yield (%)
1	5a	Bn	6a	75
2	5a	Bu	6b	71
3	5a	Pr	6c	60
4	5a	Cy	6d	62
5	5b	Bn	7a	78
6	5b	Bu	7b	74
7	5b	Pr	7c	62
8	5b	Cy	7d	66
9	5c	Bn	8a	77
10	5c	Bu	8b	70
11	5c	Pr	8c	61
12	5c	Cy	8d	70
13	5a	Bn	9a	72
14	5a	Bu	9b	68

#### Synthesis of pyrido[2,3-d] Pyrimidine derivatives (6-9) :-

In order to study the reactivity of N,N-dimethyl-N'-(pyridine-2-yl)formamides **5a-d** which contains a cyano group in ortho positions, we have added various primary amines (benzylamine, butylamine, propylamine, cyclohexylamine) under solvent free conditions (Table 4). An equimolar mixture of precursors **5a-d** and different primary amines were heated during 3 hours to obtain compound **6-9** having good yields 60-78% which is described in Table 4.

For the formation of 4-substituted aminopyrido [2,3-d] pyrimidine **6-9** having proposed mechanism described as following way .

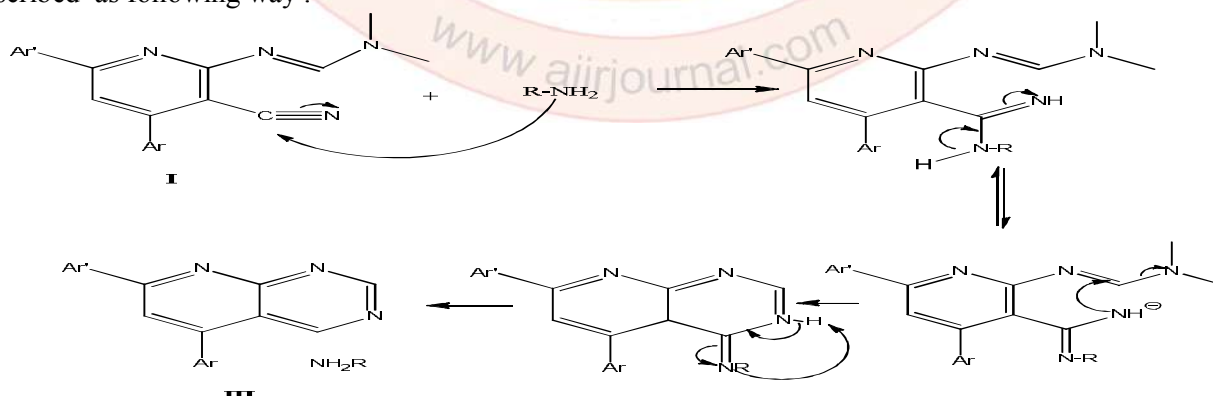

First intermediate **II** was obtained by the reaction between primary amines and cyano groups in ortho position of N,N-dimethyl-N'-(pyridine-2-yl) formamides **I**. Then an intramolecular cyclization between the imine anion and the double bond of the formamidine was realized and finally the 4- substituted aminopyrido[2,3-d] pyrimidine **III** were formed by an aromatization step under solvent free conditions.

#### Conclusion:

We have synthesized a new 4- substituted aminopyrido[2,3-d] pyrimidine derivatives from primary amine via formamidine under solvent free condition with high yield which have biological and pharmaceutical importance also make this procedure a useful addition to modern synthetic methods.

**References :**

1. (a) Gangjee A; Adair,O; Queener.S.F J. Med. Chem..1999,42, 2447-2455  
(b) Gangjee A; Adair,O; Queener.S.F J. Med. Chem..2003,46, 5074-5082.
2. Piper J.R., Mc Calab,G.S.;Montgomery J.A;Kishiuk R.K;Gamount Y;Sirotnak F.M. J. Med. Chem..1986,24, 382-389.
3. Sing G;Yadav A.K.;Mishraa K.,Indian J.Chem,2002,41,430-432
4. Reck; Alm R; Brassil P.;Newman J.; De Jonge B.;Eyermann C.J.;Breault G.;Comita- Prevoir J.; Cronin M.; Davis H.; Ehmann D.; Galullo V.; Geng B.; Grebe T.; Morningstar M.; Walkar P.; Hayter B.; Fisher,S. J. Med. Chem..2011,54, 7834-7847.
5. Gangjee A; Adair,O ;Queener.F.S Bioorg. Med. Chem..2001,11, 611-614.
6. Le Corre L.; Girard A. L. Aubertin J.; Radvanyi F.; Benosist-Iasselini C.; Jonquoy A. Mugniery E. Legeai-Mallet.; Busca P.; Lr Merrer Y. Org. Biomol. Chem.2010,8, 2164-2173.
7. Perner R J.; Lee C.H. jiang M.;Gu Y.G.; DidomenicoS.; Bayburt E.K.; Alexanders K.M.; Kohlhass K. Jarvis M.F.;Kowaluk E.L.; Bhagwat S.S Bioorg.Med.Chem. let. 2005,15,2803-2807.



## Biodegradation of Keratin by *Bacillus licheniformis*

R.A.Andhare

Dept. of Microbiology  
Shivneri Mahavidyalaya Shirur  
Anantpal Dist.-Latur

### Abstract:

Feathers constitute over 90% proteins, the main component are beta-keratin. It is degraded only by keratinase enzyme. These enzymes were produced by some species of *Bacillus*. In the present study *Bacillus licheniformis* was used for degradation of keratin and substrate used such as sheep, goat hair and feathers. Basal medium was prepared from this keratin substrate and the culture was inoculated and incubated. In this study we found almost 75 %Feathers were hydrolyzed by using microorganisms such as *Bacillus* and the remaining products can be used as animal feed. Hydrolysate produced after degradation found about 75% amount of protein and 20% carbohydrate. To our knowledge this process reduces the feed cost and produce industrially important enzyme and at the same time protect the environment from pollution.

**Key Words:** Feather, keratin, biodegradation, keratinase, *Bacillus*.

### Introduction:

Feathers are environmental wastes produced by poultry industries. The accumulation of some of these wastes in nature is considered to be a serious source of pollution and health hazards. Therefore, their proper disposal may be considered as a means of avoiding environmental pollution. Since feathers are almost pure insoluble fibrous keratin protein which is the primary substance found in chicken feathers, and cannot be degraded by common proteases (trypsin, pepsin, and papain). Feather wastes represent a potential alternative to more expensive dietary ingredients for animal feedstuffs. Generally, they become feather meal used as animal feed after undergoing physical and chemical treatments. Keratin is an insoluble protein macromolecule with very high stability and low degradation rate. Keratin is hard to degrade due to extensive disulphide bond and cross linkages. Resistance to proteolysis is due to cross linking of protein chains by cysteine bridges. Keratin is mainly present in hair, feather, nails, wool and horns. Feathers are generated in large quantities as a byproduct of poultry industry. Billions of chickens are killed annually and near about 8 billion tons of poultry feathers are produced.

Nowadays feather waste is utilized as a dietary supplement for conversion of feathers into food supplement can destroy amino acids and decrease protein quality. High protein content of keratin waste can be used as a good source of protein and amino acids by systemic recycling. Recycling of feather can provide a cheap and alternative protein feed stuff. Further this can be used for animal feed and for many other purposes. However, poor digestibility of keratin is a problem in recycling. In particular, feather from commercial poultry processing are produced in excess of million tons per year around the world. Feathers are currently converted to feather meal using steam and chemical treatments, but these methods destroy amino acid, and require significant energy input. Alternatively the use of keratinolytic microorganisms or keratinases has been investigated. Keratinase is an extracellular enzyme used for the biodegradation of keratin. Keratinases are enzymes that can hydrolyze both native and denatured keratin. Bacterial keratinase are of particular interest because of their action on insoluble keratin substrates, and generally on a broad range of protein substrates. Keratinase is produced only in the presence of keratin substrate. Keratinase attacks the disulfide bond of keratin to degrade it. Some microbes have been reported to produce keratinase in the presence of keratin substrate. Keratinase producing microorganisms have the ability to degrade chicken feather, hair, nails, wool etc. Keratinase belongs to class hydrolase. These are metalloproteins and efficient photolytic enzymes. This enzyme has been produced by bacteria *Bacillus licheniformis*. *B. licheniformis* is a gram positive, motile, spore forming, facultative anaerobe, and rod shaped organism. It is a nonpathogenic soil organism that is mainly associated with plant and plant materials in nature but can be isolated from nearly everywhere due to its highly resistant endospores that are disseminated with the dust.

### Review of literature:

Isolation, identification and characterization of feather degrading bacteria Samuel Pandian<sup>1</sup>, Jawahar Sundaram<sup>1</sup> and Prabakaran Panchatcharam<sup>2</sup> <sup>1</sup>Dept of Biotechnology, Bharath College of Science and Management, Thanjavur, Tamilnadu, India <sup>2</sup>PG and Research Department of Microbiology, PRIST University, Thanjavur, Tamilnadu, India. The present study deals with isolation, identification and characterization of feather degrading bacterium. The keratinolytic bacteria were isolated from feather dumped soil. The colonies showed higher keratinase production was identified as *Bacillus* sp, as per Bergey's manual method. Keratinase producing *Bacillus* sp, showed higher enzymes production. The crude filtrate showed specific activity of (>2.825) IU/mg and the protein of 4 mg/ml. *Bacillus* sp, produced keratinase at the pH 7 – 7.5 at the temperature of 40°C 2% feather meal as a substrate and incubation time of 96 hrs respectively which

indicated that the crude keratinase enzyme produced by *Bacillus* sp was classified as an alkaline protease. The protein profile of *Bacillus* sp was analyzed in SDS – PAGE. It showed that the presence of single band which corresponds to keratinase activity. FTIR Fourier Transform Infra-red Spectroscopy showed that the change in the functional group was catalyzed by unique enzymes of *Bacillus* sp. The keratin degrading gene sequence of isolated *Bacillus* sp, was analyzed further studies. Isolation, Identification and Characterization of a Feather Degrading Bacterium Savitha G. Joshi, M.M. Tejashwini, N. Revati, R. Sridevi and D. Roma Department of Biotechnology, B.V.B. College of Engineering and Technology, Vidyanagar, Hubli-31, Karnataka, India Feather constitutes over 90% protein, the main component being beta-keratin, a fibrous and insoluble structural protein extensively cross linked by disulfide bonds. This renders them resistant to digestion by animal, insects and proteases leading to serious disposal problems. In addition to this, feather waste is produced at the rate of 22 million kg per year (US alone). Use of keratinolytic microorganisms for feather degradation is an economic, environmental friendly alternative. Keratinases which are produced by these ten keratinolytic organisms could be used to degrade feather waste and further the digested products could be an excellent material for producing animal feed, fertilizers or natural gas. A feather-degrading bacterium was isolated from poultry waste. This bacterium was grown in basal media with feathers as its primary source of carbon, nitrogen, sulfur and energy. The organism is rod shaped, highly motile, endospore forming, catalase positive and gram negative. Phenotypic characterization carried out in our laboratory showed that this novel gram negative bacterium belongs to *Bacillus* genus. The organism is designated as *Bacillus* and named as *Bacillus* sp PW-1. The isolated strain has activity of 50 U/ml. This novel keratinolytic isolate could be a potential candidate for degradation and utilization of feather keratin.

Keratinolytic activity of *Bacillus licheniformis*, a feather-degrading bacterium the aim of this study was to investigate environmental conditions affecting chicken feather degradation and keratinolytic enzyme production by *Bacillus licheniformis*, a feather-degrading bacterium. *B. licheniformis* degraded whole chicken feather completely within 7 days. The bacterium grew with an optimum at pH 7.0–11.0 and 25–40 °C, where maximum keratinolytic activity was also observed. The production of keratinolytic enzyme by *B. licheniformis* was inducible with feather. Keratinolytic enzyme production by *B. licheniformis* at 0.6% (w/v) skim milk was 468U/ml, which was about 9.4- fold higher than that without skim milk. The amount of keratinolytic enzyme production depended on feather concentrations. The degradation rate of autoclaved chicken feathers by cell-free cultures supernatant was 26% after 24h of incubation, but the degradation of untreated chicken feathers was unsuccessful. *B. licheniformis* effectively degraded feather meal, duck feather and human nail, whereas human hair and sheep wool showed relatively low degradation rates. *B. licheniformis* presented high keratinolytic activity and was very effective in feather degradation, providing potential use for biotechnological processes of keratin hydrolysis.

#### Materials and methods:

1. Sample collection: - Feather dumping soils were collected from poultry farm. Collected soil sample was brought to the laboratory and used for the isolation of microorganisms. Soil sample was weighed and kept in the closed chamber in the moist atmosphere at room temperature.
2. Isolation of keratin synthesizing bacteria: - Serially diluted soil from poultry waste was taken for isolation of potent keratin degrading organism.
3. Screening of isolated species:
  - i. Morphological characteristics: Isolated species are characterized by using morphological characteristics like Size, Shape, Color, Margin, Surface, Elevation, Opacity, and Consistency.
  - ii. Gram's staining was done.
4. Screening on Skim milk agar plate  
Morphologically different colonies were identified and further inoculated on sterile skim milk agar plates and incubated at 37°C for 48 hours. The strains showing zone of clearance were selected as keratinolytic. Furthermore, the bacterial strains were inoculated in modified broth medium containing feathers and all the flasks were incubated at 130 rpm. Feather degradation was confirmed visually. The efficient bacterial strains showing degradation were identified by morphological, staining and biochemical tests.
5. Characterization of the isolates using Biochemical test i.e. IMViC test  
To check the feather degradation ability of isolates:

Feather hydrolysis was evaluated by a visual comparison of turbidity of experimental samples with the standard. The scale of turbidity was created using 5 test tubes to prepare feather suspensions with concentrations of 5% in 0.1 % phosphate buffer (pH 7.0)

Five test tubes each containing 10ml of 5% feathers suspension in 0.1% phosphate buffer (pH 7.0) were mixed with 100 ml of the culture broth. Incubation at 30°C continued kept in rotary shaker at 150 rpm.

Table.1:-Morphological characters of isolated species

Sr.no.	Characters	IS-1	IS-2	IS-3	IS-4
1	Size	0.7 cm	0.5cm	0.6cm	0.5cm
2	Shape	Rounded	Rounded	Rounded	Rounded
3	Color	Creamish	Creamish	Creamish	Creamish
4	Margin	Entire	Entire	Entire	Entire
5	Surface	Smooth	Smooth	Smooth	Smooth
6	Elevation	Flat	Flat	Flat	Flat
7	Opacity	opaque	Opaque	Opaque	Opaque
8	Consistency	Non-steaky	Non-steaky	Non-steaky	Non-steaky

**Result:**

It was found that a previously enriched, feather-degrading culture contained microorganism exhibiting keratinolytic activity. The isolate was a rod shaped bacterium which appeared singly and in chains. It displayed clearing zone when streaked onto the skim milk agar plates. The isolate were grown on basal feather agar and transferred at frequent intervals to the basal medium, containing finely chopped feathers. Microscopic observation of the isolate showed a straight rod with endospores. The bacterium grew aerobically, strongly catalase positive, Gram negative and was highly motile. Additional morphological, staining and biochemical tests were conducted.

Feathers are composed of beta keratin protein. A *Bacillus* strain *Bacillus licheniformis* has been isolated from feather dumping site and used for evaluating the keratin substrate as a source of amino acids along with the production of alkaline protease. Fermentation using feather as a substrate was carried out on minimal salt media for 7 days which resulted in almost complete degradation of feather.

Animal feed typically includes a carbohydrate source and a protein source. Common protein sources used in meal are expensive. These treatments also tend to destroy some amino acids, which are heat-sensitive amino acids. This lowers the quality of the protein in the feed. Due to these problems, feather meal is not extensively used in feed, despite the expense of other sources of dietary protein. It is reported that keratinolytic bacteria can degrade feathers.

**Conclusion:**

A feather-degrading bacterium was isolated from poultry waste. This bacterium was grown in basal media with feathers as its primary source of carbon, nitrogen, sulfur and energy. The organism is rod shaped, highly motile, endospore forming catalase positive and gram negative. Phenotypic characterization carried out in our laboratory showed that this novel gram negative bacteria belongs to *Bacillus* genus. The organism is designated as *Bacillus* and named as *Bacillus licheniformis*. Further analysis and confirmations will prove that the strain isolated by us, *bacillus licheniformis* can go a long way in tackling the problem of feather dumping in a useful way. If this strategy is carried forward effectively the waste can be used in a meaningful way. This study is, therefore, very important as it possesses the dual benefit of effective utilization of bio-organic waste materials from the environment and for the introduction the industrial production of keratinase. The *bacillus licheniformis* grew well in minimal salt media containing feather as only carbon source and degraded 75% of feather in a period of 21 days.

**References:**

1. Lin, X., Lee, C.G., Castle, E.S., Shih, J.C.H.,1992 Purification and characterization of a keratinase from a feather-degrading *Bacillus licheniformis* strain. *Appl. Environ. Microbiol.* 58(10):3271-3275.
2. Kim, J.M., Lim, W.J., Suh, H. J. 2001. Feather-degrading *Bacillus* species from poultry waste. *Process Biochem.* 37:287-291.
3. Williams, C.M., Richter, C.S., Mackenzie, J. m., Shih, J.C.H. 1990. Isolation, identification, and characterization of feather-degrading bacterium. *Appl. Environl. Microbiol.*56:509-1515.
4. Cheng, S.W., H.M. Hu, S.W. Shen, H.Takagi, M. Asano, and Y.C. Tsai. Production and characterization of keratinase of a feather degrading *Bacilluslicheniformis*PWD-1. *Biosci. Biotechnol. Biochem.* 59: 2239-2243, (1995).
5. Agrahari S. and Wadhwa N. Degradation of chicken feather a poultry waste product by keratinolytic bacteria isolated from dumping site at Ghazipur poultry processing plant, *Int. J. Poult. Sci.* 9(5), 482-489, (2010).
6. Lin H.H. and Yin L.J. Feather meal and rice husk enhanced keratinase production by *Bacillus licheniformis*YJ4 and characterization of produced keratinases, *J. Mar. Sci. Technol*, 18(3), 458-465, (2010).
7. Kim, J.M., Lim, W.J. and Suh, H.J. Feather degrading *Bacillus* sp., from poultry waste. *Process Biochemistry*, 37: 287-291, (2001)

## Use of Medicinal Plants on Antibiotic Resistant *Bacillus cereus* Isolated from Cooked Rice in Latur City

R. N. Jadhav

Shivneri Mahavidyalaya, Shirur (A).MS,India.

### Abstract

*Bacillus cereus* causes a short incubation type of food poisoning manifested by acute nausea and vomiting after the meal. Numerous surveys on food and ingredients have indicated a high percentage of samples containing *B. cereus*. Reports of outbreaks of *B. cereus* food gastroenteritis are quite uncommon in United States, however many European countries report frequent implication of this organism in food born illness. *B. cereus* food poisoning is associated most often with consumption of fried or boiled rice but it has been linked to other foods as well as such as mashed potatoes and spaghetti. Two syndromes diarrheal and emetic are recognized. Cooked rice samples were collected from different hotels and fast food centers in different locations of Latur city. From this Isolates of *B. cereus* were isolated & discussed in this paper. Isolates of *B. cereus* were identified depending upon morphological, cultural characteristics & biochemical tests. Antibiotic susceptibility testing was done by Kirby Bauer's disc diffusion method in accordance with the guidelines of the clinical & laboratory standards institute. Interpretation of resistance was based on the NCCLS criteria. The most common pattern of multiple drug resistance of isolates of *B. cereus* observed was Amoxycillin- Penicillin G- Rifampicin- Streptomycin- Cefepime- Oxacillin. Antibacterial activity of *Allium sativum*, *Syzyium aromaticum* and *Zingiber officinale* was studied against antibiotic resistant isolates of *B. cereus* by Agar well diffusion method. Aqueous extract of *A. sativum* showed moderate antibacterial activity while least antibacterial activity by ginger and clove. Solvent extract of plant showed enhanced antibacterial activity. It was also observed that antibacterial activity increases with the increase in concentration of plant extract.

**Key words:** Agar well diffusion assay; Antibacterial activity; Antibiotic resistant; *Bacillus cereus*; Disc diffusion method and plant extract.

### Introduction

*Bacillus cereus* is Gram positive, motile, spore forming, rod shaped bacteria. It is widely distributed in the nature and may be isolated from soil, vegetables, milk, cereals, spices, meat and poultry [1]. Reports of outbreaks of *B. cereus* food gastroenteritis are quite uncommon in United States, however many European countries report frequent implication of this organism in food born illness. Numerous surveys on food and ingredients have indicated a high percentage of samples containing *B. cereus*. *B. cereus* food poisoning is associated most often with consumption of fried or boiled rice but it has been linked to other foods as well as such as mashed potatoes and spaghetti [18]. Sufficient amount of viable cells of *B. cereus* must be ingested to develop signs and symptoms of syndrome. Two syndromes diarrheal and emetic are recognized [10]. Rice associated emetic illness is caused by serotypes 1, 3 or 5. Emetic toxin was produced only when *B. cereus* was grown in rice but not in other media. The illness is characterized by acute nausea and vomiting 1-5 hours after the meal [1].

Medicinal plants are the rich source of antimicrobial agents. They are used in many parts of world as a source of potent and powerful drugs to treat several diseases. Different parts of the medicinal plants are used for extracts as raw drugs and they possess varied medicinal properties. The bioactive compound of medicinal plants are screened and traded in market as raw material for many herbal industries [20, 22]. According to WHO medicinal plants are the best source to obtain variety of drugs. About 80% of individual from the developed countries use traditional medicine which contains compound from medicinal plants. Day by day the demand of herbal drugs is increasing throughout the world [9]. Inappropriate use of drugs has led to an increase in drug resistance in the microorganisms. Bacteria become resistant to antibiotic by different ways [2, 18]. Drug resistant bacteria in food threaten the efficacy of human drugs if antimicrobial resistance gene becomes incorporated into human bacterial population [21]. The problem of drug resistance could be overcome by herbal drugs. In the present work an attempt was made to isolate antibiotic resistant isolates of *B. cereus* from cooked rice samples from different hotels and fast food centers in Latur city & to study the effect of plant extract on it.

### Materials and Methods

#### Collection of cooked rice samples

Cooked rice samples were collected from different hotels and fast food centers in different locations of Latur city in polypropylene bags and brought to laboratory & stored at low temperature until analysis.

#### Isolation & identification of isolates of *B. cereus*

Isolation of *B. cereus* from cooked rice sample was done. Diluted food was spreaded on nutrient agar, MYPA media plates. Plates were incubated at 32 °C for 24-48 hrs. Isolates of *B. cereus* were identified by morphological, cultural properties & biochemical tests [1, 3 and 14].

### Study of antibiotic resistant pattern

Antibiotic susceptibility testing was carried out by Kirby-Bauer's disk diffusion method [3, 5] for drug susceptibility according to National Committee for Clinical Laboratory standards [16]. The Muller Hinton agar plates were spread with isolates of *B. cereus*. Antibiotic discs were put on the agar under aseptic condition. Plates were kept at low temperature in the freeze for short time for proper diffusion and then incubated at 37 °C for 24 hrs. Antibiotics used in this work were Amoxycillin (10µg); Cefepime (30µg); Chloramphenicol (30µg); Erythromycin (15µg); Ofloxacin (5µg); Oxacillin(1µg); Penicillin G (10U); Rifampicin (5µg); Streptomycin (10µg) and Tetracycline(30µg) supplied by Hi-Media Laboratories, Mumbai.

### Preparation of Plant extract

Good quality of bud of clove, bulb of garlic and fresh rhizome of ginger were collected from the local market and cleaned. Plant materials were crushed and mixed with sterile distilled water. Aqueous as well as solvent extract (ethanol and methanol) of these plant material were prepared separately. The obtained solvent extract was subjected to rotary evaporator and then subsequently concentrated and stored in refrigerator at 4 °C & tested by using Agar well diffusion method [4, 13].

### Antibacterial testing by Agar Diffusion Method

0.1 ml suspension of isolates of *B. cereus* was thoroughly mixed with sterile nutrient agar (molten) and poured into sterile Petri plates under aseptic condition. After cooling, plates were used for making of well by using sterile cork borer. Single plant extract was added in each well. Plates were kept at low temperature for proper diffusion and incubated at 37 °C for 1 to 2 days. Diameter of zones of inhibition was measured & noted [3, 13 and 17].

### Result and Discussion

Cooked rice samples were collected from different hotels and fast food centers in Latur city & from this isolates of *B. cereus* were isolated and identified on the basis of morphological, cultural & biochemical characters. On nutrient agar isolates of *B. cereus* produce grey white colonies with 3-5 mm in diameter. Isolates of *B. cereus* were Gram-positive, motile, spore forming bacteria. They were lecithinase +ve, DNase -ve, hemolysis on blood agar -ve, growth on mannitol salt agar -ve, catalase +ve, caseinase +ve, urease -ve, gelatinase +ve, starch hydrolysis +ve, Growth at 7% NaCl +ve, oxidase -ve, MR -ve, VP +ve, citrate -ve Indole -ve, glucose +ve, xylose -ve and arabinose -ve. 10 randomly selected isolates of *B. cereus* showed antibiotic resistance to at least one or more antibiotic. The most common pattern of multiple drug resistance patterns of isolates of *B. cereus* observed was Amoxycillin- Penicillin G- Rifampicin- Streptomycin- Cefepime- Oxacillin. The MAR index of each isolate was calculated by following formula:  
MAR Index = no of antibiotics to which the isolate was resistant ÷ Total no. of antibiotics tested

**Table 1 Percent resistance of *Bacillus cereus* isolates against individual antibiotic.**

Name of Antibiotics	No of isolate showing resistance	Percent resistance
Amoxycillin (10µg)	08	80
Cefepime (30µg)	02	20
Chloramphenicol (30µg)	00	00
Erythromycin (15µg)	00	00
Ofloxacin (5µg)	00	00
Oxacillin(1µg)	01	10
Penicillin G (10U)	06	60
Rifampicin (5µg)	06	60
Streptomycin (10µg)	05	50
Tetracycline(30µg)	00	00

The antibacterial activity of plant extract on isolates of *B. cereus* was studied, zone of diameter were measured & noted in the Table 2.

**Table 2: Antibacterial activity of plant extract on isolates of *Bacillus cereus***

Isolate of <i>Bacillus cereus</i>	Zone Diameter ( mm)		
	Clove	Garlic	Ginger
IBC01	12	-	13
IBC02	-	17	14
IBC03	-	24	16
IBC04	11	22	-



IBC05	--	-	14
IBC06	13	18	10
IBC07	-	17	-
IBC08	14	14	17
IBC09	10	20	-
IBC10	-	19	13

(--: no antibacterial activity)

Antibacterial activity of *Allium sativum*, *Syzium aromaticum* and *Zingiber officinale* was studied against antibiotic resistant isolates of *B. cereus* by Agar well diffusion method. Aqueous extract of *A. sativum* showed moderate antibacterial activity while least antibacterial activity showed by ginger and clove. Solvent extract of plant showed enhanced antibacterial activity. It was also observed that antibacterial activity increases with the increase in concentration of plant extract. Antibacterial activity of garlic is due to Allicin (allyl-2-propane thiosulfinate), a notable flavonoid in garlic, is formed when garlic cloves are crushed [6,7,19]. Garlic also contains sulphur-containing compounds such as allin, ajoene, diallylsulphide, dithin, S-allylcysteine, enzymes as well as vitamin B, proteins, minerals, saponin and flavonoids [24]. The antimicrobial activity of clove is attributable to eugenol, oleic acids and lipids found in it. It has antibacterial & antifungal activity [11]. Ginger contains besides some monoterpenes, the sesquiterpene-gingerol alcohol- gingerol. Gingerol is very pungent, yellow, a mixture of alcohol. Ginger has antimicrobial activity and thus can be used for the treatment of bacterial infections [23]. As garlic, clove and sativum showed antibacterial activity, it may be used to control food borne illness caused by *B. cereus*.

## References

- [1] Ananthanarayan and Paniker (2014). Text book of Microbiology 9th edition, University Press (India) Pvt Ltd, Hyderabad. [26]:249-250.
- [2] Anderson J.D (1968). The Ecology of transferable drug resistance in Enterobacteria, Ann. Rev. Microbiol. 22:131-180.
- [3] Aneja K.R (2007). Experiments in Microbiology, Plant Pathology & Biochemistry. New age international (P) limited.
- [4] Arora DS and Kaur J (1999). Antimicrobial activity of spices, Int. J. Antimicrob agents. 12: 257-262.
- [5] Bauer A.W., Kirby W.M. and Sherris J.C (1966). Am. J. Clin. Pathol. 45:493.
- [6] Cavallito CJ, Bailey JH, Allicin B J (1945). The antibacterial principle of *Allium sativum*. Its precursor and essential oil of Garlic. J Am Chem Soc. 67:1032-3
- [7] Corzo Martinez M, Corzo N and Villamiel M (2007). Biological Properties of Onion and Garlic. Trends Food Sci Technol. 18:609-625.
- [8] Dubey R.C and Maheshwari D.K (2009). A Text book of Microbiology. S. Chand & Company Ltd, New Delhi.
- [9] Ellof J N (1998). J. Ethnopharmacol 60:1-6
- [10] Fraziee W.C. and Westhoff D. C (2012). Food Microbiology. 431.
- [11] Hammer K A, Carson C F and Riley T Y (1999). The antimicrobial activity of essential oils and other plant extract. J Appl Microbiol. 86:985-990.
- [12] Jabar MA, Al-Mossawi A (2007). Susceptibility of some multiple resistant bacteria to garlic extract, Afr. J. Biotechnol. 6: 771-776.
- [13]. Jager A.K., Hutching A. and Van Staden (1996). J. Screening of Zulu medicinal Plants for Prostaglandin synthesis inhibitors, J. Ethnopharmacol. 52(2) 95-100.
- [14] Krieg N.R., Holt J.C. and Sneath P.H.A (1994). Bergey's manual of determinative bacteriology. 9th edition Williams & Wilkins. Baltimore, MD, USA.
- [15] Nadkarni K.M [1976]. *Z. officinale* In Indian Materia Medica, Popular Prakashan, Bombay. 1308-1335.
- [16] NCCL (1993). Performance Standards for Antimicrobial Disc Susceptibility Test Approved Standards. NCCLS Publication, M2-A5, Villanova, P.A, USA.
- [17]. Parekh J and Sumita Chanda (2007). Antimicrobial activity and Phytochemical analysis of some Indian medicinal plants, Turk J. Biol. 31:53-58.
- [18]. Pelzar Michael J., Chain, ECS and Krieg Novel R (2010). Microbiology, An application based approach. 335, 681.
- [19] Ross Z M, Moslin D J and Hill DJ (2000). The effect of steam distilled Garlic oil on lactic acid and other Enteric bacteria. 4th Symposium on European Microbiological Societies. FEMS Microbiol Rev 12:137.
- [20] Renisheya J J, Malar Johnson M, Mary U M and Arthy A (2011). Antibacterial activities of ethanolic extracts of selected medicinal plants against human pathogen. Asian Pac J Trop Biomed S76-S78.
- [21] Smith DL, Harris AD, Johnson JA, Silbegeld and Morris JG Jr (2002). Animal antibiotic use has early but important impact on the emergence of antibiotic resistance in human commensal bacteria, Proc Nat Acad Sc USA. 99:6434-39.
- [22] Srivastava J, Lambert and V. Vietmeyer (2006). Medicinal plants: An expanding role in Development. World Bank Technical Paper no. 320.

## Physicochemical Analysis of Agricultural Soil Quality Parameters in Patan Tahasil, State- Maharashtra

**Rajmati Patil ,**  
Asst.Professor ,  
PG Department of Chemistry ,PATAN ,Dist.SATARA  
\*Author for correspondence

### Abstract

*Use of increasing amounts of fertilizers and pesticides by some unconscious farmers cause soil pollution and soil infertility for the crop production. Usage of water in excessive amounts and/or in poor quality for irrigation creates problems during the plant production. In this present work agricultural soil samples were collected from different villages of patan Tahasil. Sampling and analysis were done by using standard techniques. Soil quality parameters such as pH, conductance, alkalinity, salinity(chloride), organic carbon, nitrogen, available phosphorus, water holding capacity were determined and results were compared with standard units.*

**Key words:** Agricultural soil, Soil quality parameters, Standard methods.

### 1 Introduction

Soil is a natural body consisting of layers (soil horizons) of mineral constituents of variable thicknesses, which differ from the parent materials in their morphological, physical chemical and mineralogical characteristics. It is mixture of mineral and organic constituents that are in solid, gaseous and aqueous states and study of it is important. [1]While micronutrients are required by a plant for growth, the amount needed is small in comparison to macro nutrients (N, P, and K). Nevertheless, deficiency of a micronutrient can be just as yield limiting as the deficiency of a macronutrient. Such parameters are studied here.

### 2 Experimental

- 1) **pH:-** The most significant property of soil is its pH level, Its effects on all other parameters of soil. Therefore, pH is considered while analyzing any kind of soil. If the pH is less than 6 then it is said to be an acidic soil, the pH range from 6 -8.5 it's a normal soil and greater than 8.5 then it is said to be alkaline soil.
- 2) **Electrical conductivity:-**Electrical conductivity is also a very important property of the soil; it is used to check the quality of the soil. It is a measure of ions present in solution .The electrical conductivity of a soil solution increases with the increased concentration of ions. Electrical conductivity is a very quick, simple and inexpensive method to check health of soils. It is a measure of ions present in solution. The electrical conductivity of a soil solution increases with the increased concentration of ions.
- 3) **Nitrogen (N) :-** Nitrogen in soil and its determination is often carried out as an index of nitrogen availability. Percent of nitrogen is calculated by using boric acid and standard  $H_2SO_4$
- 4) **Potassium (K):-** Potassium was found in the range of low, medium , high (table no.1). K though present in small amount in soil sample, plays a vital role in the metabolism of fresh water and considered to be an important micronutrient. The K is relatively abundant in the earth's crust, most of it is not accessible to plant.
- 4) **Phosphorus:-**Phosphorus is a most important element present in every living cell. It is one of the most important micronutrient essential for plant growth. Phosphorus most often limits nutrients remains present in plant nuclei and act as energy storage.
4. **Chlorides:-**Most of the chlorides are water soluble and can be determined directly in soil solution by titrating them against silver nitrate solution using potassium dichromate as indicator.
6. **Carbon:-**Soil organic carbon is the basis of soil fertility. It release nutrient for plant growth, promotes the structure, biological and physical health of soil, and is buffer against harmful substances. Increasing soil organic carbon has two benefits as well as helping to mitigate climate change, it improves soil health and fertility. Many management practices that increase soil organic carbon also improve crop and pasture yields

### 3. Result and Discussion

The values of physicochemical parameters are presented in table

PARAMETER	Kaloli	Tamkade	yerad	shiral	Mendhoshi	SAKHARI
<b>PH</b>	6.5	5.7	7.4	8.1	7.3	5.3
<b>EC (M mhos/cm)</b>	0.7	0.4	0.5	0.41	0.1	0.6
<b>N (kg/ha)</b>	31.2	40	27	32	31.5	40
<b>K (kg/ha)</b>	42.36	46.49	55.56	37.5	35.5	44.5
<b>P (kg/ha)</b>	4.6	3.7	5.1	3.5	4.8	5.5
<b>ORGANIC C (kg/ha)</b>	32.5	35	29	37	38	42
<b>Percent Chlorides</b>	85.2	56.8	68,16	73.84	79.52	72.67

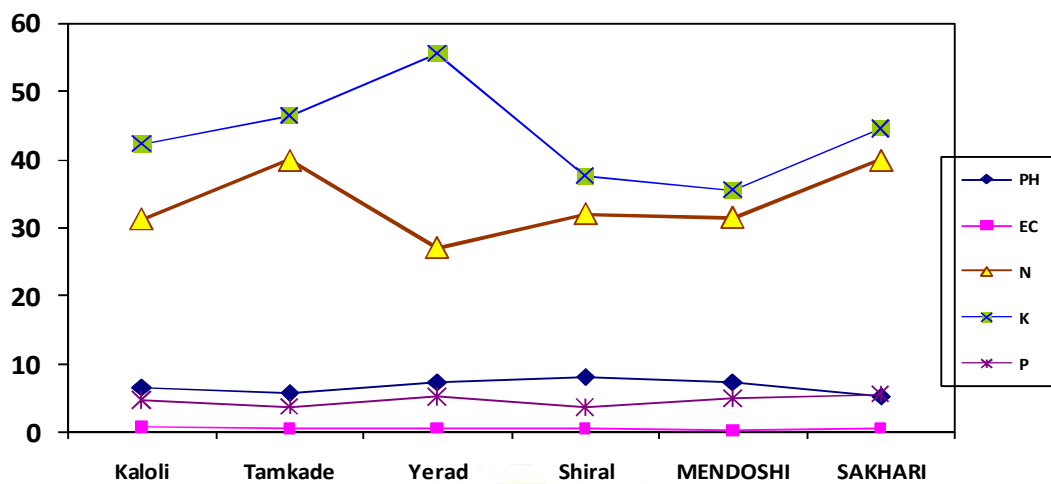

#### 4 )Conclusion

$P^H$  range is slightly acidic. Whereas EC range is normal. Nitrogen content present in Kera River is slightly high and phosphorus content is very low. Potassium content is increases from Kaloli to sakhari and organic carbon is low to medium. In this region phosphorus content is low so recommendation must have to increase the 50 % in P. So dose for per hector is N: P: K is 100:100:50 The region around the catchment area of Kera River is mostly used for cultivation for rice if we use above recommendation. This land is also important for production of Nachane, Wheat, Tur etc plants.

#### References

1. B. K. Sharma, 1984. Environmental Chemistry, 4-20
2. 3- soil and soil management (ninth edition), 2014, 37-62
3. Quantifying journal of soil on crop growth using apparent soil electric conductivity measurement, European journal of agronomy ,volume- 64 , march 2015, page 8-20
4. Bruce R. Hoskins, Assistant Scientist, Maine Soil Testing Service/Analytical Lab,
5. Soil testing handbook For professionals in Agriculture, horticulture, nutrient and residuals Management ,Third edition, 78-107

## Study of Physico-Chemical Water Parameter of Bhogavati River, Kolhapur, India.

<sup>1</sup>Rohini Kamble, <sup>2</sup>M. V. Sutar, <sup>3</sup>T. V. Sathe and <sup>4</sup>S. S. Patil

<sup>1,2,3</sup>Department of Zoology

Shivaji University, Kolhapur.

<sup>4</sup> Krishna Mahavidyalaya Rethare Bk

### Abstract

Physico-chemical parameter study is very important to get exact idea about the quality of water and compare results of different physico-chemical parameter values with standard values. In present study the water pollution is rapidly increased due to rapid industrialization and over population. Hence there is need to examine physico-chemical parameter of Bhogavati river, Kolhapur. The higher pH value was recorded in month of Sep and lower pH value was recorded in month of March. River water bodies will show changes naturally in temperature seasonally and daily. The water temp is higher in summer season and lower in winter season. In the month of April to May DO are increased and in the month of Dec to March and June to Aug DO is decreased. Free CO<sub>2</sub> of water sample recorded invariable throughout the year. In water bodies the CO<sub>2</sub> was increased in month of Dec and decreased in month of Jan. BOD value is variable throughout the year.

**Key words** – Physico-chemical parameters, Bhogavati River, Water Pollution.

### Introduction

Water is considered to be main requirement of the ecosystem. Water is needful to all living organism for survival and growth. According to WHO the water quality of about 70% river water has contaminated due to the waste discharged from the human and industrial activities, downstream, agricultural runoff, urban runoff, animal waste, sewage. The quality of river water has deteriorated which affects aquatic life as well as human (Gupta *et. al.*, 1992). Water pollution has created serious impact on human life due to various water born diseases leads to decreased food intake and nutrients absorption, malnutrition reduced resistance to infection and impaired physical growth. The physico-chemical parameter study is very important to get exact idea about the quality of water (Begum *et. al.*, 2005).

Physico-chemical parameter study is very important to get exact idea about the quality of water and compare results of different physico-chemical parameter values with standard values. In present study the water pollution is rapidly increased due to rapid industrialization and over population. Hence there is need to examine physico-chemical parameter of Bhogavati river, Kolhapur.

### Materials and Methods

#### Study area-

The origin of Bhogavati River rise in the Sahyadris. The Bhogavati River basin is bounded between 16<sup>o</sup> 1945 N to 16<sup>o</sup> 4430 N latitude and 73<sup>o</sup> 50 is to 74<sup>o</sup> 1150 E longitude. Area of Bhogavati River is 410.62 Sq. Km. The source of water of Bhogavati River have now been impounded to form the Radhanagari tank for the purposes of both irrigation and hydro-electricity.

#### Method-

In study area different sites were selected and sampling were collected from study area in Jan 2018 to Dec 2018 by using 200ml plastic containers during early morning. The collected water samples from different locations of study spots then brought to laboratory for physicochemical parameter study in laboratory by standard method described in the Handbook APHA (2005).

#### Result-

The physico-chemical parameter of Bhogavati River are recorded in Table 1-6. Table 1 : Physico-chemical parameter of Bhogavati River

Months	pH	Temp 0 <sup>c</sup>	OD Mg/l	Free CO <sub>2</sub> Mg/l	BOD Mg/l
Jan	8.07	24	6.1	2.9	3.75
Feb	8.1	23	7.1	3.97	3.48
Mar	7.5	24	9.15	4.52	4.75
Apr	8.6	25	11.8	4.3	4.89
May	8.9	26	11.98	5.97	8.79
June	8.37	26	9.08	4.11	6.72
Jul	8.27	22	9.15	6.9	6.69
Aug	8.29	23	9.7	6.15	7.51
Sep	8.16	24	10.9	7.8	5.65

Oct	8.2	24	11.77	8.55	6.47
Nov	7.55	23	9.55	10.55	4.56
Dec	7.9	20	8.1	10.5	5.70

- 1) pH  
The pH of River water is the measure of how acidic or basic the water. In present study the higher pH value was recorded in month of Sep (8.67) and lower pH value was recorded in month of March (7.7).
- 2) Temperature is essential for water quality parameter. River water bodies will show changes naturally in temperature seasonally and daily. The water temp is higher in summer season and lower in winter season.

Table 2: Monthwise pH of Bhogavati River

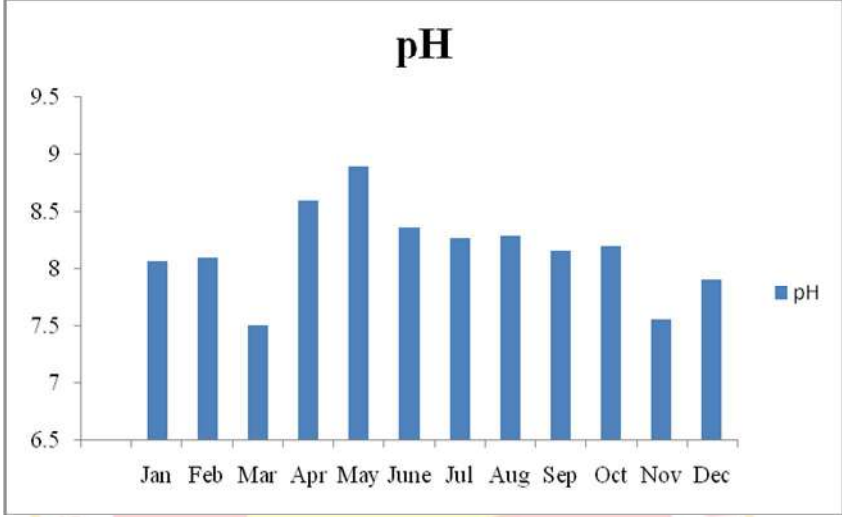
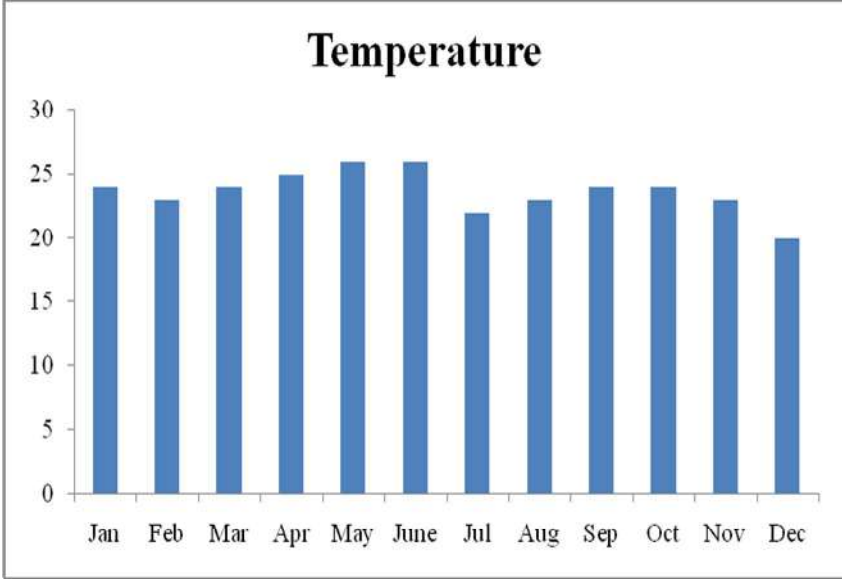

Table 3: Monthwise temperature of Bhogavati River



- 3) In study area the Dissolved oxygen are variable. In the month of April to May DO are increased and in the month of Dec to March and June to Aug DO is decreased.
- 4) Free CO<sub>2</sub> of water sample recorded invariable throughout the year. In water bodies the CO<sub>2</sub> was increased in month of Dec (10.19) and decreased in month of Jan (2.09).

Table 4: Monthwise dissolved oxygen of Bhogavati River

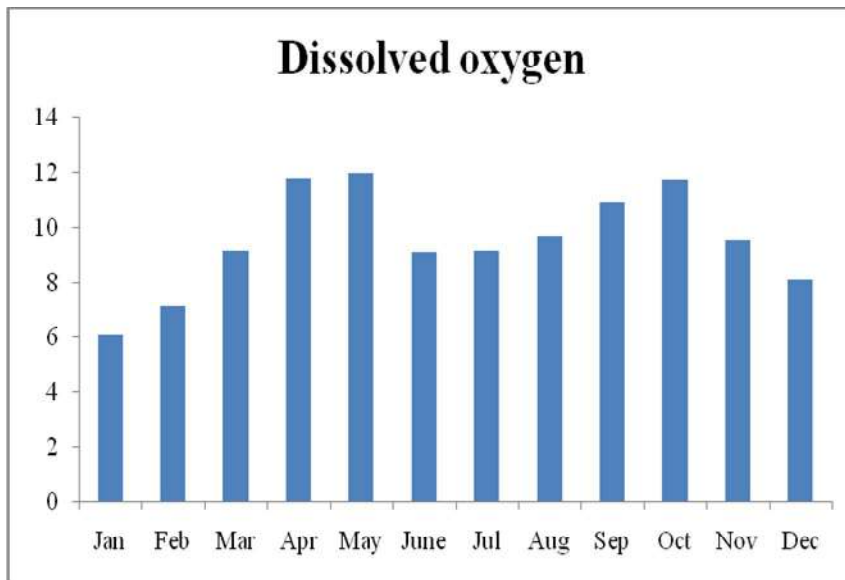
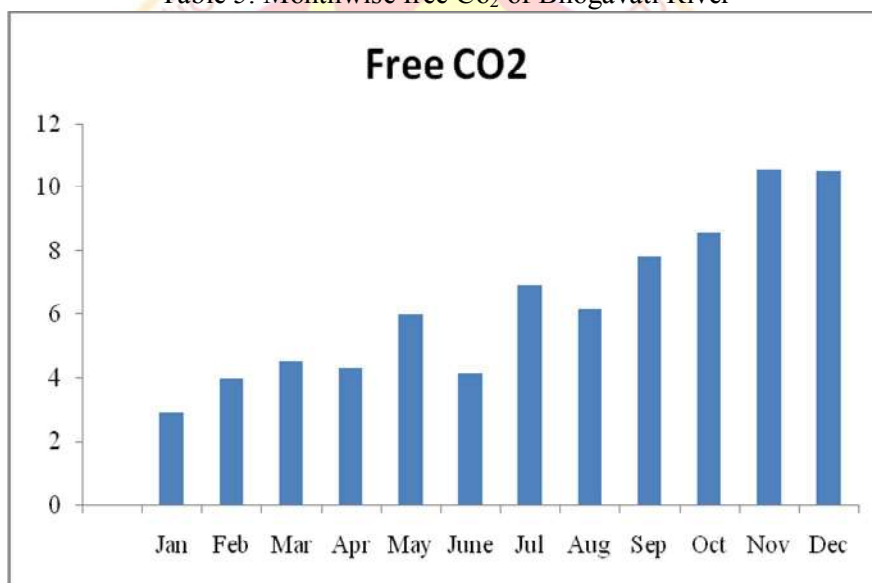
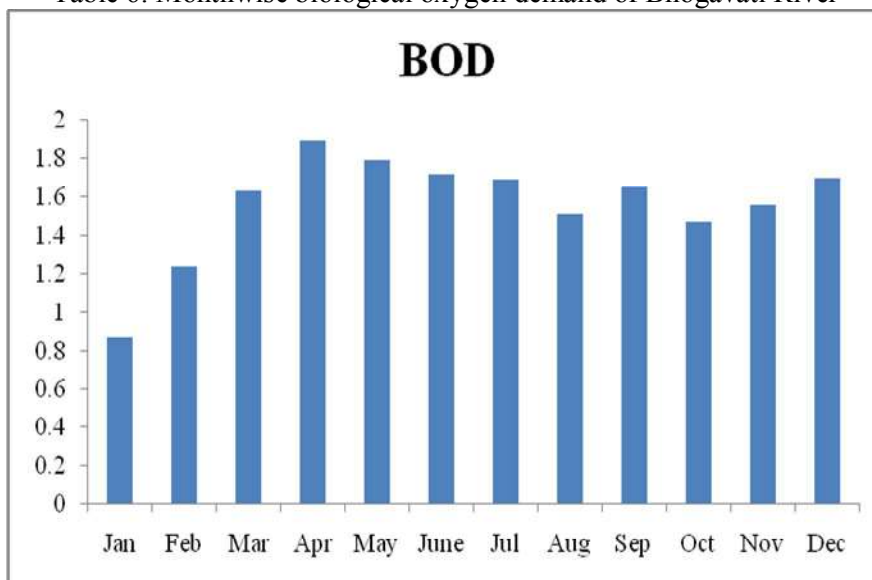

Table 5: Monthwise free CO<sub>2</sub> of Bhogavati River



5) In present investigation BOD value range between 3.75 to 8.79 Mg/L. It is variable throughout the year.

Table 6: Monthwise biological oxygen demand of Bhogavati River



**Discussion-**

According to Pankow (1991) for aquatic organisms dissolved oxygen is essential. pH indices concentration of Hydrogen ions. pH is most important in determining of corrosive nature of water. pH was positively correlated with electrical conductance and total alkalinity (Gupta,2009). Measurement of the average is thermal energy of substances known as temperature. According to Clarke (2017) hot and cold are both arbitrary terms. Water temperature controls the rate of all chemical reactions and affects of aquatic insect growth, reproduction and immunity. Do is one of the most important parameter. Its correlation with water body gives information. Do decreased due to increase in temperature and metabolic activity. CO<sub>2</sub> is the most important green house gas on earth. It fluxes across the air-water and often a measure of the net ecosystem production metabolism of the aquatic system (Smith, 1997). BOD is a measure of organic material contamination in water. BOD is also measure amount of oxygen utilizes by microorganisms in stabilizing the organic matter. It is an indicator of amount of oxygen present in a water body (Dutta and Dutta, 2000).

**Conclusion-**

In present study concluded that all parameter for Bhogavati River water were useful for drinking, Agricultural and Domestic purposes. The water of Bhogavati River not yet to be polluted.

**Bibliography –**

1. Alhejoj, I., Salameh, E and Bandel, K. 2014. An effective indicator of water bodies conditions in Jordan. *Int. J. Sci. Res. Env. Sci*, 2(10):361-370.
2. APHA (1995). Standard methods for the examination of water and wastewater, American public health. Association, 20<sup>th</sup> Edition, Washington, USA.
3. Baekken, 1981. Saeasonal fluctuation of physical and chemical parameter of weir basin in a regulated west Norwegian River. *Hydrobiology Research*, 12(1).
4. Balaram, P. 2005. Insect of tropical streams. *Curr. Sci.* 89:914.
5. Baptista, D.F., Buss, D.F., L.G. Dias, J.L. Nessimian, E.R. Da Silva, A.H. De Moraes, S.N. de Carvalho, M.A. De Oliveira, Andrade L.R. 2006. Functional feeding groups of Brazilian ephemeroptera nymphs. *Int. J. Lim*, 42 (2), 87-96.
6. Bauernfeind, E. and Moog, O. 2000. The assessment of ecological integrity of mayfly; a methodological approach. *Hydrobiologia*, 422/423: 71-83.
7. Begum, A., S. Noorjahan, C. Dawood, Sharif, S. 2005. Physicochemical and fungal analysis of water parameter. *Advances in applied Science Research*, 2(2).pp 185-189.
8. Clarke, A. 2017. Principles of thermal ecology, Oxford, 11-455.
9. Dutta S., Dutta, A. 2000. Physico-chemical parameter of potable water of Cubasa Urban area some correlation, vol 27,85-88.
10. Gupta and Hussain, 2017. Effect of physiochemical and biological parameter on the quality of river water of Narmada, Madhya Pradesh, India. *Water Science*, 31(1), 11-23.
11. Gupta, D. P, Sunita and J. P. Saharan 2009. Physicochemical Analysis of ground water of selected area og Kaithal City (Haryana) India, *Researcher*, 1(2),pp1-5.
12. Gupta, S., Micheal, R. and Gupta, A. 1992. Laboratory studies on the Life cycle and growth of *Cloeon* sp. (Ephemeroptera: Baetidae) in Meghalaya State, India. *Aquatic Insects*, 15(1): 49-55.
13. Pankow, J. F. 1991. Aquatic chemistry Concepts. 1<sup>st</sup> Edition. 13:978.
14. Smith, S. V, 1997. Annual cycle and interannual variability of ecosystem metabolism in a temprate climate embayment, *Ecological monographs*, 67,509.
15. Thoravat A. R, Sonaje, N, Mujumdar M, and swami V. 2012. Astudy on the Physico chemical characteristics of Panchganga river in Kolhapur city, MS, India. *Research journal of Chemical Sciences*. 2(8), 76-79.
16. WHO guidelines for drinking water quality. 2<sup>nd</sup> edition. Recommendation. World Health organization Geneva, 1, pp 30-113.

**Impact And Assessment Of Sewage Discharge On Water Qualities Around Municipal Sewage****S.H. Mane<sup>1#</sup>, B. S. Kamble<sup>2</sup>,**<sup>1#</sup>Department of Chemistry, Br.Balasaheb Khardekar College, Vengurla.416516, (MS) India<sup>#</sup>Research Scholar, J.J.T.U., Rajasthan, 333001, India<sup>2</sup>Mudhoji College, Phaltan, Satara, (MS) India**Abstract –**

*The diverse activities of municipal sewage water and its treatment are being adversely affected on water and soil. This paper discusses the impact of municipal sewage water on the physico-chemical and bacterial parameters of the water around sewage water samples were collected around the sewage and analyzed to evaluate the impacts of sewage discharge on the water quality parameters. The physico-chemical (pH, Electric conductivity (EC), Turbidity, Total hardness (TH), Total dissolved solids (TDS), Chemical oxygen demand (COD), Chlorides, sulphate, nitrate, trace metals) and bacterial (total bacteria) properties of the underground water samples were analyzed and results obtained are discussed by compared with permissible limits of the drinking water set by Indian standards. The physico-chemical analysis of the water samples showed that higher values of EC, TH, COD, nitrate, sulphate and trace metals contamination in the underground water. Bacterial analysis found that contamination of harmful bacteria in all the water around sewage. The results obtained confirm that all the water samples around sewage are highly contaminated and unfit for the drinking purposes. Possible sources and reasons for the underground water contamination are discussed and alternative techniques for the control of the underground water contamination are suggested.*

**Keywords :** Sewage water, Chemical oxygen demand, Underground water, Water quality, Physico-chemical parameters etc.

**Introduction –**

Municipal sewage discharge is one of the problems and sewage water treatment is perhaps the most challenging environmental problem in India and all over the World. Various efforts and research are being vigorously pursued to complete treatment and healthy discharge or reuse sewage water commonly contains both solids wastes and liquid wastes generated by various human activities and also sewage water contains various trace metals and metal compounds. Now a day, both surface and ground water resource like industrial effluents, agricultural discharge and municipal waste water associated with large amount of inorganic and organic toxic pollutants along with harmful pathogens<sup>[1]</sup>. In most of the developing countries have huge debt burdens and due to population explosion and rapid urbanization, people rely heavily on water resources and polluting in the absence of better alternatives<sup>[2-3]</sup>. Discharge of untreated or partially treated sewage water to the open fields cause to contamination of upper soil, surface water and the underground water. Underground water contamination is generally irreversible and once it is contaminated, it is difficult to restore the original water quality of the aquifer. Excessive mineralization of ground water degrades water quality production an objectionable taste, odour and excessive hardness. Although the soil mantle through which water passes acts as an adsorbent retaining a large part of colloidal and soluble ions with its cation exchange capacity, but ground water is not completely free from the menace of chronic pollution. The main factor affecting ground water pollution is soil types and discharge of liquid pollutants on the upper surface of the soil. The quality of final treated municipal sewage water discharged to the open field plays an important role on the underground water quality around treatment plants and discharging areas. Sewage water discharge is major component of water pollution, contributing to oxygen demand and nutrients loading of the water bodies; promoting toxic; algal blooms and leading to a destabilized aquatic ecosystem problem is compounded in areas where wastewater treatment systems are simple and not effective<sup>[4-6]</sup>. The impact assessment of surface water and the underground water by various sources and activities is very crucial to safeguard public health and the environment. The present study is reevaluated that there was an adverse impact on the physico-chemical and bacterial characteristics of the underground water as result of discharge of inadequately treated municipal sewage water from the sewage treatment facility. This poses a health risk to several areas which are located near or around the sewage discharging areas and rely on the receiving water bodies (bore wells) primarily as their sources of domestic water.

**Material and Methods –**

Treatment plant has capacity of about 2000-5000 m<sup>3</sup>/day receives domestic sewage, as well as run-off water during rainy season. Sewage treatment is based on the conventional treatment techniques like sedimentations, flocculation, oxidation pond, activated sludge system, etc. As treated final sewage is discharged into the open fields located around the treatment plant and most of the discharging area is situated in the western part of the treatment plants.



This study was performed by descriptive and interrupted method on the underground water around municipal sewage water treatment plant. Totally 8 underground water samples were collected by using available bore wells (250 to 350 feet in depth) located around the treatment plants and near the discharge areas (1 to 3 km radius from treatment plant). Treated final sewage water sample which was releasing to the open field was also collected from the discharge point of the treatment plant (outlet). All the groundwater samples were collected in 1L glass bottles which were pre-cleaned by washing with non-ionic detergents, rinsed in tap water, 1:1 hydrochloric acid and finally with demonized water. Before sampling, the bottles were rinsed with the underground water to be analyzed and collected. Then the samples were carefully transported to the laboratory for analysis within short duration after collection with maintaining the temperature of 4°C for the determination of physico-chemical and bacterial parameters. The determination of water quality parameters was carried out by standards techniques<sup>[7]</sup> and important parameters which are taking main role in the human health were considered (Table 1). As obtained underground water quality parameters were compared with water quality standards for the drinking purposes<sup>[8-9]</sup>.

### Results and Discussion –

The physico-chemical and bacterial qualities of the underground water around the treatment plants and near the discharge areas are determined and the results obtained are shown in Table 2. The results obtained are clearly indicating that there is a wide variation in the underground water quality parameters. The results obtained from the physico-chemical and bacterial analysis of final treated sewage water sample (TS) at discharged point showed that high level contamination of organic, inorganic and bacterial pollutants (Table 2). It clearly confirmed that it may cause negative impact on the surrounding environmental elements like water and soil. The pH value of all the underground water samples are significantly varied from 6.1 to 7.19 at different sampling sites (G1 to G8) and treated sewage water sample (TS) at discharging point showed the pH value 9.1. The pH values of water samples showed slightly acidic in nature. All the underground water samples were showed odorless and colourless with ordinary taste. The electric conductivity (EC) of water sample reveals that the levels of dissolved ionic substances in all the underground water samples are ranged between 800-1070 mmho/cm. In the present study EC values are very high and EC values are exceeded above the standard limits for the drinking purposes. Higher value of EC in water reveals that higher levels of dissolved ionic substances like trace metals and sulphate<sup>[10-11]</sup> and in the present study EC of all water samples is very high due to interfering of final discharged sewage which was showed high level sulphate and trace metals contamination at discharge point. The turbidity in all the underground water samples is varied from 2.1 to 3.8 NTU and turbidity of final treated sewage water at discharge point is 19 due to the presence of high level organics load. All the underground water samples showed acceptable limits of turbidity however the turbidity value is not exceeding the cause for rejection value of 10 NTU. The amount of total dissolved solids (TDS) in the water indicates the general nature of salinity of the water. The water contains more than 500 mg/L. TDS is not considered to be desirable for the drinking purposes. In the present investigations, TDS values are ranged between 200 to 400 mg/L and it is within acceptable level. The variation in the concentration of total hardness (TH) in the underground water samples around sewage treatment plant and TH values are in the range of 218 to 289 mg/L. TH values in the present study are slightly higher and crossed the permissible limit of 200 mg/L. The permissible limit of calcium and magnesium content in drinking water should be 75 mg/L and 30 mg/L respectively. According to the results obtained in the present study, calcium (96 to 110 mg/L) and magnesium (38-52 mg/L) concentration in all the underground water samples around the sewage treatment plants are very higher than the permissible level. The Ca and Mg contents in the underground water around the treatment plant. TH of water mainly depends upon the amount of calcium and magnesium salts or both. Calcium and magnesium ions in the water can cause scale buildup during domestic usage and cause unfit for household usage. Some time regular use of hard water cause health problems like hair fall, itching, skin and kidney disorders and other health risk<sup>[12-14]</sup>. The permissible limit of chloride contents of water for the drinking purposes is 250 mg/L. The results obtained showing that the chloride contents in all the underground water samples obtained showing that the chloride contents in all the underground water samples are ranged between 110 to 121 mg/L and chloride contents in all water samples are within permissible limit for the drinking purposes. Sodium sulphate and magnesium sulphate exert a cathartic action in the human being and also sulphate associated with respiratory illness. Therefore, the recommended limit of sulphate contents in the drinking water is 200 to 250 mg/L. The results obtained in the present study showed that sulphate contents in all the underground water samples is ranged between 200 to 260 mg/L. Sulphate contents is higher than permissible limit and it is clearly indicating that the unsuitability of the underground water for the drinking purposes. The amount of nitrate in the water indicates the biological contamination of water. According to the obtained results, the occurrence of slightly higher amount of nitrate in few underground water samples. The maximum permissible limit of nitrate in the drinking water is 10 to 45 mg/L. About 32.2 to 2 mg/L of nitrates contents in the underground water samples indicates the presence of

large amount of organic load in the underground water samples. Few underground water samples are showed slightly higher concentration of nitrates and the nitrate level is above the permissible limit. Through which we can depict that the underground water is affect by the discharge of sewage water which contains high amount of organics load. Percolation of highly contaminated (organic and inorganic pollutants) waste water or effluents into the ground for a prolonged period affects the underground water table of that locality<sup>[15-20]</sup>. In the same way high pollutants loaded and final discharged sewage water percolated into the ground and contaminated the underground water around the sewage treatment plant. Levels of chemical oxygen demand (COD) in all the underground water samples are range between 160-212 mg/L. COD of all water samples is considerably very high and it confirmed that presence of organic pollutants in the underground water. It clearly indicated that sewage water released from the treatment plant containing high organic load is interfered with the underground water through percolation or through direct contact. In the present study determination of some trace metals like Zn, Fe, Cu, Pb and Mn in the underground water was carried out to study the trace metal contamination by sewage discharge. Showing the variations of Zinc (Zn) concentration in the underground water samples collected around sewage treatment plant. The samples collected around sewage treatment plant. The concentration of Zn is varied between 0.02 to 0.16 mg/L which is within acceptable limit value of 5 mg/L. The concentration of iron (Fe) is varied between 0.27 to 0.40 mg/L and few underground water samples such u2,3and \$5 are showed slightly higher concentration of Fe than its acceptable limit of 0.3 mg/L the concentration of Copper (Cu) varies between 0.038 to 0.07 mg/L, in the present study all the underground water samples showed acceptable amount of Cu concentration except few water samples S1, S2 and S3 (figure 11). The concentration of Cd is varied from 0.005 to 0.01 mg/L and the underground water samples S2, S4 and S5 showed higher concentration of Cd when compared to permissible level for the drinking purposes. The concentration of Pb is varied from 0.04 to 0.09 mg/L and except the underground water samples S4 and S5, all the water samples showed higher concentration of Mn when compared to present study Mn concentration is varied from 0.05 to 0.11 mg/L and few underground water samples (S4 and S8) are showed slightly higher concentration of Mn when compared to acceptable level for the drinking purposes. The present study clearly indicating that all the underground water samples are contaminated by trace metals due to the percolation or interference of discharged final sewage which consisting of higher concentration of trace metals. The acceptable limit of MPN/mL prescribed for the drinking purpose should be Zero in the total numbers of E. coli bacteria per 100 mL. The bacterial analytical results obtained in the present study. Treated sewage water sample (TS) which was collected at discharge point of the treatment plant showed higher values of total bacterial count up to 350 number/100 mL. All the underground water samples collected around sewage treatment plant are highly contaminated by E.coli bacterial in the water serves as a potential indicator of harmful bacteriological contamination. In the present study all the underground water quality analysis indicated that contamination of E. coli bacteria, this is due to direct contact of discharged final sewage water which is consisting of high level harmful bacteria. Bacterial contamination of underground water is a serious environmental impact related to public health risk and restoration of original aquifer.

The physio-chemical and bacterial analysis of the underground water samples around sewage water treatment plant clearly indicating that most of all the underground water samples are highly contaminated by chemically as well as bacteriologically. All the underground water samples showing higher values of EC, TH, NO<sub>3</sub>, sulphate, COD, and trace metals like Cu, Fe, Cd, Pb and Mn, which are the major water quality parameters with concern to human health. Most importantly, the aquifer around sewage treatment plant is highly contaminated by harmful bacteria, which cause major health risk in surrounding peoples. In the present study higher values of EC and TH were found in all the underground water samples, this is because of percolations and entering of high concentrated and alkaline natured sewage water which was discharged by sewage treatment plant into the open field. Also, chemical weathering of trace metals and salts from the rock during percolations of highly alkaline acidic sewage water through soil and rocks leads to increase the concentration of EC and TH in the ground water around treatment plant<sup>[11-12, 16]</sup>. Based on the obtained results, the discharged sewage water consisting large amount of organic load, trace metals and bacteria. Infiltration or percolations of such highly polluted sewage water in the underground water leads to increased concentration of NO<sub>3</sub>, sulphate, COD, trace metals and total bacteria. Direct contact of discharged highly contaminated final sewage water through few opened bore wells which are located inside the discharge field. It is a severe impact on the underground water by open field discharge of incompletely or partially treated and highly contaminated sewage water. As contaminated underground water through a single bore well may cause contamination of whole aquifers and leads to unfit for domestic use or drinking purposes. Interlinks and geological circulation of such polluted underground water may contaminate the whole fresh aquifers and restricts their domestic use. Moreover contamination of trace metals like Cd, Pb and Mn with underground water is further causes severe problems to human health and it is an irrecoverable impact on the underground water resources. Also it leads to many disorders and diseases like renal failure, kidney stone, gastrointestinal problems, brain fever etc. The

presence of Cu, Fe, Cd, Pb and Mn will interfere with some metabolic activity which will directly affect the central nervous system leading to abnormal condition or death. It is important to reduce the contamination of underground water by discharge of sewage water after its complete treatment and removal of toxic pollutants.

**Table No. 1****Details of analytical methodology and drinking water quality standards**

Sr. No.	Parameters	Methods	Units	Permissible limits for the drinking purposes
1	pH	Potentiometry	pH	6.5-8.5
2	Color	-	Hazan Unit	5
3	Odour	-	Mho/cm	-
4	Electrical Conductivity	Electrolytic	NTU	300
5	Turbidity	Nephelometric	mg/L	10
6	Total dissolved solids	Gravimetric	mg/L	500
7	Total hardness	EDTA titrimetric	mg/L	200
8	Calcium	EDTA titrimetric	mg/L	75
9	Magnesium	By difference	mg/L	< 30
10	Chloride	Argentometry	mg/L	250
11	Sulphate	Nepheloturbidimetry	mg/L	200
12	Nitrates	Spectrophotometry	mg/L	45
13	COD	Reflux method	mg/L	30
14	Zinc	ET-AAS	mg/L	5
15	Iron	ET-AAS	mg/L	< 0.3
16	Copper	ET-AAS	mg/L	0.05
17	Cadmium	ET-AAS	mg/L	0.01
18	Lead	ET-AAS	mg/L	< 0.05
19	Manganese	ET-AAS	mg/L	0.1
20	Total Coliform bacteria	MPN	Count/100mL	Zero

**Table 2** :Physio-chemical and bacteriological quality of ground water around municipal sewage water treatment plant (TS – Treated sewage water samples collect at discharge point, S1 to S8 underground water samples around sewage water treatment plant and discharge field)

Parameter	TS	S1	S2	S3	S4	S5	S6	S7	S8
pH	9.1	6.1	6.4	6.0	6.6	8.19	6.81	8.33	6.71
Colour	-	-	-	-	-	-	-	-	-
Taste	-	-	-	-	-	-	-	-	-
Odour	Pungent	-	-	-	-	-	-	-	-
EC	2058	1069	1070	800	816	1020	958	1056	1030
Turbidity (NTU)	19	3.0	2.5	3.8	2.8	2.8	2.1	3.0	3.0
TDS (mg/L)	1900	315	280	280	300	200	200	400	300
TH (mg/L)	368	240	267	289	273	218	236	268	240
Ca	160	102	102	110	110	96	100	102	100
Mg	75	46	46	52	45	38	38	42	42
Cl (mg/L)	131	110	111	121	112	110	110	112	118
SO <sub>4</sub> (mg/L)	450	230	212	260	220	200	215	230	200
NO <sub>3</sub> (mg/L)	180	48	44	52	35.3	32.2	41.5	39.7	50
COD(mg/L)	690	160	180	212	152	165	160	162	180
Zn (mg/L)	1.80	0.13	0.13	0.09	0.11	0.02	0.16	0.09	0.08
Fe (mg/L)	1.40	0.27	0.35	0.40	0.28	0.32	0.31	0.28	0.30
Cu (mg/L)	0.23	0.07	0.056	0.066	0.038	0.048	0.038	0.033	0.021
Cd (mg/L)	0.11	0.01	0.013	0.008	0.017	0.012	0.010	0.005	0.005
Pb (mg/L)	0.31	0.057	0.06	0.078	0.049	0.040	0.09	0.056	0.077
Mn (mg/L)	0.35	0.09	0.081	0.060	0.12	0.05	0.1	0.06	0.11

Total bacteria (Num/100ml)	350	22	18	32	15	12	16	20	30
----------------------------	-----	----	----	----	----	----	----	----	----

### Conclusion-

The underground water quality around sewage treatment plant and discharge field has been highly contaminated by organic and inorganic pollutants. Contamination of harmful bacteria is the major and irrecoverable impact caused by unscientific discharge of the sewage water in to open field. The results obtained showed that the underground water quality is very poor and not suitable for the drinking purposes at all. High amount of organic and inorganic pollutants are observed in the underground water around sewage treatment plant and cause severe problem to the human health. One of the important controlling method is providing a proper concrete lining to sewage flowing channels and around the bore wells which are located inside the discharge open field, it will reduce risk of direct contamination. Scientific maintenance and continuous monitoring of sewage treatment plant and analysis of sewage water both at inlet and outlet of treatment plant is most important. Moreover the treatment plant need to be implemented advanced treatment techniques like adsorption, absorption, electrolysis, advanced filtration and disinfection etc. to complete removal of toxic organic and inorganic pollutants and harmful bacteria. The results of this study would greatly facilitates the health and sanitary authorities to monitor and to control contamination of the underground water which is the major source of drinking water. Moreover, the municipal solid waste dumping yard is located very near to final sewage discharge areas and there are chances to contamination of the ground water by leaches. It needs more detailed study on contamination of leaches and toxic chemical compounds through leaches and sewage discharge.

### Reference –

1. Okoh A.I., Odjadjare E.E., Igbinsosa E.O. and Osode A.N., Wastewater treatment plants as a source of microbial pathogens in the receiving watershed, Afr. J. Biotech, 6(25), 2932-2944 (2007)
2. Aina E.O.A. and Adedipe N.O., Water quality monitoring and environmental status in Nigeria, FEPA Monograph 6, FEPA, Abuja, Nigeria, 239(1996)
3. Calamari D. and Naeve H., Review of pollution in the African aquatic environment. Committee for Inland Fisheries of Africa (CIFA) Technical paper No. 5, FAO, Rome, 118, (1994)
4. Department of Water Affairs and Forestry (DWAF) and Water Research Commission (WRC), South African water quality management series, Procedures to Assess Effluent Discharge impact, WRC Report No. TT 64/94, Pretoria (1995)
5. Morrison G., Fatoki O.S., person L. and Ekberg A., Assessment of the impact of point source pollution from the Keiskammabock sewage treatment plant on the Keiskamma river-pH, electrical conductivity, oxygen demanding substance (COD) and nutrients, Wat. SA., 27(4), 475-480 (2001)
6. Water Research Commission (WRC), National eutrophication monitoring program, Implementation Manual, Pretoria (2000)
7. American Public Health Association (APHA), American Water Works Association (AWWA) and Water Environment Federation (WEF), Standards Method of the Examination of Water and Wastewater, (19<sup>th</sup> Ed.) American Public Health Association, Washington DC 3710 (2005)
8. Ayers R.S. and Westcot D.W., Water Quality for Agriculture, FAO Irrigation and Drainage Paper 29, Rev. 1, Food and Agriculture Organization of the United Nations, Rome (1994)
9. BIS, Indian Standards for Drinking Water, Bureau of Indian Standards, New Delhi, IS : 10500 (1991)
10. Mizumura K., Chloride ion in groundwater near disposal of solid wastes in landfills, J.Hydrol. Eng., 8(4), 204-213 (2003)
11. Tindl J. A., Lull K.J. and Gaggiani N.G., Effects of land disposal of municipal sewage sludge on fate of nitrates in soil, streambed sediment and water quality, J. Hydrol, 163, 147-185 (1994)
12. Chillers J. and Henrik A., Effect contaminated water, Glo. Wat. Haz., 25, 25-27 (1996)

## A brief review on various synthetic aproches of biologicaly active nitrogen & sulphur containing spiro-heterocycles.

**Mr. Shinde Achut Ramrao\***

Assistant Professor,  
Department of Chemistry &  
Analytical Chemistry,  
Sanjeevani Mahavidyalaya,  
Chapoli, Tq. Chakur, Dist.  
Latur-413513(Maharashtra)

**Dr. Muley D.B.**

Assistant Professor,  
Department of Chemistry,  
Shivaji Mahavidyalaya Udgir,  
Tq. Udgir, Dist.  
Latur(Maharashtra)

**Mr. Abhay S. Bondge**

Head & Assistant Professor,  
Department of Chemistry,  
Shivneri Mahavidyalaya,  
Shirur Anantpal, Dist. Latur

### Abstract:

*Spiro-heterocyclic compounds offers a great importance in the field of medicinal as well as pharmaceutical and drug chemistry. This is due to their capacious biological and pharmacological activities. Spiro compounds containing nitrogen and sulphur as a part of ring renders many applications in the area of the medicinal chemistry. This attract the more attention of the researchers towards the synthesis of novel Spiro-heterocyclic compounds. Most of the Spiro-heterocyclic compounds are isolated from the plant and some are synthesized artificially in research laboratories, which exhibit biological as well as therapeutic properties. The various biological and therapeutic activities of the Spiro compound is due to their structural characteristic that is the quaternary carbon atom is become a part of the Spiro cyclic ring. Biological activity of such compounds is enhanced by introducing nitrogen, oxygen and sulphur as a hetero atom within the Spiro-cyclic ring. This spacious character of the Spiro heterocyclic compounds tends to develop different synthetic approaches for the synthesis of such compounds and which leads to emerge the various synthetic methods for such type of biologically precious compounds. Spiro- heterocyclic compounds are synthesized by microwave assisted synthetics method, dipolar cycloaddition, Michael addition and Knoevenagel condensation reaction etc. From the above methods the dipolar cycloaddition is mostly used.*

*In the present study we try to enlist and review the various types of synthetic methodologies adopted for the synthesis of Spiro- heterocyclic compounds in various literature.*

**Key word:** Spiro-heterocyclic compounds, biological activity, pharmacological activities, Medicinal chemistry.

### Introduction:

The Spiro word come from the Latin word “spira” meaning a twist or coil. Spiro-compounds are those compounds which are polycyclic in nature which is bounded with the single carbon atom as a member of the ring. Spiro compounds are generally organic in origin with twisted structure and two or more ring are linked with the single common atom e.g Spiro[5,5]undecane (Fig1).



Spiro [5,

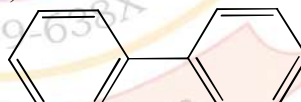

5] undecane (Fig.1)  
1, 1'-biphenyl (Fig.2)

The difference between Spiro compounds and nonspiro bicyclic compounds is that the in the Spiro compounds the two or more ring are fused by means of single common atom. But in non-Spiro bicyclic compounds such connectivity is not observed. e.g. Biphenyls (Fig2)

Spiro compounds are further classified into two classes that is carbocyclic Spiro compounds and heterocyclic Spiro compounds. In the carbocyclic Spiro compound only carbon and hydrogen is a part of the ring while in the heterocyclic Spiro compounds there is a presence of hetero atom such as nitrogen sulphur, oxygen, silicon, selenium etc. are part of the ring. E.g. Spiro [4, 5] decane and 8-azaspiro [4, 5] decane (fig.3, 4).

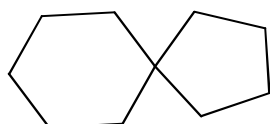

Spiro [4.5] decane (Fig.3)

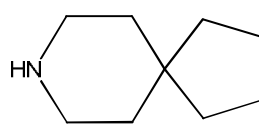

8-azaspiro [4.5] decane (Fig.4)

The Spiro compounds due to their structural characteristic shows tremendous application in the field of medical and biological sciences. The Spiro system makes compound asymmetric which is the basis for the exhibition of extensive biological activities, which is responsible for researchers most trusted area as a synthesis of Spiro- heterocyclic compounds. Spiro-heterocyclic compounds offers great importance than the carbocyclic spiro compounds. Spiro-compounds containing nitrogen sulphur and oxygen as a part of ring renders many application in medicinal chemistry. This fat attract attention of researchers for the synthesis of many novel heterocyclic compounds by using different synthetic methodologies.

Many Spiro-heterocyclic compounds are known for their potent biological activities such as antimicrobial, anticancer, antidepressant, antibiotic, anti-human immunodeficiency virus (HIV), antimalarial and antituberculosis. Spiro-heterocyclic compounds also find application in the pesticide development, analytical agent and nanotechnology for the synthesis of silver Nano particles. In the area of synthesis of spiro-heterocyclic compound the much work is done on the isatin and its derivative by dipolar cycloaddition Michael condensation, Microwave assisted green synthesis and Knoevenagel condensation reaction. In this article some of these reviews from the literature are mentioned.

### Synthetic methods of some Spiro-heterocyclic compounds containing nitrogen, and Sulphur:

Nitrogen and sulphur containing spiro-heterocyclic compounds show the immense biological and pharmacological activities. This renders the interest of the researcher to synthesize such biologically potent novel Spiro-heterocyclic compounds. Various Spiro-heterocyclic compounds were synthesized by using isatin and their derivative as starting materials. Some of the methods are discussed below.

Synthesis of Spiro-heterocyclic compounds starting from isatin is well reported by Mayuri A. et al.<sup>[1]</sup> and others in their review article "Synthesis of Spiro-heterocyclic compounds from isatin". In this they mentioned the synthesis of Spiro-heterocyclic compounds by different synthetic methods.

Rehn and coworkers reported the synthesis of pyroli-dine-2-spiro-3-(2-oxindole) **5**<sup>(2)</sup> by means of condensing isatin **1** with  $\alpha$ -amino acid derivatives **2** in the presence of methanol and water to yield azomithene ylides **3** which is followed by 1,3-dipolar cycloaddition with the dipolarophiles **4** (scheme 1)<sup>2</sup>.

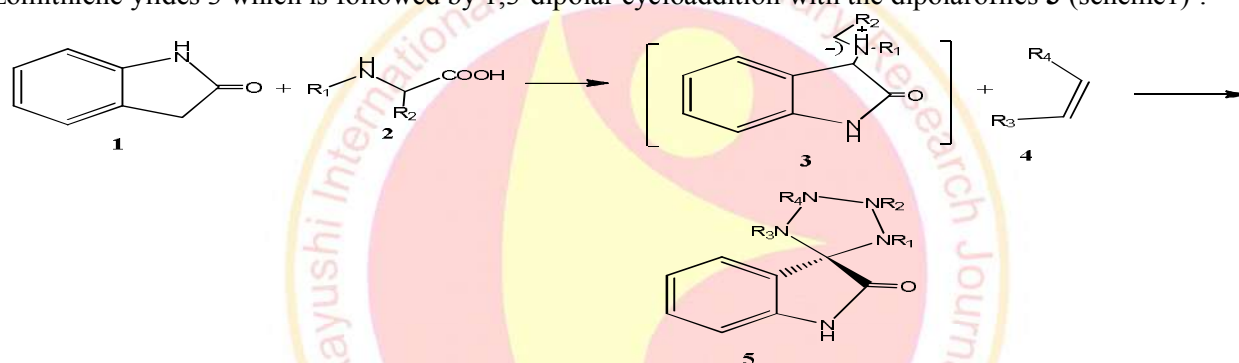

Scheme 1

Xie, Y.M.<sup>3</sup> et al and other reported the synthesis of spiro-pyrrolizidine oxindoles **8** containing two amide and ester group from maleates or maleamide **7** (Scheme 2)<sup>3</sup>.

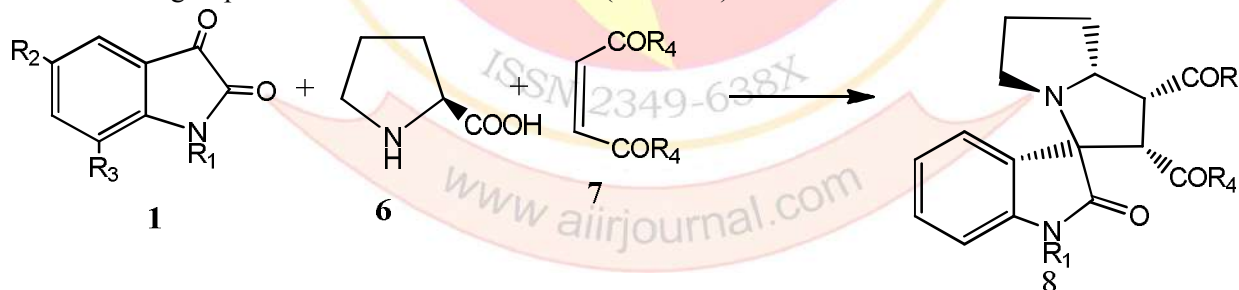

Scheme 2

Chen G.<sup>4</sup> et al and coworkers describes the synthesis of new Spiro-compound **11** by dipolar cycloaddition reaction with isatin **1**,  $\alpha$ -amino acid **10** and (E)  $\beta$ -nitro-styrene **9** resulting product shows different regioselectivity (Scheme 3)<sup>4</sup>.

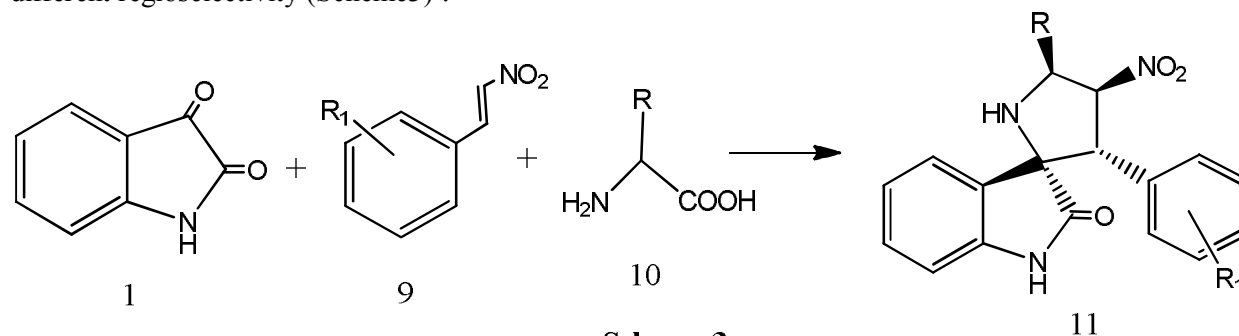

Scheme 3

Abdelhamid I.A.<sup>5</sup> et al and others reported the synthesis of oxindole derivatives of amino-4H-pyridazine **15** by Knoevenagel condensation reaction between isatin derivative **1** and active methylene

compound **12** which gives intermediate 3-cyanomethylene oxindole derivatives **13** by using DBU catalyst. Further intermediate underwent Michael addition compound **14** to yield compound **15** (Scheme.4)<sup>5</sup>.

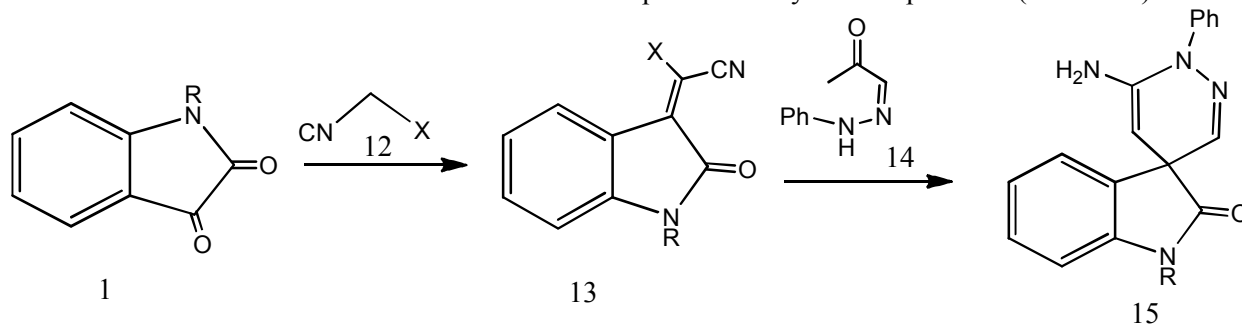

Scheme 4

Kurosh, A.M.<sup>6</sup> and other reported synthesis of Spiro-[4H-pyran-oxindole] **18** by one pot three component reaction of isatin **1** with malenonitrile **16** and ethyl acetoacetate **17**. But more efficient and wide applicable method is given by the Moghadam et al by using [BMIm]BF<sub>4</sub> as an ionic liquid catalyst. (Scheme.5)<sup>6</sup>.

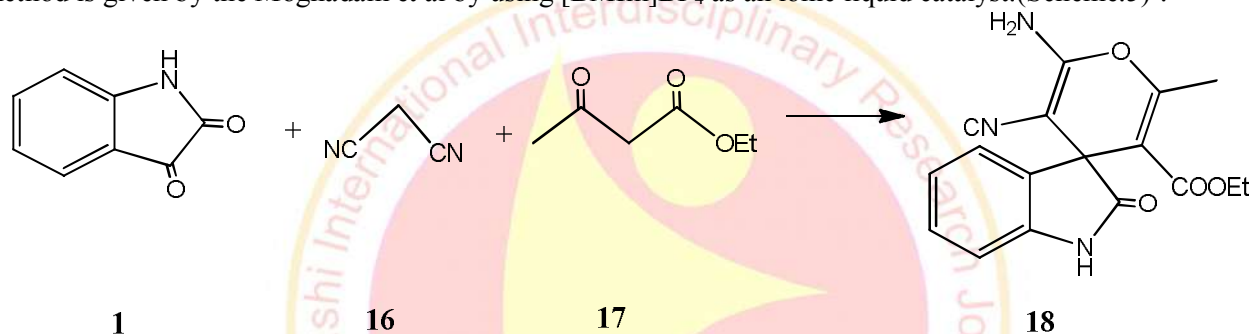

Scheme 5

Ji, S.J.<sup>7</sup> and coworkers reported multicomponent (3+2) cycloaddition reaction of isatin **1** with amino acid **6**, **19**, aldehyde **20** and 3-cyanoacetyl indole **21** results new Spiro-heterocyclic compound **22** and **23** (Scheme.6)<sup>7</sup>.

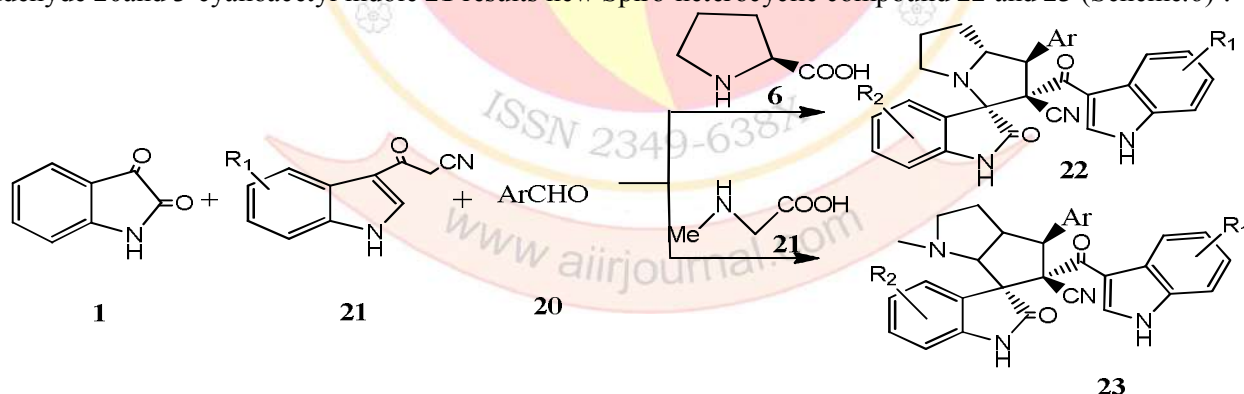

Scheme 6

K.C. Majumdar<sup>8</sup> and others advised a green highly efficient one pot three component synthetic method for synthesis of Spiro-[indoline-3,4]thiopyrano[2,3-b]indole **27** derivative by domino reaction of indoline-2-thione **24**, isatin **1** and ethyl cyanoacetate **25** in ethanol **26** (Scheme7)<sup>8</sup>.

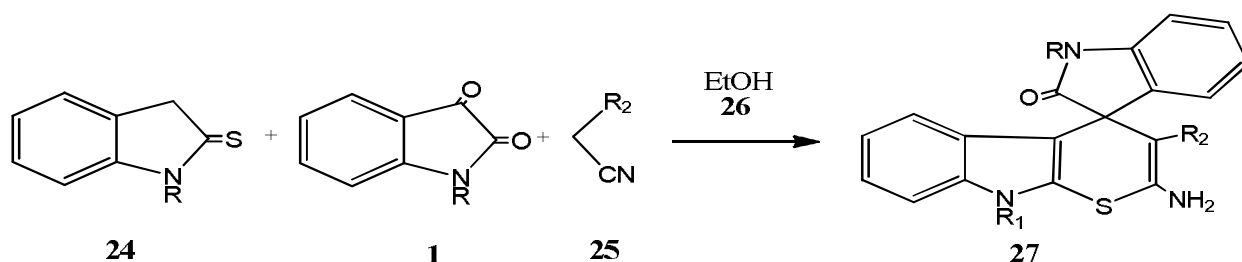

Scheme 7

K.R. Maghadam<sup>9</sup> other have reported synthesis of Spiro-[1H]-indendo[1,2-b]benzoquinoline-2H-indene-1,3-dione **28**, isatin derivative **1** with naphthylamine **29** using ionic liquid as catalyst (Scheme.8)<sup>9</sup>.

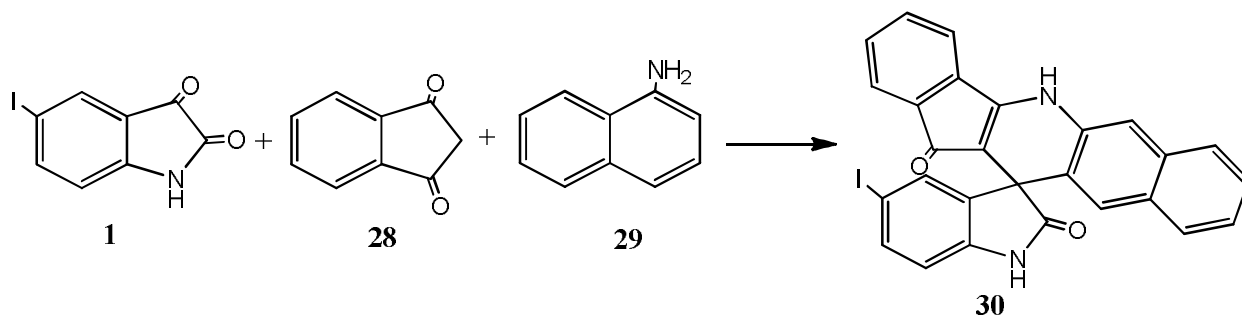

Y. Sarafi<sup>10</sup> et al and others reported the synthesis of Spiro compound **32** by using efficient catalyst amberlyst 15 undergoing electrophilic substitution reaction with isatin derivatives **1** and indoles **31** in water (Scheme.9)<sup>10</sup>

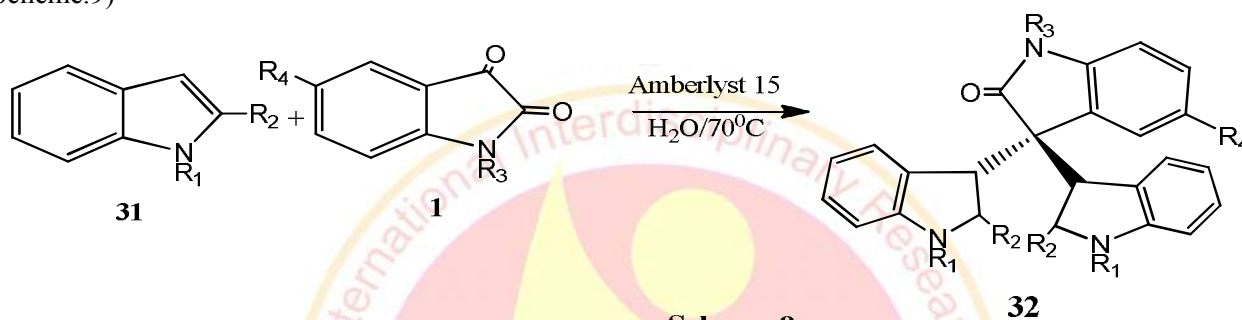

B.V.S. Reddy<sup>11</sup> et al other reported a synthesis of novel Spiro-heterocyclic compound **34** by the reaction of isatin **1** indole **33** in presence of catalytic amount of molecular iodine under mild condition.(Scheme.10)<sup>11</sup>.

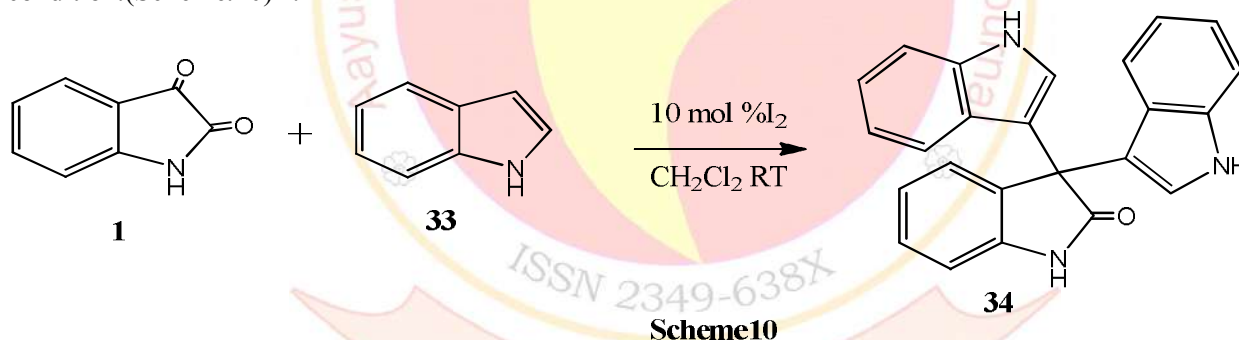

Mahammad Shahidul Islam<sup>12</sup> and other reported a synthesis of 2,4-diazaspiro[5,5]undecane-1,3,5,9tetraons **37** via cascade cyclization of [5+1] double Michael addition reaction of N,N- dimethyl barbituric acid **35** with derivatives of diaryl-divinyl ketone **36** in the presence of diethyl amine at temperature (Scheme.11)<sup>12</sup>.

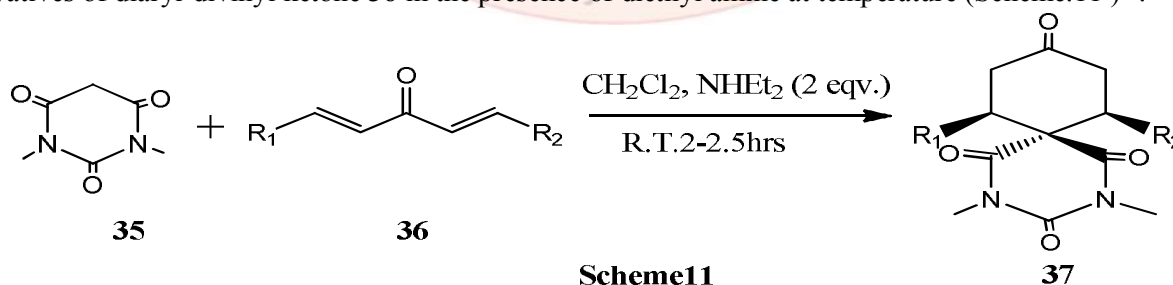

S.M. Medvedeva<sup>13</sup> et al and others reported efficient synthetic methods for spiro-heterocyclic system based on 4,4,6-trimethyl-4H-pyrrolo[3,2,1-ij] quinolone 1,2-dione **39** by cyclocondensation of 4h-pyrrolo[3,2,1-ij]quinolone-1,2-diones **38** with some 1,2 and 1,3 dinucleophiles by their three component cyclocondensation with arylamines and 2-mercapto acetic acid, malononitrile and various active methylene compounds gives their respected Spiro-compounds (Scheme.12)<sup>13</sup>.



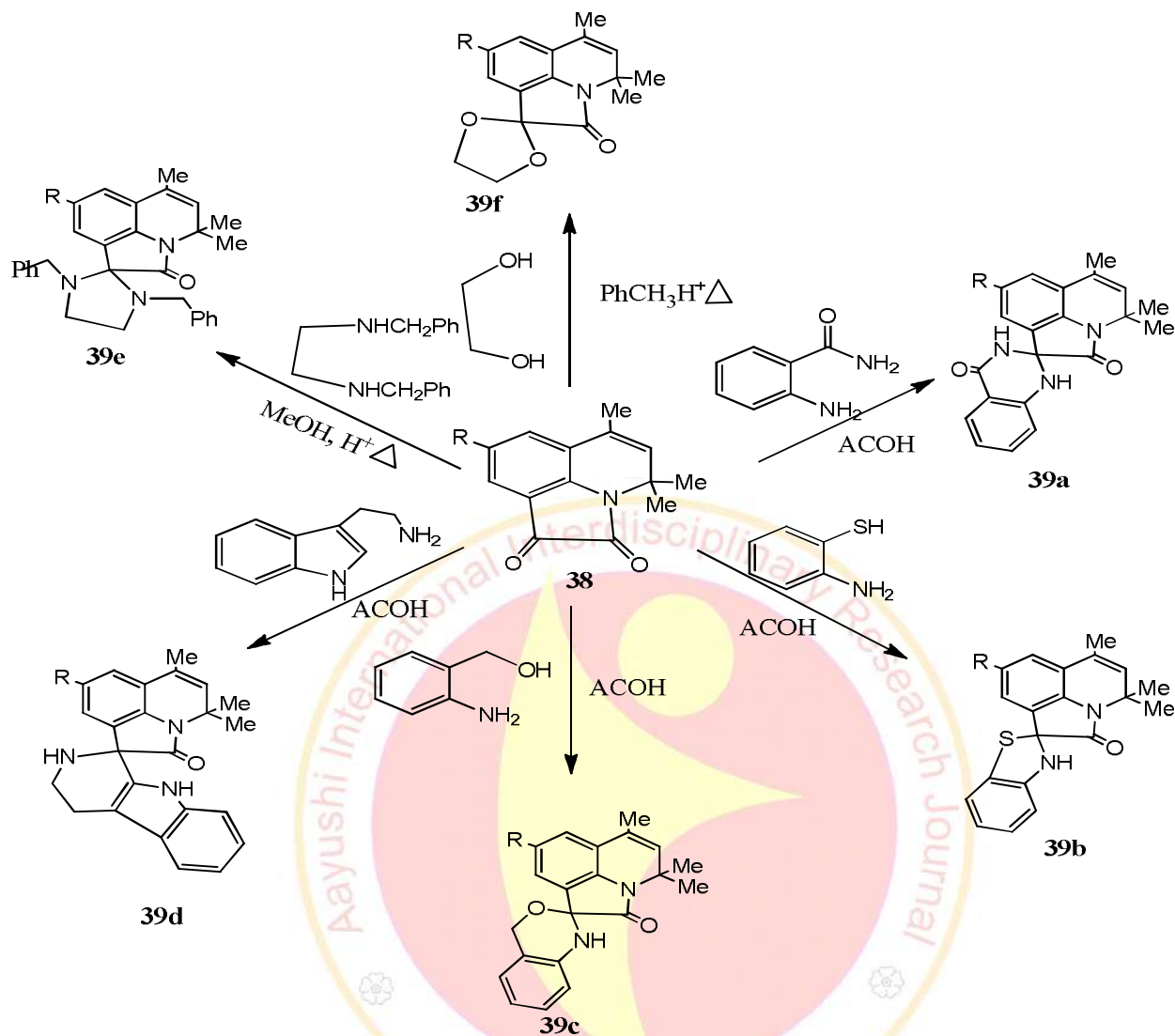

### Conclusion:

From the above brief review of literature it is concluded that for the synthesis of Spiro-heterocyclic compounds containing nitrogen and sulphur, dipolar cycloaddition as well as Michael addition methods are mostly adopted by the researchers, which is an efficient method for the corresponding synthesis of Spiro-heterocyclic compounds. From the review of literature it is clear that so much work is done on the synthesis of Spiro heterocyclic compounds starting from the isatin and its derivatives rather than other starting material.

### References:

1. Mayuri A. Board,;Manoj N. Bhoi,; Neelam P. Prajapati and Hitesh D. Patel, *J. Synthetic Communications*, April 2014; 44; 07, 897-922.
2. Rehn, S; Bergman, J; Stensland, B. *Eur.J.Org.Chem.* 2004, 413-418.
3. Xie, Y.M.; Yao, Y.Q.; Sun, H.B.; Liu, J.; Kang, T.R. *molecules* 2011, 16, 8745-8757.
4. Chen, G.; Yang, J.; Gao, S.; Li, S.; Di, Y.; Chang, Y.; Lu, Y.; Hao, X. *J.Mol.Divers.* 2012, 16, 151-156.
5. Abdelhamid, I.A.; Mohameda, M.H.; Abdelmoniem, A.M.; Ghazlan, S.A.S. *Tetrahedron* 2009, 65, 10069-10073.
6. Kurosh, R.M.; Leila, Y.M., *Tetrahedron*, 2011, 67, 5693-5699.
7. Ji, S.-J.; Xu, X.-P.; Zhao, K.; Zhu, S.-L.; Shi, D.-Q. *Synthesis*, 2010, 1793-1803.
8. K.C.Majumdar; S Ponra and R.K.Nandi; *Tetrahedron Lett.* 2012, 53, 1732-1737.
9. K.R. Moghadam and L.Y. Mirri; *J.Fluorine Chem.* 2012, 135, 213-219.
10. Y.Sarrafi. K.Almohammadi; M.Sadafshahabi and Norozipooe, *Monatsh Chem.* 2012. DOI 10.1007/500706-012-07-20-7.
11. B.V.S. Reddy; N Rajeshwari, M.Sarangapani, Y.Prashanthi, R.J. Ganji and A.Addlagatha. *Bioorg. And Med. Chem. Lett.* 2012, 22, 2460-2463.
12. Mohammad Shahidul Islam; Assem Barkat; Abdullah Mohammed Al-Majid; Hazem A Ghabbou, Hoong-Kun-Fun; M. Rafiq Siddiqui; *Arabian Journal of Chemistry.* 2017; 10, 1; 1-9.
13. S.M.Medvedeva, A.L.Sabynin, K.B.Shaikhaliev, *Russian Chemical Bulletin*; 2014; 63, 12, 2693-2701.

## Bayesian Model for Ecological Balance of Environment

**Prof. Smt. Mangal Vijay Gaikwad**  
Dept of Mathematics  
Karmaveer Bhaurao Patil College,  
Urun-Islampur Tal- Walwa, Dist Sangli

### 1. Abstract

*The Bayesian beliefs for pollution control and maintaining the ecological balance of environment in the states of India, in particular case Maharashtra. We have to conserve the forests and rejuvenate the area under forests in states of India. The Bayesian Probability Theorem for likelihood functions of past experiences of forest Experts and their Opinions should be considered. The best suitable Bayesian Model is developed for environment and Bio-diversity co-existence in various states of India particularly with study of Maharashtra forest officers and forest Department in Maharashtra. For this, experts' opinion about the likelihood function  $P(\square/X)$  is decided by empirical survey. The Bayesian Belief (likely hood function)  $P(X/\square)$  is researched out. For this model here,  $\square$  is the population parameter. Average forest cover in Maharashtra by using Bayes' Theorem*

$$P(\square / X) = \frac{P(Q).P(X/\theta)}{\sum P(\theta).P(X/\theta)} \text{----- (1)}$$

### 2. Forest Area

#### Forest Area cover in Mahrashtra and India

The recorded thick forest cover in Maharashtra was 61939 km<sup>2</sup> in 2012 which was approximately 20.10% to the geographical area of Maharashtra. By the report of Forest Department of Maharashtra Government, forest cover increased from 43843 km<sup>2</sup> in 1995 to the 50682 km<sup>2</sup> in 2017. Change in forest cover is 6839 km<sup>2</sup> which is nearly increased as 15.59% (i.e. 16%). It is clear that, in 22 years the forest cover area has increased by 0.73% per year in Maharashtra. Current forest cover in Mahrashtra is not sufficient for the environment control and ecological balance with biodiversity.

As per recent Forest survey of India, total forest cover is 708273 km<sup>2</sup> which is 21.53% of total geographical area of India. Hence the Researcher wish to develop and design The Bayesian model for Ecological Balancing of Environment.

#### 3) Bayesian Model

Empirical enquiry and survey about the forest conservation of Maharashtra state is conducted by considering 36-Districts and nearly 10 Talukas of each district. The total number of Forest conservative officers is 360 (N=360) and sample design with sample number n = 100 forest conservation officers are considered using suitable statistical formula by systematic sampling. The opinions and likelihood for the average area cover under forest is collected by Mobile-Telephony Techniques. The priori probability for likelihood percent of forest covers is recorded as below.

<b>Opinion of forest cover ratio</b>	S	0.10	0.15	0.20	0.25	0.30	0.35
<b>Probability</b>	P(S)	0.05	0.15	0.20	0.30	0.20	0.10

This past model is developed by using Bayesian Theorem (1) and applying the simulation Monte Carlo method along with consulting the Binomial probability distribution table in consecutive four stages. In stage (1), out of 20 Talukas in north zone, 4 forest conservation officers are randomly selected and opinions are recorded. In stage (2) out of n = 16 forest officers, 3 forest officers are interviewed from west zone. In stage (3), out of 17 forest officers 5 officers are interviewed from South zone while in stage (4) out of 14 forest conservation officers 5 officers are enquired about the area under forest covers. This data is classified and finally conclusions are drawn. Here the researcher is producing the final and 4<sup>th</sup> table for drawing conclusion.

**Table Fourth Simulation Bayesian Likely hood table.**

Proportion under (S) forest	P (S) likelihood	P (X/S) Likelihood	P(S). P(X/S)	P(S/X) Bayesian probability
0.10	0.0201	0.078	0.0002	0.0015
0.15	0.0746	0.0352	0.0026	0.0197
<b>0.20</b>	<b>0.2627</b>	<b>0.0860</b>	<b>0.0226</b>	<b>0.1713</b>
<b>0.25</b>	<b>0.4067</b>	<b>0.1468</b>	<b>0.0597</b>	<b>0.4526</b>

<b>0.30</b>	<b>0.2143</b>	<b>0.1963</b>	<b>0.421</b>	<b>0.3193</b>
0.35	0.0216	0.2178	0.0047	0.0356
<b>Total</b>	<b>1.0000</b>	-	<b>0.1319</b>	<b>1.0000</b>

In above table gives the likelihood belief of  $X =$  no. of forest officers with  $S =$  proportion of forest cover for Ecological Model for forest conservation with environment control Bayesian belief model from formula (1).

#### (4) Conclusion

Applying the priori likelihood functions  $P(X/S)$  with proportion of area under forest ( $S$ ) according to opinion survey of Expert forest officers. The Bayesian Belief Model is developed for  $P(S/X)$ : The ecological Balance and Environment control with Biodiversity in State of Maharashtra by Forest conservation officer. Utilizing Bayes' Theorem along with simulation Techniques and consulting Binomial distribution.

The results are searched out. As the Area under forest should be covered (20% to 30%) with confidence 94.32% Bayesian Belief for Environment control and biodiversity along with Ecological Balance for state in India. The area under forest cover should be improved from 20.1% to 24.39% in Maharashtra state within 5 to 6 years period.

#### 5) Suggestions

Precautions to be taken for Growth of forest cover in Maharashtra State.

- 1) Fire protection measures in forest Area should be implemented.
- 2) Mining and excess of mining will be control.
- 3) Wood-cutting must be banned.
- 4) Wood-Cutting for house-use and should be stopped.
- 5) Timber woods should not be used for construction works or Housing constructions.

#### 6) References

- 1) Cornfield. I, (1966), A Bayesian tests of some classical hypothesis with applications is sequential clinical trials. Journal of the American statistical Association 61. 577-594.
- 2) Gelman. A (2008) Objections to Bayesian Statistics. Bayesian Analysis 3. 445-450
- 3) Gregory, P.C. (2001) A Bayesian revolution in spectral Analysis in A. Mohammad –Diafan (Ed). AIP. Conference proceeding (pp.557-568) Berlin. Germany springer.
- 4) Jackman S. (2009) Bayesian analysis for the social sciences. West sister, England wiley.
- 5) Kline, R.B. (2004) beyond significance testing, reforming data analysis in behavioral research. Washington D.C. American Psychological Association.
- 6) Kruschke, J.K. (2010a) Bayesian data analysis. Wiley Interdisciplinary Reviews. Cognitive science. I 658-676
- 7) Kruschke J.K. (2010b) what to believe: Bayesian methods for data analysis. Trends in cognitive sciences 14, 293-300.
- 8) Kruschke J.K. (2011b, August 1) Extra-sensory perception (ESP): Bayesian estimation approach to meta-analysis [Blogpost] Retrieved from <http://doingbayesian.dataanalysisblogpost.com/2011/08/extrasensory-perception-esp-barryestion.htm>.
- 9) R. Development Core, Team (2012) R A Language and environment for statistical computing Vienna, Austria :
- 10) Western is and Jackman. S (1994) Bayesian inference for comparative research. American political science Review 88 412-423

## Structural, electrical properties of Mg substituted Mn ferrite by sol-gel method

A.V. Mali, G. B. Dhake and R.S. Patil\*.

UG and PG Department of Chemistry, Yashwantrao Chavan  
College of Science, Karad.-415124 Maharashtra, India

### Abstract:

$Mg_{1-x}Mn_xFe_2O_4$  (where  $x=0.0, 0.25, 0.50, 0.75, 1.0$ ) ferrite nanoparticles were synthesized by sol-gel auto-combustion method. The thermal decomposition process was investigated by Thermo Gravimetric Analysis (TGA) and Differential Thermal Analysis (DTA) technique. The phase composition of the Magnesium substituted Manganese ferrite samples were characterized by powder X-ray diffraction analyses (XRD). The entire sample showed formation of cubic spinel symmetry. The DC conductivity studies of the samples reveal their semiconducting nature.

**Key words:** Sol-gel auto-combustion, TG-DTA.

Corresponding Author: R.S.Patil  
Email: rspatilorg@gmail.com

### 1. Introduction

Advanced novel materials are essential for the various applications, where as nanostructured materials have become essential for the advancement of science and technology. The manipulation of physical and chemical properties of the materials is one of the challenging needs in physics, chemistry and material sciences. The specific properties of the nanomaterials such as structural, electrical, optical, magnetic and electrochemical properties mainly depend upon their size and shapes. Therefore, the particle size and shape are known to be crucial parameters for the nanomaterials in novel applications.

Among the different categories of nanomaterials, transition mixed metal oxide based spinel type ferrites [ $MFe_2O_4$ ] are significant and stable interest in different fields [1]. It is well known that spinel ferrites are highly resistive materials; hence, they are used as microwave and magnetic devices [2]. However, now a day, these materials can be used in diverse applications by tuning their properties through modifying the particle size and shape, suitable substitution and formation of different compositions. Some of the recent applications of nanosized ferrites and their composite are in drug delivery systems [3], solar cells [4], isolation and purification of genomic DNAs [5], catalyst for oxidation of organic compounds [6], making cores of audio frequency and high frequency transformers, coils, chokes, permanent magnets, magneto-optical displays, microwave absorber [7], high density information storage [8] color imaging [9], electro-magnetic wave absorption etc.[10].

In the present investigation we have prepared  $Mg_{1-x}Mn_xFe_2O_4$  ferrites by sol-gel auto-combustion method and study of their structural and electrical properties were carried out.

### 2. Experimental

Polycrystalline powder of  $Mg_{1-x}Mn_xFe_2O_4$  was prepared by sol-gel auto-combustion method. The A.R. grade citric acid ( $C_6H_8O_7 \cdot H_2O$ ), magnesium nitrate [ $Mg(NO_3)_2 \cdot 6H_2O$ ] manganese nitrate [ $Mn(NO_3)_2 \cdot 4H_2O$ ] and ferric nitrate [ $Fe(NO_3)_3 \cdot 9H_2O$ ] were used as starting materials. The molar ratio of metal nitrates to citric acid was taken as 1:1. The metal nitrates were dissolved together in a minimum amount of double distilled water to get a clear solution. An aqueous solution of citric acid was mixed with metal nitrates solutions, and then ammonia solution was slowly added to adjust the pH at 9.5. The mixed solution was kept on to a hot plate and the solution is continuously stirred at 363K. During evaporation, the solution becomes viscous and finally converts into a very viscous brown gel. When all water molecules were evaporated from the mixture, the viscous gel begins to froth. After few minutes, the auto-ignition gets completed yielding the brown colored ash which is termed as precursor. The as-prepared precursors of the samples were heat treated separately at 973 K for 8h to get final product.

### 3. Results and Discussion

#### 3.1 Thermal analysis

The formation of spinel phase of ferrite as well as the analysis of TG-DTA data of  $x = 0.50$  was showed in Fig.1. The DTA curve showed at 373 K indicates the decomposition of adsorbed water in inner as well as outer surface of the crystals. The next exothermic peak at 673 K indicates the decomposition of organic matter and crystallization of spinel phase. Thus, the temperature recorded by TG-DTA for spinel formation is expected to be higher. It has been reported that the organic materials are removed completely only above 673 K from the precursor sample obtained from nitrate-citrate gelation method. Therefore, even though the decomposition was completed at 1273 K the material was further calcined at 1273 K, whereas crystalline spinel ferrites were formed confirmed by XRD data.

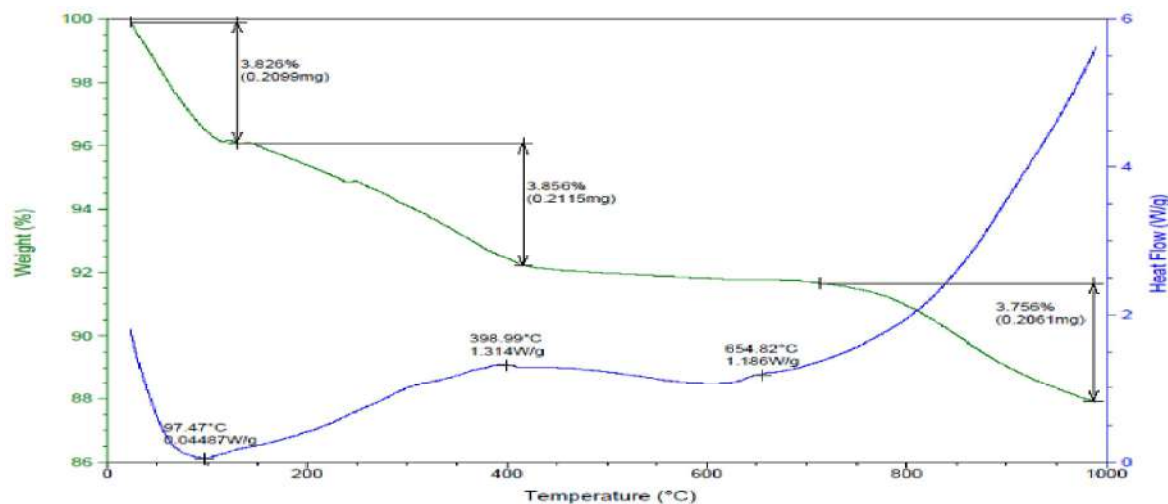

Fig.1. TG-DTA of  $Mg_{0.5}Mn_{0.5}Fe_2O_4$

### 3.2 X-ray diffraction (XRD) studies

Fig.2 shows the x-ray diffractograms of  $Mg_{1-x}Mn_xFe_2O_4$  with  $x = 0.0; 0.25; 0.50; 0.75; 1.0$  samples. It clearly indicate that the prepared sample contain cubic spinel structure only. The average crystallite size ( $D$ ) was lies in between 44 nm to 58 nm which was calculated by using the Scherer's formula [11] (Table 1).

$$D = 0.9\lambda / \beta \cos\theta$$

The close examinations of the XRD patterns (Fig.2) revealed that the crystallite size increases with increase in manganese content . The values of lattice constants were calculated by using XRD data for all the samples which are listed in Table 1. The X-ray density ( $\rho_x$ ) was calculated using the following relation and they are also included in Table 1.

$$\rho_x = 8M / Na^3$$

Where  $N$  = Avogadro's number ( $6.023 \times 10^{23}$  atom/mole)  $M$  = Molecular weight.  $a$  = lattice constants.

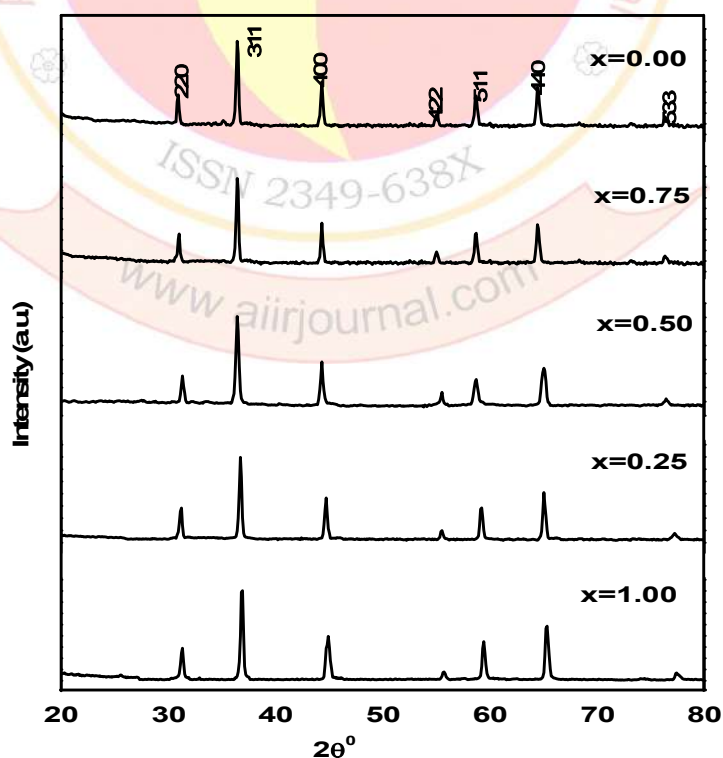
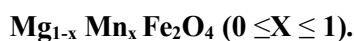

Fig.2. X-ray diffractograms of  $Mg_{1-x}Mn_xFe_2O_4$

Table. 1. Lattice constants, Crystallite size, X-ray density and physical density for



Sr. No.	Compound	Lattice Constants (Å)	Crystallite Size (nm)	X – ray density( $d_x$ ) $\text{g}/\text{cm}^3$	Physical density ( $d_B$ ) $\text{g}/\text{cm}^3$
1	x = 0.0	9.23	44.15	4.60	3.52
2	x = 0.25	9.26	46.26	4.64	3.88
3	x = 0.5	9.28	48.41	4.73	4.36
4	x = 0.75	9.31	53.34	5.10	4.53
5	x = 1.0	9.32	56.21	5.24	4.88

### 3.3 D.C. Electrical resistivity

The variation of DC resistivity for  $\text{Mg}_{1-x}\text{Mn}_x\text{Fe}_2\text{O}_4$  ferrites with temperature in the range of 373-673K is shown in Fig.3. The relation between resistivity and temperature may be expressed as [12].

$$\rho = \rho_0 \exp \left( \frac{E_a}{KT} \right),$$

where  $\rho$  is resistivity at temperature T,  $E_a$  the activation energy for electrical process, K is Boltzmann constant, T is temperature in K.

From these plots it is observed that the electrical resistivity of all the samples decreases with increasing temperature which shows a semiconductor behavior.

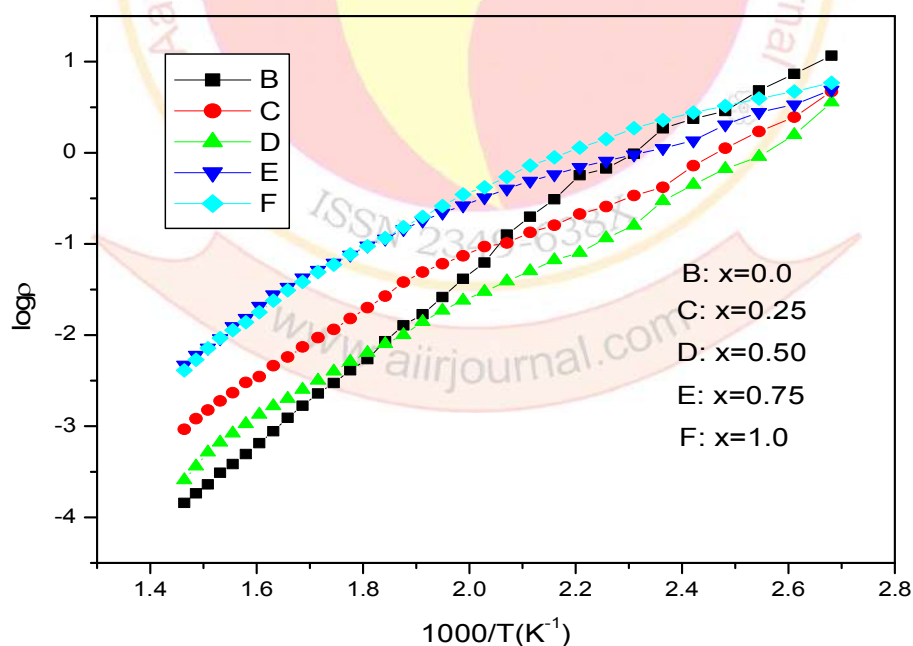

Fig.3. Variation of D.C. electrical resistivity with temperature for  $\text{Mg}_{1-x}\text{Mn}_x\text{Fe}_2\text{O}_4$  ( $x = 0.0; 0.25; 0.50; 0.75; 1.0$ ).

## 4. Conclusions

A series of magnesium substituted manganese ferrite were synthesized by the pH controlled sol-gel auto-combustion method. Their thermal analysis shows formation of the spinel phase at 1273K. The crystal structure of all samples are cubic spinel. The lattice parameter 'a' and X-ray density increases with increasing Mn content. The stoichiometry of the samples were matched with calculated one. The electrical resistivity of all the samples decreases with increasing temperature.

**Acknowledgements:**

All the authors thankfully acknowledgments to Head department of chemistry and Principal of the Yashwantrao Chavan College of Science, Karad for valuable co-operations.

**References:**

- [1] Mohammad Hassan Ramezan zadeh, Majid Seifi, Hoda Hekmatara, Mohammad Bagher Askari. Chinese Journal of Physics, Vol. 55, Issue. 4 (2017) 1319.
- [2] E.M.M. Ibrahim, Ahmed M. Abu-Dief, A. Elshafaie, A.M. Ahmed. Materials Chemistry and Physics, Vol. 192 (2017) 41.
- [3] M.A. Ahmed, Samiha T. et.al., Journal of Magnetism and Magnetic Materials, Vol. 331 (2013) 256.
- [4] Shazia Bano, Muhammad Afzal and Mustansar Mahmood Waraich. International Journal of Pharmaceutics, Vol. 513, Iss.1-2 ( 2016) 554.
- [5] Guangshuo Wang, Yingying Ma, Zhiyong Wei, Min Qi. Chemical Engineering Journal, Vol. 289 (2016)150.
- [6] L. Zhang, W.W. Zhong, S.S. Yu, S.X. Xue, Y.P. Liu, Z.G. Li, W.P. Chen. Journal of Alloys and Compounds, Vol. 560 (2013)177.
- [7] Haojie Geng, Zhongqing Yang, Li Zhang, Jingyu Ran, Yunfei Yan and Mingnv Guo. International Journal of Hydrogen Energy, Vol. 41, Iss. 40 (2016) 18282.
- [8] Is Fatimah .Journal of Advanced Research, Vol. 5, Iss. 6(2014)663.
- [9] Miklos Szavuly, Szilvio D. et.al. Journal of Molecular Catalysis A: Chemical, Vol. 393 (2014) 317.
- [10] M. Bharathiraja, R. Venkatachalam and N. Tiruvenkadam. Transportation Research Part D: Transport and Environment, Vol. 49 (2016) 291.
- [11] Vladimir Uvarov, Inna Popov. Materials Characterization, Vol. 85 (2013)111.
- [12] Erhan Eser, Hüseyin Koç., Physica B: Condensed Matter, Vol. 492 (2016) 7.

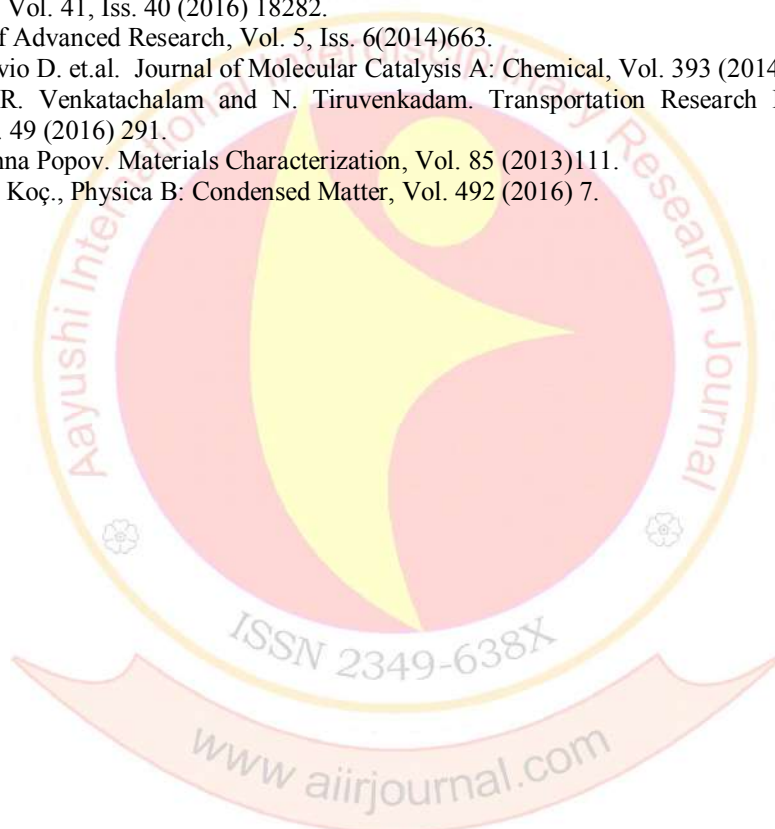

## The Cosmos & The Laws Of Physics

**D. B. Rane,**

Department of Physics, Br. Balasaheb Khardekar  
College, Vengurla Dist- Sindhudurg (M. S.)

### Abstract

*When we investigate the laws applicable to the cosmos we found that as the state of matter changes the law also changes. For massive bodies Newton's laws are applicable but in case of electromagnetic waves Maxwell's four equations are applicable. Also here I am going to investigate what is basic form energy or matter which is responsible for such type of behavior of the cosmos (Expansion, stagnant, collapse). This is the small survey of state of matter and the laws of physics applicable. We found that two well established theories having major contradiction with each other are based on same nature of law. Yes I am talking about law of Gravitation and Coulomb law of electrostatics. Force of*

*attraction between two given bodies is given by* 
$$F = \frac{GMm}{R^2}$$

where G is Universal Gravitational Constant

M = Mass of big body m = mass of small body R = Minimum distance between the two bodies

And the physics of electromagnetic waves is governed by a fundamental coulomb's law of electrostatics *i.e.*

$$F = \frac{KQq}{r^2}$$

**Keywords:** The matter, The energy, The Newtonian physics, Maxwell electrostatics, The universe, The cosmos, Einstein's theory of relativity.

### Introduction

While taking the survey of Newtonian physics, Maxwell's electrostatics, and Einstein's theory of Relativity and Basic Indian philosophies like Bhagwat Gita, Surya Sidhant, we may find many similarities among them. This is the initial step in that direction. When matter changes into charge particle, law of force also changes but the nature of law remains same. Basically the universe was in an extremely hot and dense state. The universe was in a singular state. The universe then expanded very rapidly and still continues to expand rapidly. As a result of expansion, the universe is cooling simultaneously. At this stage, Stephen Hawking says "My goal is simple. It is a complete understanding of the Universe, why it is as it is and why it exists at all."

### Previous work done

David J. Griffiths [1] describes that the stationary charge produces electric field and moving charge produces magnetic field. Thus time varying electric and magnetic fields is the electromagnetic wave propagating in some directions. Thus charge is the base of electromagnetic waves and of electromagnetic radiations. The electric field satisfies the Poisson's equation. According to Newtonian physics, J. V. Naralikar [2] states that mass of a body produces gravitational field around it. Gravitational field also satisfies Poisson's equation. Thus when this universe becomes matter dominated, Newtonian Physics holds good. But at early stage of the universe, the universe was micro wave and particle dominated and for that stage, electrostatics was applicable. According to Einstein's theory of relativity, Robert Resnick [3] states that charge is absolute and mass of a body is relative quantity. A. Z. Capria et al [4] describes that the whole electrostatics is governed by Maxwell's four equations. S. K. Srivastava [5] states that non-inertial frame of reference is equivalent to gravitational field. William Hayt Jr. [6] states that moving charge particle is responsible for the creation of the magnetic field.

### The Newtonian Cosmological Theory

The explanation of cosmos by different Scientists of 18, 19, & 20<sup>th</sup> century which includes mainly Galileo, Kopernicus, Kant, and whole philosophy is placed together by a great scientist Newton. It means this whole universe is governed by Newtonian physics, each and every thing which is taking place in this universe can be explained by Newton's Laws of Gravitation. Force of attraction between two given bodies is given by

$$F = \frac{GMm}{R^2}$$

where G is Universal Gravitational Constant

M = Mass of big body m = mass of small body R = Minimum distance between the two bodies

To explain this whole universe Physicist confirms some quantities which are required things to explain universe with different characteristics. It means we have in Physics primary, secondary, tertiary physical quantities which are required things for the explanation of the Universal activities. But all the



physical quantities are having dimensions of M L T. It means any physical quantity may be represented in terms of mass, length, & time. It suggests that there are only three fundamental physical quantities which can explain the whole Universe. But all these rules and principles of physics are applicable to matter dominated Universe.

### Big Bang Theory of George Gamow and Hayashi

We know that the matter is created from energy as stated in Big bang theory. This means at the early Universe stage everything was in the form of energy. The initial known form of energy is microwaves so this Universe is having microwave background. As the expansions this Universe took place temperature of this universe comes down from  $10^{13}$  K to  $10^{12}$  K and creation of energy packet like X-rays Y-rays, Particles, B-particles after that as further expansion took place temp. of universe. Steel decreased to  $10^{10}$  K and particles like proton, neutrons & electrons are created then atoms, molecules & matter planets, stars, black hole, Galaxies group of galaxies, clusters, super clusters & finally whole universe is created. If we look at this situation Newtonian physics is applicable to this whole Universe But if we go deep into the matter that is if we think about the electromagnetic waves from which this whole Universe is created. Newtonian physics fail to explain what is happening with the microwave. According to Newtonian physics material medium is required to propagate any wave. But in case of electromagnetic wave no material medium is required to propagate from one point to another point. At this initial stage Newtonian physics fail to explain these phenomena there are so many cosmological phenomena which cannot be explain on the basis of Newtonian Physics.

### Maxwell's Electrodynamics

The science of electromagnetic waves is develop by scientist like Coulomb, Faraday, Gauss, Ampere & finally by Maxwell. The outputs of Maxwell's electrodynamics is electromagnetic waves can travel through vacuum with constant speed  $C = 3 \times 10^8$  m/s which is same in all direction. According Newtonian physics velocity of light is non-uniform cannot passed through vacuum and velocity will be different for different observer this is complete contradiction with Maxwell thoughts

Then in early 20<sup>th</sup> Century Einstein put forward the special theory of relativity and general theory of relativity which can explain Maxwell Electrodynamics and Newtonian Physics simultaneously. This theory state that Maxwell theory is confirmed theory and Newtonian physics is Low velocity physics therefore it has to be moderated. Einstein develop the special theory of relativity for uniform velocity and general theory for non-uniform velocity thus Einstein general theory of relativity is most successful theory of the time which could explain all the universal phenomena. If we look at the basic thing here that the physics of matter is govern by

the fundamental law of force of gravitation  $F = \frac{GMm}{R^2}$  and the physics of electromagnetic waves is govern

by a fundamental coulombs law of electrodynamics  $F = \frac{KQq}{r^2}$ . The nature of law remain same only the mass

is replaced by charge. Further if we look at the theory of relativity we found that absoluteness of space & time goes off and absoluteness of velocity of light is generated again absoluteness of mass goes off and absoluteness charge is generated. This is happening when we travel from M is very large to M is very low (rest mass of electromagnetic wave photon) and speed is charging from V very low compare to C, the highest speed of the universe as stated in the theory of relativity.

Again according to Big Bang theory this Universe is now expanding it will be stagnant at some stage and it starts collapsing. Thus according to this theory Universe is created from Zero size & infinite mass density after big bang, it will go on expanding and it will become stagnate & then it will collapse. The time required for expansion and collapse will be same. Everything in this Universe is having speed in anticlockwise direction & speed is responsible for the expansion of this Universe & gravitation is responsible for the collapse of this Universe.

### Conclusion:

According to Newtonian Physics, mass is responsible for the gravitational field. According to Maxwell's electrodynamics, charge is responsible for the creation of electromagnetic field. If we look at the nature of laws, we find that in both the cases it is perfectly similar. Thus whatever may be the state of matter, the nature of laws remain the same.

### References:

- [1] David J. Griffiths, "Introduction to Electrodynamics", Prentice Hall of India, Third Edition
- [2] J. V. Naralikar, "Introduction to Cosmology", Cambridge University Press, Third Edition
- [3] Robert Resnick, "Introduction to Special Relativity", Wiley Student Edition
- [4] A. Z. Capria et al., "Introduction to Electrodynamics", Narosa Publishing House
- [5] S. K. Srivastava, "General Relativity and Cosmology", Prentice Hall of India
- [6] William Hayt Jr., "Engineering Electrodynamics", Tata Magraw Hill Publication.

## Theoretical basis of Soil Analysis

J K Dawle\*, A S Bondge<sup>1</sup>, K I Momin<sup>2</sup>, V B Suryawanshi<sup>3</sup>

\*Head, Department of Chemistry, M M Nilanga.

1. Department of Chemistry, S M Shirur Anantpal.

2. Department of Chemistry, R S M Latur.

3. Department of Chemistry, K M C Khopoli.

### Abstracts

*The analysis of nutrient is done in order to measure the nutrient that is present in the soil and it provides all the necessary information that is required in order to set the target of nutrient application. It also allows the detection and monitoring of the changes in the parameters of soil. The result depends on quality of soil samples. In this paper, the soil samples collected from horticulture spot, lakeside, agriculture area are studied. For the estimation of total Nitrogen, available Phosphorus, available potassium and exchangeable Calcium and Magnesium the methods used are Kjeldahl method, Bray's or Olsen's method, Flame photometric method and EDTA titration method respectively.*

Keywords: kjeldahl method, topsoil, fertilizer, flame photometric method, Bray's method, EDTA, soil sampling, extractant.

### Introduction

Nitrogen (N), potassium(K) and Phosphorus (P) are very essential for plant growth and also for the strengthening of reproductive parts, activation of enzymes and carbohydrate metabolism<sup>1</sup>. Nitrogen and Phosphorous are not available to the plants directly. They are incorporated in the organic material. Potassium (K) is present in elemental form, exchangeable form or as a part of mineral lattices. Calcium (Ca) and Magnesium (Mg) interfere in soil activity as well as activate a number of plant enzyme systems. The deficiency of any of these elements has retarding effect on the growth of plant.

1.1 Nitrogen Nitrogen occurs in several forms: Nitrate (NO<sub>3</sub><sup>-</sup>) and nitrite(NO<sub>2</sub><sup>-</sup>) anions, ammonium(NH<sub>4</sub><sup>+</sup>) and organic compounds. For high production, the application of N fertilizers can be done. This can be determined after the estimation of soil Nitrogen content. If the soil Nitrogen content is low, the application of N fertilizers becomes indispensable. Adequate supply of this element is associated with the plant growth and the deep green plant color.

The excess of this element can delay the crop maturity and prolong the growth period. The soil which is deficient in Nitrogen has stunted plant growth and they show signs of chlorosis too. There should be a proper quantity and proportion of soluble N which can be absorbed by the crop. This quantity is influenced by some local site factors like rooting habits of crop, removal of nitrate by leaching, the status of moisture in that part of root zone where the Nitrogen resides and presence or absence of the residues of crop.

1.2 Phosphorus Phosphorus occurs in soil in both organic and inorganic form<sup>6</sup>. The inorganic form is more important for the crop nutrition. Most of the P is absorbed by the plants as HPO<sub>4</sub><sup>-</sup> and H<sub>2</sub>PO<sub>4</sub><sup>-</sup> ions or soluble organic phosphates. availability of Phosphorus in soil is very variable because it depends on the mineral soil composition, organic materials and its rate of decomposition, local climatic conditions and the morphological properties of soil. The supply of P at the early vegetative growth phase strengthens its reproductive parts and formation of seeds. It can also hasten the maturity of plant and it is said to improve the resistance of certain fruits, vegetables and forages from disease. Its deficiency will lead to discoloration of older leaves and leaf edges.

1.3 Calcium It is present in the soil either as soluble Ca<sup>2+</sup> on the base complex or as free Calcium carbonate (CaCO<sub>3</sub>). In temperate soil it is present in abundance but it is absent in highly weathered tropical soils. It has a double role in the fertility of soil. It acts as plant nutrient at the same level as N, P and Mg as well as a pH regulator.

1.4 Magnesium It is the constituent of chlorophyll molecule, related to the metabolism of Phosphorus. It also activates number of plant enzymes. It is absorbed by the plant roots as Mg<sup>++</sup> ion. If the soil has deficiency of Mg then the plant grown in such soil will become pale yellow and then turns brown and necrotic.

1.5 Potassium It is present in the soil in different forms. K in the soil solution which is in equilibrium with exchangeable K<sup>+</sup> is difficult to distinguish from it, the exchangeable K<sup>+</sup> that is affected by the content of clay, mineral decomposition intensity and the fertilizer's quantity is also a form of Potassium in soil. The requirement of plant for K is high relatively because plants absorb it in higher amount than other nutrient. The deficiency of K leads to Chlorosis or necrosis.

### Experimental Section

1.6 Sites used for soil sample collection: all the soil samples were collected from different sites. Four types of soil samples were collected.

A.) soil sample from horticulture spot. B.) soil sample from lake side. C.) soil sample from Mountain. D.) soil sample from agricultural area.

1.7 Soil sampling: The top soil samples were taken from 0-10 cm of depth at four equidistant positions in each plot. When the sampling was done, the surface of soil in all plots was dry.

1.8 Estimation of soil nutrient:

A. Total nitrogen is estimated by kjeldahl method

B. Available Phosphorus is estimated by two methods: Bray's method which is the best method for acidic soils and olsen's method which is best for neutral and alkaline soils.

C. Available Potassium is estimated by Flame photometric method

D. Exchangeable Calcium and Magnesium is usually determined in the neutral ammonium acetate extract of soil. The extraction is carried out by shaking the soil and the extractant of mixture is followed by either filtration or centrifugation. Then the determination of Ca and Mg is done either by EDTA titration method or by the atomic absorption spectrophotometer after removal of organic matter and ammonium acetate

## Conclusion

Nutrient analysis is the measurement of nutrients present in the soil which is removed from the soil using an extracting solution. The nutrient analysis of soil will provide the necessary information to set the target of nutrient application. **It is then used to set up the target of nutrient application which is then used to calculate the rate of manure and fertilizer application.** The results of tests from regular field sampling will allow the detection and monitoring of the changes in soil parameters (pH, nutrients, salinity) with the time.

It is must for the soil analysis results to be interpreted within the context of the expected yield response for the crop which is to be grown under the specific management and environmental conditions. The results depend on the quality of soil samples collected and also the strategy of sampling that is used. If the samples are poor it will lead to inaccurate nutrient recommendations.

## Acknowledgement

Author are thankful to Principal, Librarian of M M Nilnaga, S M Shirur Anantpal, R S M Latur and K M C C Khopoli.

## References

- [1]. Hundal, H.S., Rajkumar, Dhanwindar Singh and Machandra, J.S. (2006) Available nutrient and heavy metal status of soils of Punjab, North-west India. *Journal of the Indian Society of Soil Science*, 54 : 50-56.
- [2]. Jackson, M. L. (1973) *Soil Chemical analysis*, Prentice Hall of India Private Ltd. New Delhi.
- [3]. Jibhakate, S.B., Raut, M.M., Bhende, S.N. and Kharche, V.K. (2009) Micronutrient status of soils of Katol tahasil in Nagpur district and their relationship with some soil properties. *Journal of Soils and Crops*, 19 : 143-146.
- [4]. Kadao, S.H., Prasad J. and Gajbhiye, K. S. (2002) Micronutrients status in Banana growing soils of Wardha district of Maharashtra. *Journal of Maharashtra Agricultural University*, 27 : 117-119.
- [5]. Lindsay, W.L. and Norvell, W. A. (1978) Development of DTPA soil test for Zn, Fe, Mn and Cu. *Soil Science Society of America Journal*, 42 : 421-428.
- [6]. Mali, C.V. and Raut, P.D. (2001) Available sulphur and physico-chemical characteristics of oil seed dominated area of Latur district. *Journal of Maharashtra Agricultural University*, 26 : 117-118.
- [7]. Meena, H.B., Sharma, R.P. and Rawat, U.S. (2006) Status of macro and micronutrients in some soils of Tonk district of Rajasthan. *Journal of the Indian Society of Soil Science*, 54 : 508-512.
- [8]. Murthy, R.K. and Murthy, C.A. S. (2005) Distribution of some available micronutrients in black and red soils of Karnataka. *Mysore Journal of Agricultural Science*, 39 : 57-63.
- [9]. Ram, J., Singh, S.P. and Gopal, R. (1999) Available micronutrient in relation to soil properties in the soils of Bundelkhand. *Journal of Maharashtra Agricultural University*, 24 : 112-114.
- [10]. Ramamoorthy, B. and Bajaj, J. C. (1969) Available N, P and K status of Indian soils. *Fertilizer News*, 14 : 24-26.
- [11]. Sharma, R.P., Megh Singh and Sharma, J.P. (2003) Correlation studies on micronutrients vis-à-vis soil properties in some soils of Nagpur district in semi-arid region of Rajasthan *Journal of the Indian Society of Soil Science*, 51 : 522-527.
- [12]. Shinde Y. R. (2007) Physico-chemical properties and nutrient availability of soils of Udgir and Deoni tahsils of Latur district M.Sc. (Agri.) thesis submitted to MKV, Parbhani.
- [13]. Vijaya kumar M., Lakshmi, G.V. and Madhuvani, P. (2013) appraisal of soil fertility status in salt affected soils of ongole division, Prakasam district of Andhra Pradesh. *Journal of the Indian Society of Soil Science*, 61 : 333-340.
- [14]. Waikar, S.L., Malewar, G.U. and More, S.D. (2004). Elemental composition of Humic and Fulvic acid in soils of Marathwada region of Maharashtra. *Journal of Maharashtra Agricultural University*, 29 : 127-129.
- [15]. Yadav, R.L. and Meena, M.C. (2009) Available micronutrient status and their relationship with soil properties of Degana soil series of Rajasthan. *Journal of the Indian Society of Soil Science*, 57 : 90-92

**Photoelectrochemical studies on chemically deposited Cd<sub>1-x</sub>Pb<sub>x</sub>Se thin film****R. M. Ovhal, R.A. Pawar<sup>b</sup> and K.D. Gaikwad<sup>a</sup>**Walchand College of Arts and Science, Yadav  
College, Vadgaon, Sangmeshwar College<sup>a</sup>  
Solapur - 413006. Maharashtra, India**Abstract:**

Polycrystalline Cd<sub>1-x</sub>Pb<sub>x</sub>Se Semiconductor thin films were obtained by relatively simple chemical bath deposition method using cadmium sulphate (octahydrate), lead acetate, triethanolamine, ammonium hydroxide and sodium selenosulphate as precursor sources in an aqueous alkaline medium at 50±2<sup>o</sup>C temperature. Various preparative conditions of Cd<sub>1-x</sub>Pb<sub>x</sub>Se thin films are outlined. The grown films were found to be uniform, well adherent, and brown in colour. The films were studied using X-ray diffraction (XRD), scanning electron microscopy (SEM), optical absorption, electrical conductivity properties and photoelectrical characterization. Photoelectrical characterization of the Cd<sub>1-x</sub>Pb<sub>x</sub>Se thin film photoelectrode was carried out by studying current-voltage in dark, capacitance-voltage in dark. Fill factor, efficiency, I<sub>sc</sub>, V<sub>oc</sub>, junction ideality factor were found to be maximum for composition x=0.3. The study of power output characteristics showed open circuit voltage (V<sub>oc</sub>=275 mV), short circuit current (I<sub>sc</sub>=412 μA/cm<sup>2</sup>), fill factor (ff=42.19%), efficiency (η=1.585%).

**Keywords:**

Chalcogenides, semiconductivity, scanning electron microscopy, electrochemical properties.

**Introduction:**

Thin films of semiconductor play a central role in the development of modern technology, mainly in novel optical and electronic devices [1-3]. Considerable interest has been shown in the synthesis of semiconducting thin films for photoelectrochemical solar cell [4]. Among various semiconducting materials solid solutions of cadmium selenide thin films has several unique properties like direct band gap matchable with solar spectrum, high absorption coefficient in the visible and infrared region, good electrical properties and increased capability in obtaining adjustable n-or p-type conductivity by doping, that make them very promising in semiconducting devices, photovoltaic's, optoelectronic devices, radiation detectors, laser materials, thermoelectric devices, solar energy converters, sensors, etc. [5-7]. Perhaps, the Photoelectrochemical solar cell for low cost energy conversion has lead to an extensive research in the field novel and suitable thin film semiconductor materials [8-10].

The opto-electrical characteristics of the deposited materials often depend on the deposition technique used. Chemical bath deposition method has overriding advantages over other techniques, such as relatively used at low temperature, cheap instruments, convenience in handling and easiness in composition control making it very useful for the large scale and environmentally benign synthesis of materials [11-13].

Enormous research has been done on the production of low cost energy conversion of photoelectrochemical solar cell using suitable thin film semiconductor materials. Isoelectronic alloys of II-VI compounds such as CdZnSe, CdZnS, CdZnTe have been studied extensively in electronic and optical devices with major emphasis related to photoelectrochemical solar cell performance [14-16]. However photoelectrochemical performance of non-isoelectronic alloys of II-VI compounds, like CdPbSe thin films has been least studied so far. Therefore in the present investigation attempts are made to deposition of Cd<sub>1-x</sub>Pb<sub>x</sub>Se thin films by chemical bath deposition method. The structural, morphological, compositional, opto-electrical properties of deposited thin films with its photoelectrochemical solar cell performance are also reported.

**2. Experimental****2.1 Preparation of Cd<sub>1-x</sub>Pb<sub>x</sub>Se photoelectrodes**

Polycrystalline Cd<sub>1-x</sub>Pb<sub>x</sub>Se thin films photoelectrode samples with x=0 to x=1 have been obtained on both glass and stainless steel substrates. A simple and inexpensive scabale chemical bath deposition process was used for this purpose [17,18]. Equimolar cadmium sulphate octahydrate, lead acetate and sodium selenosulphate solution were used as the basic source materials. The deposition was carried out at pH value around 10.50 and the deposition temperature was controlled to 50±2<sup>o</sup>C. The cleaned glass and stainless steel substrates were attached to a specially designed substrate holder and were kept rotating at a speed of 70±2 rpm in order to achieve a continuous mechanical stirring of the reacting ions. The deposition time selected was 120 minutes. After 120 minutes the samples were detached from the substrate holder and preserved in a dark dessicator.

**2.2 Photoelectrochemical characterization**

The samples deposited on the stainless steel substrate were employed for the fabrication of a photoelectrochemical cell. In the present investigation, photoelectrochemical cell was fabricated using Cd<sub>1-x</sub>Pb<sub>x</sub>Se thin films as photoanode, a sulphide / polysulphide redox couple and sensitized graphite rod were used as electrolyte and counter electrode, respectively. The whole assembly was set in a corning glass cuvette

having 'H' shape was used to form the cell. An electrolyte solution offers an advantage of stabilization against photoelectrode dissolution [19,20].

In order to characterize the PEC cell the electrical properties of PEC cell were examined to know about the charge transfer mechanism occurring across electrode-electrolyte interface. These properties include I-V, C-V characteristics in dark, measurements of built-in-potential and power output characteristics. A helical potentiometer (10 turn, 1 k $\Omega$ ) was used to vary the voltage across the junction and the current flowing through the junction was measured with a sensitive Hewlett-Packard 6.5 digital current meter. The same circuit was used to measure the capacitance of the junction. For the determination of barrier height, reverse saturation current at different temperatures were recorded. The power output curve for various cell configurations were recorded under constant illumination intensity of 30mW/cm<sup>2</sup>. The illumination intensity was measured by Aplab (5011-S) luxmeter. Optical absorption, X-ray diffraction and microscope studies were performed on these film structures to support the photoelectrochemical performance.

### 3. Results and discussion

When a semiconductor photoelectrode surface is illuminated by light of photon energy greater than the optical gap of a semiconductor, excess carriers are generated that are separated at the space charge region. For n-type material, the electrons move deep into the bulk while, holes move to the surface of semiconductor, causing redox reaction to occur [21,22,29]. The charge separation process result in a counter field which is higher at the open circuit condition called the "open circuit voltage", which acts as a driving force for the electrons to move from the semiconductor to the counter electrode, where as the electrolyte captures the holes [2,23,24]. The current-voltage relation with a photoelectrode of varying composition parameter, x has been studied.

In an electrode/electrolyte system, the nature of the charge transfer reaction has been understood from the Butler-Volmer relation [25], and the magnitude of the symmetry factor  $\beta$  decides the nature of the junction formed at the interface. In our case, the observed magnitude of  $\beta$  is greater than 0.5, which suggests that the electrode/electrolyte interface formed is of the rectifying type [26] and that the junction is analogous to a Schottky barrier junction. The junction ideality factor, which is a measure of the quality of the junction, has been determined from the variation of  $\log I$  versus  $V$ , as shown in Figure 1. It has been seen that the recombination mechanism is dominant at the interface, as it is clear from the values of the junction ideality factor  $n_d$  in the dark, given in Table 1. A smaller value of  $n_d$  for a cell formed with a photoelectrode of composition  $x=0.3$  was indicative of comparatively fewer recombination centers at the interface [27]. The barrier height  $\Phi_B$  of the cells was determined from the temperature dependence of the reverse saturation current. The variation of  $\log (I_0/T^2)$  versus  $1/T$  is shown in Figure 2. It seems that the plot exhibits two distinguishable regions. The barrier height was calculated from the linear region of this plot and the values are listed in Table 1. At higher temperature, variation is nonlinear and could be attributed to the Pool-Frenkel type conduction mechanism [28].

The power output curves have been obtained for various cell configurations and are represented in Figure 3. The cell parameters, namely, short circuit current ( $I_{sc}$ ), open circuit voltage ( $V_{oc}$ ), efficiency ( $\eta\%$ ) and fill factor ( $ff\%$ ), have been determined. It has been observed that the short circuit current and the open circuit voltage was enhanced significantly for composition  $x=0.3$ .

The quality factor of the junction under the lighted condition has been determined from the photoresponse measurements. Values of  $n_L$  for various cell configurations are listed in Table 1. The performance of a photoelectrochemical cell was found to be improved and was optimum for the value of composition parameter  $x=0.3$ . We attribute to the improvement of the increased short circuit current of typical cell. The increase in short circuit current was due to the increased absorption and decreased band gap and series resistance of the photoelectrode material. Such observations were also reported by Hankare [16], Mahapatra [19] and Deshmukh [8] for mixed materials.

An important parameter of a photoelectrochemical cell called the flat band potential,  $V_{fb}$ , is determined from the voltage dependence of a space charge layer capacitance. Mott-Schottky plots have been constructed for a few typical cell configurations and the flat band potentials have been determined. The variations of the  $1/C^2$  with the electrode potential (versus SCE) for a few typical cells are represented in Figure 4. The value of flat band potential was higher for  $x=0.3$ .

The observed improvement in the solar cell performance understood well from the structural and microscopic observations of the photoelectrode material. Polycrystalline nature of samples with cubic and hexagonal phases was confirmed by XRD studies. The grain size for the various compositions has been determined and was found to increase as x increases. The increase in grain size has also been reported by Deshmukh [8], Hankare [26] and Zhu [27]. According to them, the increased grain size was due to the

relatively larger size of the hexagonal CdSe phases. They also point out that the smaller grains are due to a mixture of cubic and hexagonal phases.

The microscopic studies showed a mesh-like structure overgrown on the uniformly distributed grains of CdSe. This structure may be due to the multiple nucleations of PbSe molecules on already grown CdSe, as pointed out by Bhuse and Hankare [16]. The appearance of this extended growth was as shown in Figure 5. This has been further correlated to the XRD observations indicating the increase in hexagonality with composition  $x$ .

Thus the effect of grain boundary improvement will reduce the grain boundary carrier scattering and thereby the series resistance of a PEC cell, which was mainly due to the photoelectrode resistance. Furthermore, the increased absorption and decreased band gap also help to enhance the short circuit current of cell causing higher power conversion efficiency.

### Conclusions:

1. Good quality  $Cd_{1-x}Pb_xSe$  thin films photoelectrodes were synthesized by chemical bath deposition method.
2. Photoelectrochemical Cell conversion efficiency was enhanced to 1.585% for the composition  $x=0.3$ .
3. Fill factor, Open circuit voltage ( $V_{oc}$ ), Short circuit current ( $I_{sc}$ ), Junction ideality factor were found to be maximum for composition  $x=0.3$ .

### References:

1. M.S. Lee, I.C. Cheon, Y.I. Kim, Bull. Korean. Chem. Soc. 24 [2003] 1155.
2. D. Wei, G. Amaratunga, Int. J. Electrochem. Sci. 2 [2007] 897.
3. X. Mathew, A. Bansal, J. A. Turner, R. Dhere, N.R. Mathews, P.J. Sebastian, J. New. Mater. Electrochem. Sys. 5 (2002) 149.
4. P.A. Chate, P.P. Hankare, D.J. Sathe, J. Alloys. & Compounds., 505 (2010) 140.
5. C.D. Lokhande, Eun-Ho Lee, Kwang-Deog Jung, Oh-Shim Joo, Mats. Chem. Phys., 93 (2005) 399.
6. V. Sholin, A. J. Breeze, Y. Sahoo, D. Reddy, S. A. Carter, Sol. Energy Mater. Sol. Cells., 92 (2008) 1706.
7. V.M. Bhuse, P.P. Hankare, S. Sonandkar, Mats. Chem. Phys., 101 (2007) 303.
8. G. S. Shahane, L.P. Deshmukh, Mat. Chem. Phys., 70 (2001) 112.
9. S. D. Chavan, R. S. Mane, W. Lee, S. Senthilasar, S. Ham, J. Lee, S. Lee, Electrochim. Acta., 54 (2009) 3169.
10. J. J. Harris, A. J. Crocker, Thin Solid Films., 17 (1973) 129.
11. S. Ham, S. Jeon, U. Lee, K. Paeng, N. Myung, Bull. Korean Chem. Soc., 29 (2008) 939.
12. V. M. Nikale, C. H. Bhosale, Sol. Energy Mater. Sol. Cells., 82 (2004) 3.
13. R. B. Kale, S. D. Sartale, B. K. Chougule, C. D. Lokhasnde, Semicond. Sci. Technol., 19 (2004) 980.
14. J. P. Kloock, Y. G. Mourzina, Y. Ermolenko, T. Doll, J. Schubert, M. J. Schoning, Sensors., 4 (2004) 156.
15. S.D. Delekar, M.K. Patil, B.V. Jadhav, K.R. Sanadi, P.P. Hankare, Solar Energy., 84 (2010) 394.
16. P.P. Hankare, V.M. Bhuse, K.M. Garadkar, S.D. Delekar, I.S. Mulla, Semicond. Sci. Technol., 19 (2004) 70.
17. A. Feitosaz, M. Miranday, J. Sasakiy, M. Ara'ujo-Silvaz, Braz. J. Phys., 34(2004) 656.
18. I. C. Ndukwe, Sol. Ener. Mater. Sol. Cells., 40 (1996) 123.
19. P. Mahapatra, A. Dubey, Sol. Ener. Mater. Sol. Cells., 32 (1994) 29.
20. A. B. Ellis, S.W. Kaiser, M. S. Wrighton, J. Am. Chem. Soc., 98 (1976) 1635.
21. H. Gerischer, in "Topics in Applied Physics", Solar Energy Conversion, Springer, (Eds.) B.O. Seraphin, Heidelberg 31 (1979) 115.
22. A. Aruchami, G. Aravamudam, G. V. SubbaRao, Bull. Mater. Sci., 4 (1982) 483.
23. J. O. M. Bockris, A. K. Reddy, in "Modern Electrochemistry", Vol-2 (Eds.), Plenum Press, New York, 1973.
24. L. L. Kazmerski, M. S. Ayyagari, A. Sanborn, J. Appl. Phys., 46 (1975) 4865.
25. X. Mathew, A. Bansal, J. A. Turner, R. Dhere, N. R. Mathews, P. J. Sebastian, J. New Mater. Electrochem. Syst., 5 (2002) 149.
26. P. P. Hankare, V. M. Bhuse, S. D. Delekar, K. M. Garadkar, P. R. Bhagat, Semicond. Sci. Tech., 192 (2004) 277.
27. J. Zhu, X. Liao, J. Wang, H. Y. Chen, Mater. Res. Bull., 36 (2001) 1169.
28. Singh R.S., Bhushan S, Singh S.K. and Deo S.R., Digest journal of Nanomaterials and Biostructures, 2(2011)6.
29. Iqbal S. Nazi, Iman H. Khandyar, Hanaa I. Mohammad, International journal of Application or Innovations in Engineering Management, 2(2013)556.

**Table 1: PEC cell performance parameters of Cd<sub>1-x</sub>Pb<sub>x</sub>Se photoelectrode**

Composition (x)	V <sub>fb</sub> (V)	φ <sub>B</sub> (eV)	V <sub>oc</sub> (mV)	I <sub>sc</sub> (μA/cm <sup>2</sup> )	η %	ff %	R <sub>sh</sub> Ω	R <sub>s</sub> kΩ	n <sub>a</sub>	n <sub>L</sub>
CdSe	-0.425	0.448	150	333	0.927	39.88	570	2.91	5.68	8.3
(CdSe) <sub>0.9</sub> (PbSe) <sub>0.1</sub>	-0.565	0.465	225	380	1.365	41.89	496	2.45	5.61	4.2
(CdSe) <sub>0.7</sub> (PbSe) <sub>0.3</sub>	-0.716	0.483	275	412	1.585	42.19	457	1.91	5.55	1.8
(CdSe) <sub>0.5</sub> (PbSe) <sub>0.5</sub>	-0.468	0.429	200	365	1.180	43.49	492	2.25	5.65	3.4
(CdSe) <sub>0.3</sub> (PbSe) <sub>0.7</sub>	-0.425	0.359	165	283	0.787	45.23	523	2.53	5.71	4.9
(CdSe) <sub>0.1</sub> (PbSe) <sub>0.9</sub>	-0.410	0.324	137	210	0.539	47.30	543	2.72	5.76	6.1

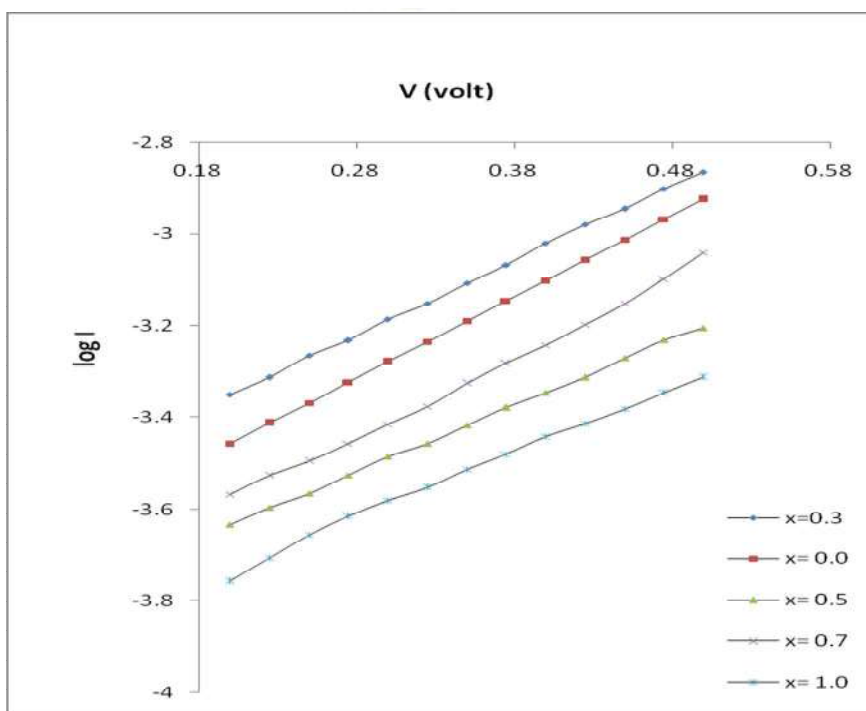

Figure 1. Plot of log I vs. voltage of PEC cell with different Cd<sub>1-x</sub>Pb<sub>x</sub>Se photoelectrode material

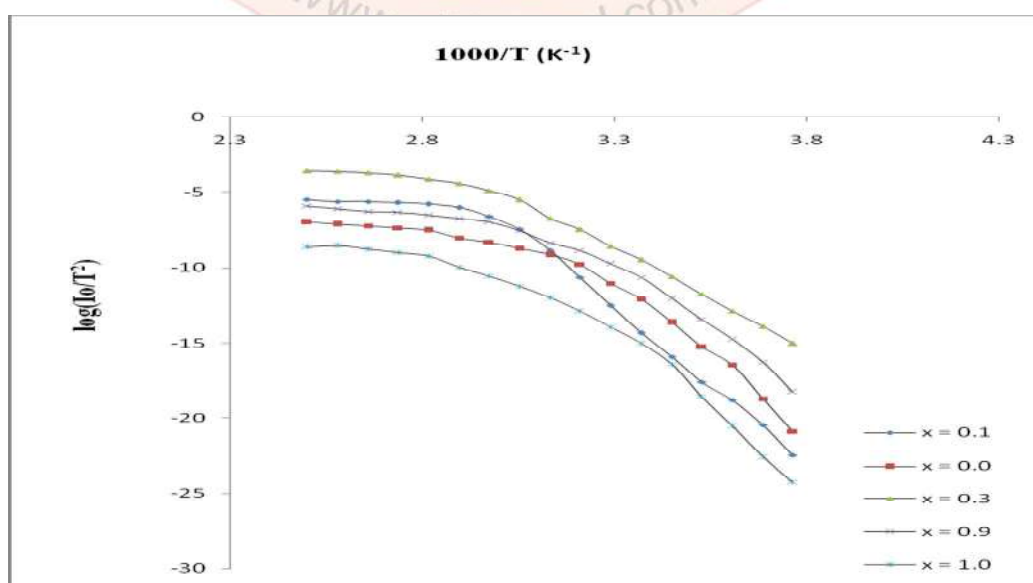

Figure 2. Variation of log (I<sub>0</sub>/T<sup>2</sup>) vs 1000/T for Cd<sub>1-x</sub>Pb<sub>x</sub>Se photoelectrode.

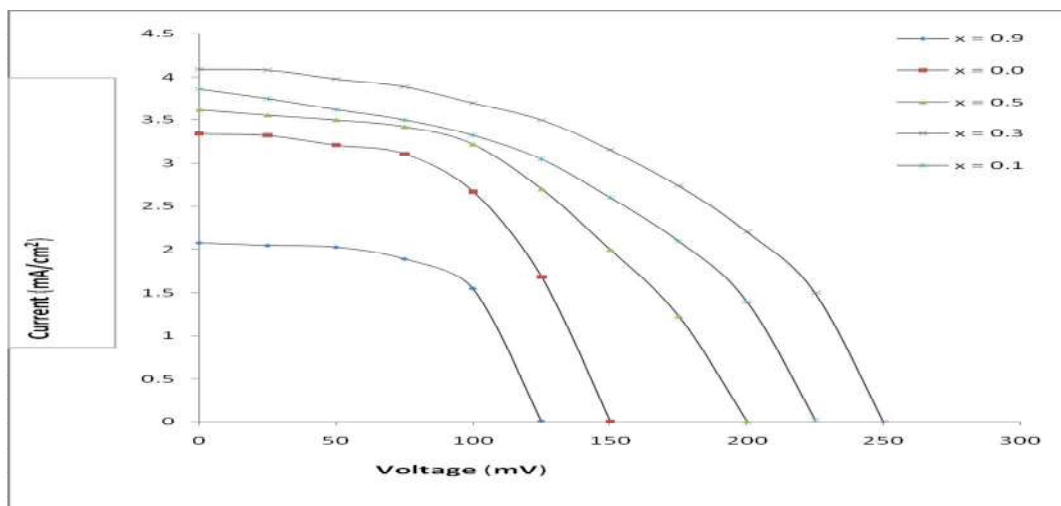

Figure 3. Power output curves for Cd<sub>1-x</sub>Pb<sub>x</sub>Sephotoelectrode

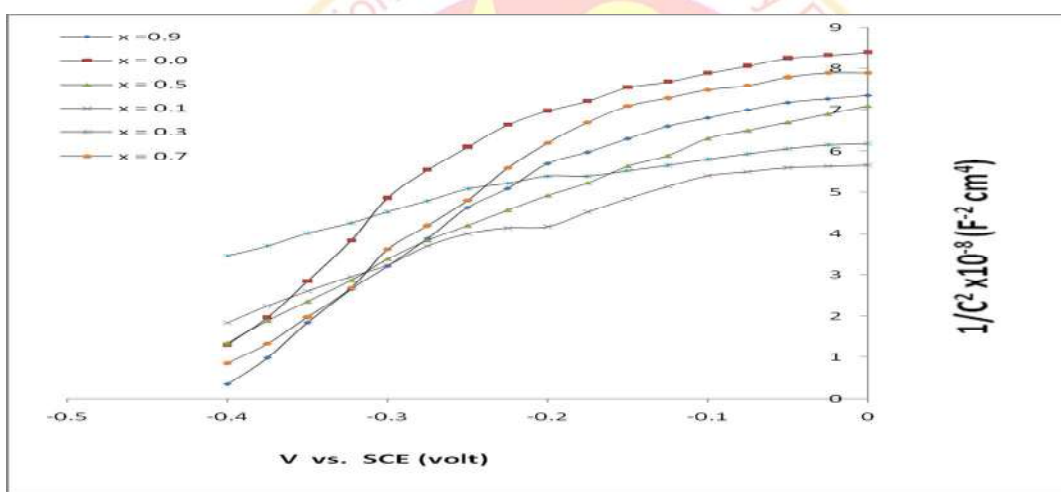

Figure 4. 1/C<sup>2</sup> versus d. c. bias voltage of Cd<sub>1-x</sub>Pb<sub>x</sub>Se

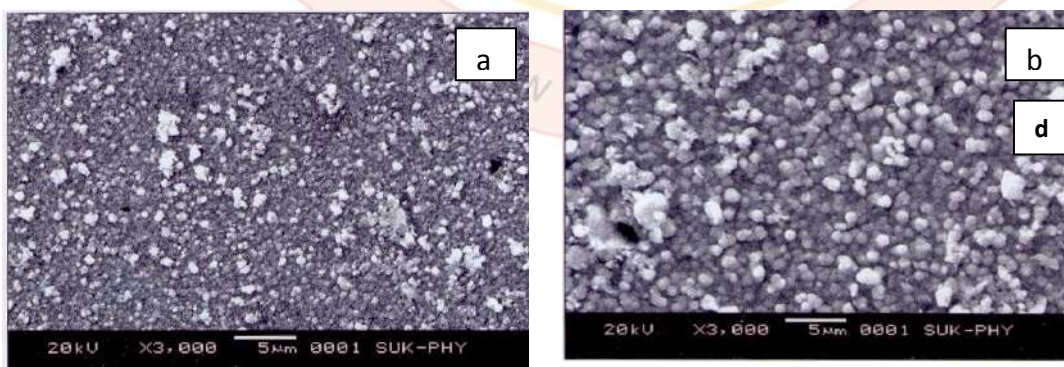
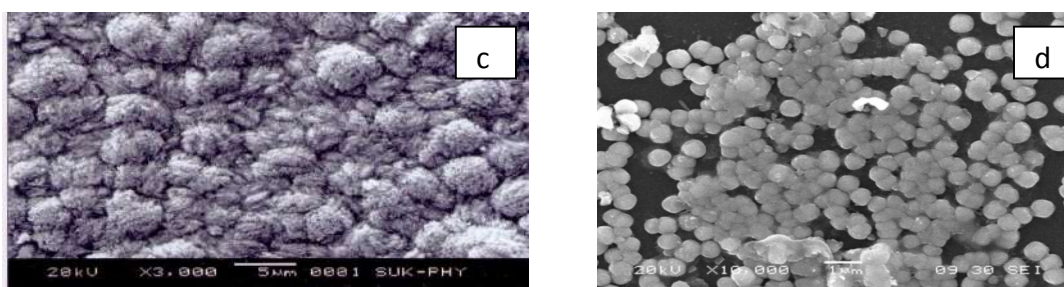

Figure 5. SEM Micrographs of Cd<sub>1-x</sub>Pb<sub>x</sub>Sethin films for four typical samples [ a) x=0.0 (CdSe), b) x=0.1, c) x=0.3, d) (PbSe)].





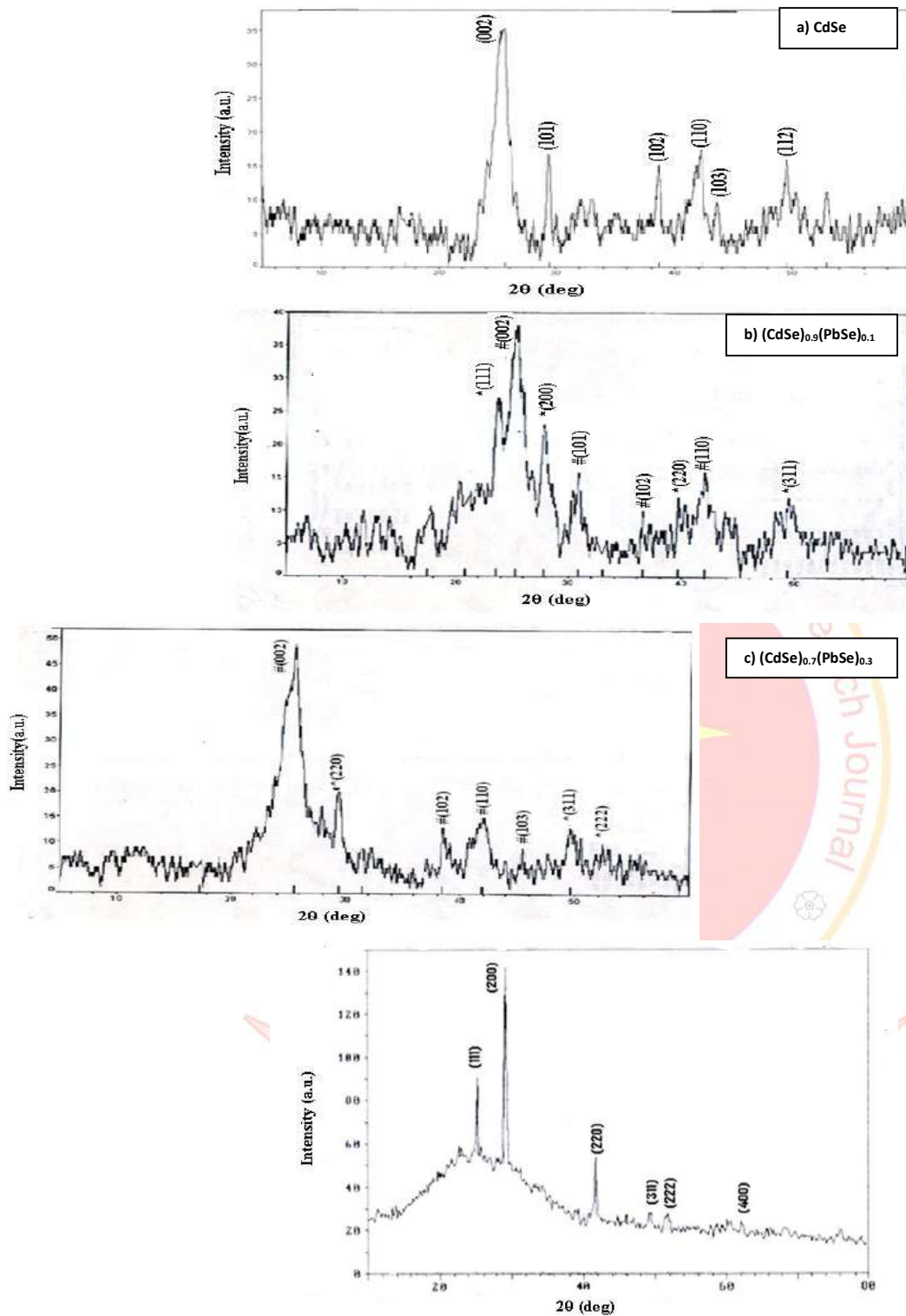

Fig.5.1. X-ray diffractograms of  $(\text{CdSe})_{1-x}(\text{PbSe})_x$  thin films for four typical samples [ a)  $x=0.0$  (CdSe), b)  $x=0.1$ , c)  $x=0.3$ , d)  $x=1.0$  (PbSe)]

## Eco-friendly protocol for Synthesis of bisindolylmethane

Rahul S. Patil

Dept of Chemistry

Yashwantrao Chavan College of Science, Karad.

**Abstract**

*Silica supported orthophosphoric acid has been utilized as an efficient catalytic system in the preparation of bisindolylmethane.*

Keywords :- Silica supported orthophosphoric acid, bisindolylmethane, plant material.

**Introduction**

Indole ring is a heterocyclic compound present in various plant material [1] its various derivatives shows pharmacological activities [2] such as effective in cancer cell activities [3]. bisindolylmethane shows important biological activity [4, 5]. So that numerous synthetic approaches were reported for the synthesis of bisindolylmethane by using  $\text{LiClO}_4$ , [6]  $\text{HCl}$ ,  $\text{H}_2\text{SO}_4$  [7]  $\text{AlCl}_3$ ,  $\text{BF}_3$  [8],  $\text{KHSO}_4$ -  $\text{SiO}_2$  [9],  $\text{NaHSO}_4$ -  $\text{SiO}_2$  [10], SAB-15/ $\text{SO}_3\text{H}$  [11],  $\text{H}_3\text{PW}_{12}\text{O}_{40}$  [12]  $\text{SiO}_2$ -TCCA [14], ionic liquids [15], trichloro-1,3,5-triazine [16], EP- PPA [17]. Such reported methods have limitations towards low yield, high reaction time decomposition of the catalyst tedious process of separation of the product. Therefore in connection with the development of new methodology use of silica supported orthophosphoric [13] is an important nature friendly protocol for the synthesis of bisindolylmethane.

**Result and discussion**

In continuation of our research in one pot multicomponent reaction we have developed eco friendly method of synthesis of bisindolylmethane. Completion of the reaction within short period of time and reusability was marked effective over the other catalyst.

In model reaction was carried out by different concentrations of catalyst but 30mg of the catalyst was very effective to carry out reaction between Anisaldehyde 2 mmol and indole 1 mmol the reaction mixture was stirred for about 40 min by using ethanol as a solvent at room temperature. Completion of the reaction was confirmed by TLC.

**General Procedure**

Chemical were purchased form Sigma Aldrich, Preparation of the catalyst was done by reported procedure [13].  $^1\text{H}$  NMR,  $^{13}\text{C}$  NMR spectra were recorded on 300MHz instrument by using  $\text{CDCl}_3$  as a solvent and TMS as a internal reference.

**Experimental procedure**

Mixture of aldehyde 2 mmol and indole 1 mmol silica supported orthophosphoric acid was added in catalytic amount (30mg) and stirred for about 40 to 60min by using ethanol as a solvent at room temperature completion of the reaction was monitored by TLC after completion of reaction separation of the catalyst is by simple filtration and purification of the product was done by column chromatography (Table 1 Entry 1-11). Catalyst wash with ethanol and water further it was dried prepared for further reactions. Reaction with various aldehydes were summarized in Table 1 (Entry 1-11).

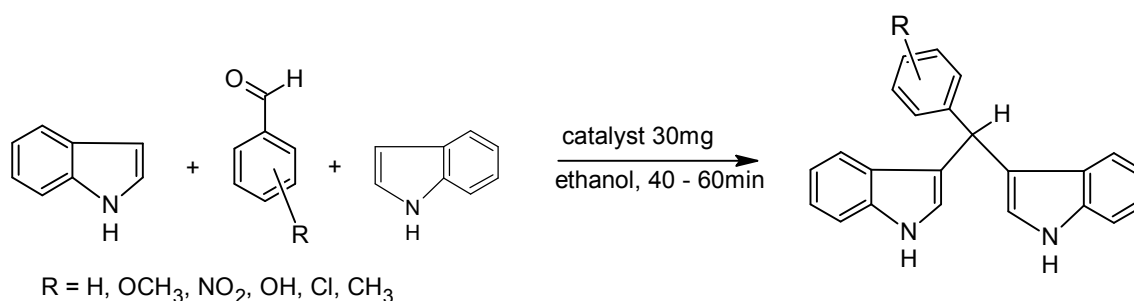
**Reaction**

Scheme 1

Synthesis of bisindolylmethane by reaction of indole and aldehydes

Table 1 . Synthesis of bisindolylmethane.

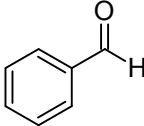
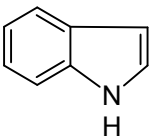
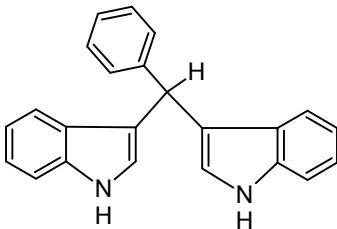
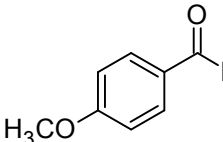
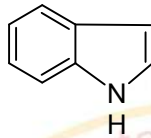
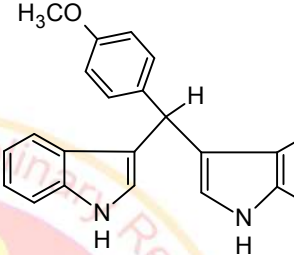
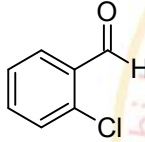
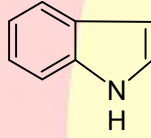
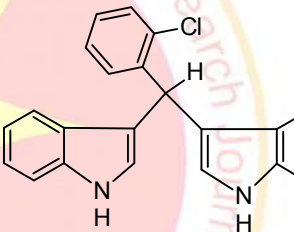
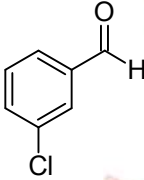
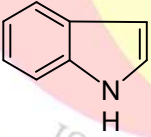
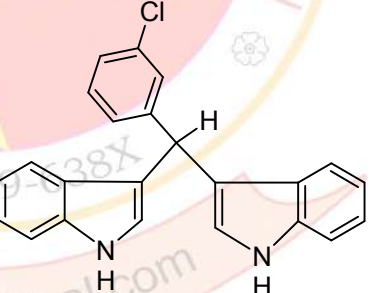
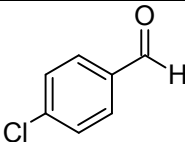
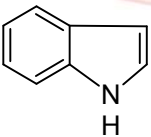
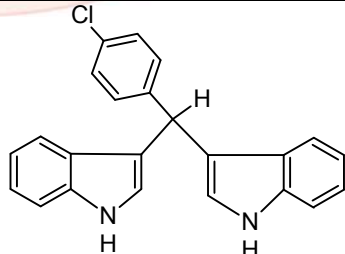
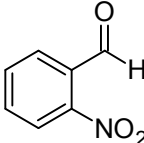
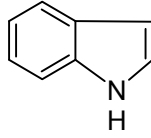
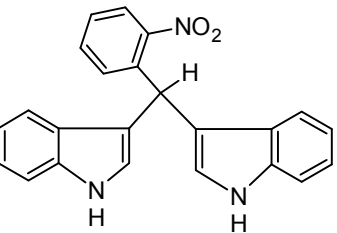
Entry	Aldehyde	Indole	Product	Time	Yield
1				45	90
2				40	91
3				45	89
4				42	90
5				47	88
6				42	89

			45	91
			43	90
			60	88
			47	87
			52	90

Table 2 Reusability of the catalyst

Run	1 <sup>st</sup>	2 <sup>nd</sup>	3 <sup>rd</sup>	4 <sup>th</sup>	5 <sup>th</sup>
Yield	90	90	88	87	80

**Reaction conditions:** Aromatic aldehyde (2 mmol), indole (1 mmol) H<sub>3</sub>PO<sub>4</sub>. SiO<sub>2</sub> (30 mg), ethanol (2mL), room temp : 40 min.

### Conclusion

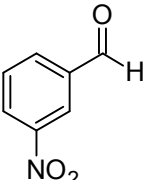
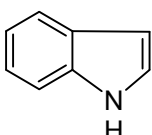
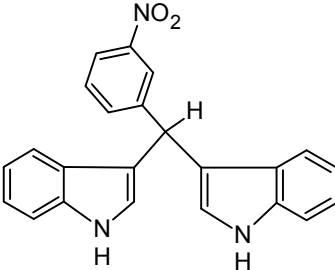
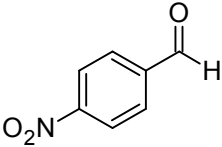
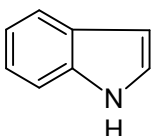
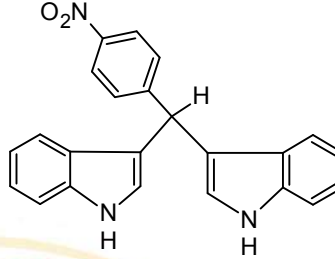
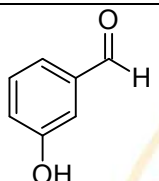
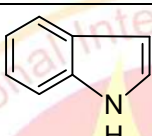
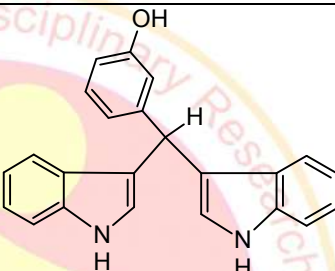
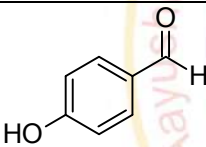
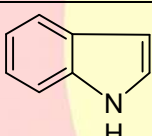
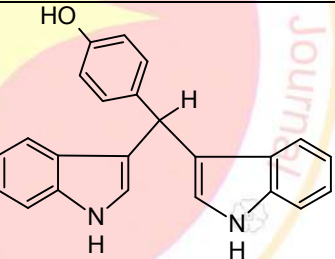
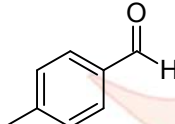
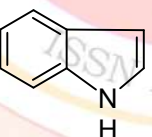
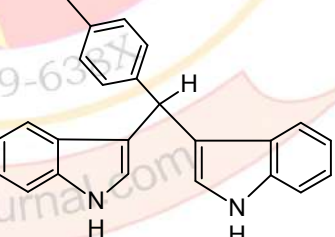
Process of formation of the product is very simple and environmental friendly approach. Recovery of the catalyst is very simple, yield of the product is very high, with in short period of the time, five times being effective reusability of the catalyst after that small change in the yield of the product observed (**Table-2**) due to leaching out of the catalyst these are the benefits of this reaction.

### Spectroscopic study

#### 3,3'-(phenylmethylene)bis(1H-indole)

$\delta = 7.92$  (3H, S),  $\delta = 7.40-7.32$  (m, 6H),  $\delta = 7.31-7.28$  (2H, m),  $\delta = 7.25-7.09$  (3H, m)

$7.02-6.98$  (2H, m),  $\delta = (2H, m)$ ,  $5.89$  (1H, s). C<sup>13</sup>NMR  $\delta = 145.00, 136.00, 130.8, 129.5, 129.00, 121.00, 125.40$

## References

1. Zeligs MA. Diet and estrogen status: The cruciferous connection. *J Med Food*. 1998;1(2):67-82.
2. Grubbs CJ, Steele VE, Casebolt T, et al. Chemoprevention of chemically-induced mammary carcinogenesis by indole-3-carbinol. *Anticancer Res*. 1995;15(3):709-16.
3. Benabadji SH, Wen R, Zheng JB, et al. Anticarcinogenic and antioxidant activity of diindolylmethane derivatives. *Acta Pharmacol Sin*. 2004;25(5):666-71.
4. Cragg, G. M., Grothaus, P. G. and Newman, D. "Impact of natural products on developing anti-cancer agents" *J. Chem. Rev.*, 109, pp.3012-3043 (2009), doi:10.1021/cr900019J.
5. Cordell, G. A. Introduction to alkaloids; A Biogenetic approach, Wiley, New York (1981)
6. Yadav JS, Reddy BV, Murthy CV, et al. Lithium perchlorate catalyzed reactions of indoles: An expeditious synthesis of bis (indolyl) methanes. *Synthesis*. 2001;2001(05):0783-7.
7. Gregorovich BV, Liang KS, Clugston DM, et al. Reductive C-alkylation. *Can J Chem*. 1968;46(21):3291-300.
8. Yadav JS, Reddy BV, Sunitha S. Efficient and eco-friendly process for the synthesis of bis (1H-indol-3-yl) methanes using ionic liquids. *Adv Synth Catal*. 2003;345(3):349-52.
9. Naidu KR, Khalivulla SI, Kumar PC, et al. KHSO<sub>4</sub>-SiO<sub>2</sub> catalyzed facile synthesis of bis (indolyl) methanes. *Org Comm*. 2012;5(3):150.
10. Naidu KR, Krishna BS, Anil Kumar M, et al. Design, synthesis and antiviral potential of 14-aryl/heteroaryl-14Hdibenzo[a,j] xanthenes using an efficient polymer-supported catalyst. *Molecules*. 2012;17:7543-55.
11. Naik MA, Sachdev D, Dubey A. Sulfonic acid functionalized mesoporous SBA-15 for one-pot synthesis of substituted aryl-14-H-dibenzo xanthenes and bis (indolyl) methanes. *Catal. Commun*. 2010;11(14):1148-53.
12. Azizi N, Torkian L, Saidi MR. Highly efficient synthesis of bis (indolyl) methanes in water. *Journal of Molecular Catalysis A: Chemical*. 2007;275(1):109-12.
13. A. D. Sawant, D. G. Raut, A. R. Deorukhkar, U. V. Desai, M. M. Salunkhe *Green Chemistry Letters and Reviews* 4 (2011) 235-240.
14. Vishvanath d. Patil\*, Prathamesh v. Gidh, Prasanna c. Patil, Nagesh Sutar and Ketan p. Patil *Int. J. Chem. Sci.*: 12(1), 2014, 248-252
15. G. Babu, N. Sridhar and T. P. Perumal, A Convenient Method of Synthesis of Bisindolyl-methane, Indium Trichloride Catalysed Reactions of Indole with Aldehydes and Schiff's Bases, *Synth. Commun.*, **30**, 1609 (2000).
16. H. Firouzabadi, N. Iranpoor and A. Ali Jafari, Preparation of Indolyl Methanes Catalyzed by Metal Hydrogen Sulfates, *J. Mol. Cat. A: Chem.*, 244, 168 (2006).
17. Marzieh Esmailpour, Batool Akhlaghinia and Roya Jahanshahi *J. Chem. Sci.* Vol. 129, No. 3, March 2017, pp. 313-328. *Indian Academy of Sciences*. DOI 10.1007/s12039-017-1246

## Impact Of Domestic Activities On Water Quality Parameters Of Kasari Freshwater Tank, Tal- Shahuwadi, Dist- Kolhapur (M.S.), India.

\*S.P.Patil, \*\*A.R.Dighe, \*\*\*H.K.Jadhav

\* Shri Jagdish Prasad Jhabarmal Tibrewala University,  
Dist. Jhunjhunu, Rajasthan.

\*\*Anandibai Raorane Arts, Commerce and Science college Vaibhavwadi,  
Dist. Sindhudurga.

\*\*\*Arts, Commerce and Science College , Naldurga,  
Dist. Osmanabad.

### Abstract:

*Kasari dam is mainly used for drinking, agricultural, domestic and industrial purpose. Human activity around the dam causes alteration in water quality parameters. The present study work is carried out to demonstrate effect of domestic activity on water quality of the dam. In this study work physico chemical parameters are analyzed monthly for the year 2018. In this investigation temperature, pH, turbidity, Total dissolved solids, conductivity and dissolved solids were analyzed. A considerable change in water quality parameters has been shown by this study work.*

**Key Words:** Domestic activities, Kasari dam, Physico chemical parameters.

### Introduction:

Aquatic ecosystem is very complex systems based on inter relationship between biotic and abiotic factors. Aquatic ecosystem is refuge for various plant and animal species also it is precious resources of fresh water. But it has been long used for domestic activities. The water reservoirs haven't capacity of self purification leading to destruction of this important ecosystem. Now day's large population influencing by these water resources. This ecology imbalance also effect ecological diversity of the dam. These are such many places influenced by domestic activities. Many workers denoted changing nature of water reservoirs such as Kumar (1985), Ruttner(1953) and Walia (1983). The present investigation shows the change in water quality of Kasari dam for year 2018.

### Study area:

The present research work has been carried in freshwater tank of Kasari Freshwater, Tal- Shahuwadi, Dist- Kolhapur (MS), India. Kasari Tank is medium Irrigation tank having the catchment area 32.28 sq.km. This dam is constructed in 2006. This dams water get benifited to 61 villafes from Panhala and Shahuwadi tahsil from Kolhapur district.

### Materials and methods:

For the investigation four different sampling stations were selected such as A,B,C and D for sampling . The samples were collected monthly throughout the year of 2018. The parameters liable to change with respect to place and time such as temperature and pH analyzed on the spot. The samples were collected in morning period. Samples were collected in 2 liter plastic can. The samples were brought to Laboratory and analyzed by using standard methods suggested by the Mohanta B.O. and Patra A.K. (2000), also APHA (1985). For turbidity method suggested by Sharma and Pandey (1998), Conductivity by Jaffer, Javed S.(1991), DO by Shivnikar et, al,(1999), temperature by Arvind et, al. were used.

### Result and discussion:

The collected samples were analyzed by using standard methods and the results were compared with each sampling stations and normal standard values. The results are shown below.

1. **Turbidity:** Turbidity value is slightly more at each sampling stations due to domestic activities and agricultural wastes.
2. **pH :** Alkaline pH was recorded at sampling station 'A'. It was highest due to effluents such as alkaline salts and decomposition of organic matter.
3. **Temperature:** Highest temperature recorded at sampling station 'A' due to degradation of organic matter and domestic waste at the sampling station.
4. **Conductivity:** Domestic activity adds various salts in the water which causes increase in conductivity value. Maximum conductivity recorded at sampling station 'A'.
5. **Dissolved oxygen:** Dissolved oxygen values are more due to domestic activities.
6. **Total Dissolved solids:** Total dissolved solids were more at sampling stations 'A' due to most domestic activity at this sampling station.

**Acknowledgement:**

The authors are thankful to the principal Dr.C.S. Kakade of Anandibai Raorane Arts, Commerce and Science College Vaibhavwadi for moral support and Laboratory facilities; also we are thankful to Principal Dr. M.G. Babare of ASC College, Naldurga for moral support and Laboratory facilities.

**References:**

1. APHA (1985): Standard method, for the examination of water XVII End.
2. Arvind, H.B. manjappa, S. and Pattaiah, B.T.( 1998): Correlation coefficient of some physic-chemical parameters of river Thounghhadra Karnataka poll Res 17 (4): 371-375.
3. Kumar, A (1985): Ecological studies of the Ulhas River. Ph.D thesis, university of Mumbai, India.
4. Mohanta, B.O. and Patra, A.K. (2000): Studies on the water quality index of river Sanmachhakandana at LeonzharGarh, Orissa, India. Poll.Res.19 (3): 375-355.
5. Ruttner, F (1953): Fundamental of luminology , university of torontoo press, 242.
6. Sharma, S.o. and Pande K.S. (1998): Pollution studies on Pangangariver at Moradabad. Physic-chemical characteristics and toxic metals, pollRes. 17(2): 201- 209
7. Shivshankar , S.V.Patil, a.M. Vaidya, D.F. and bandela N.N. (1999): Environmental temperature fluctuation determines oxygen level in Godavari River water, Poll Res. 18(4): 415-418.
8. Shukla S.C. Tripathi, B.O. rajanakinat, Deepkumari and pandey, V.S. (1989): Physico-chemical and biological Characteristic of river Ganga from Mirzapur to Balia Ind. T. Env. Hlth, Vol, 31(3): 218-227.
9. Walia, S.K. (1983): Hydrobiological investigation of river Tamil, Jammu, M.phil dissertation university of jammu.
10. Jaffer, Javed S. (1991): Comparative study of ecological pollution of reservoir and lakes in the vicinity of Ayrangabad and Godavari River at Paithan Maharashtra state, Ph.D. Thesis, Marathwada University, Aurangabad.

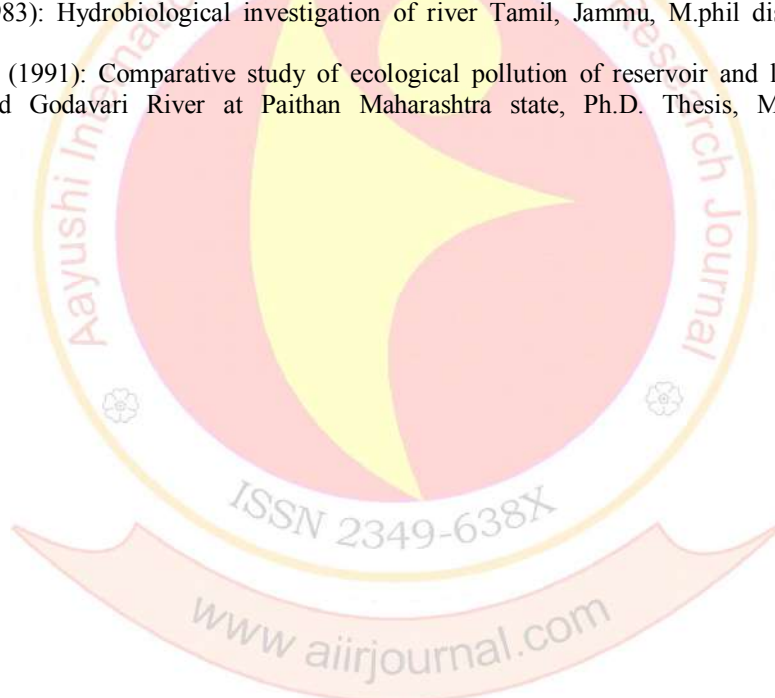

## Phyto-Chemical, Nutritional Screening & Antibacterial Activity Of Custard Apple (annona squamosa L.) Seeds extracts on e-coli !

Smita S. Giri<sup>a</sup>, Prabha R. Salokhe<sup>b</sup>

<sup>a</sup>Department of Chemistry; Gopal Krishna Gokhale Collge; Kolhapur

<sup>b</sup>Y. C. Warana Mahavidyalaya, Warananagar

### Abstract

Natural products derived from plants have proved that nature stands a golden mark to show the relationship between man and his environment. The research work was carried out to evaluate the Nutritional importance, antimicrobial activities of Seeds of Custard apple and their phytochemical screening. Four different solvent extracts of seed of Custard apple (*Annona squamosa* L.) were studied for its antibacterial activity. Agar diffusion method was selected to check antibacterial activity, whereas phytochemical analysis was done by TLC. Gram negative (*Escherichia coli*) bacteria & Yeast were selected for screening. The screening results showed that highest zone of inhibition was observed in methanol extract against *E. coli*. The present study demonstrates the presence of some phytochemicals (Proteins, carbohydrates, quinines, glycosides) in extracts which provide antibacterial activity. Custard Apple is used in Ice-cream and its very famous Ethanol and hot water were used to extract the active compounds from dry seeds of *Annona squamosa*. The phytochemical analysis of the extracts of the plant was also carried out to determine the active ingredients present in these extracts. The phytochemical analysis showed that the seed extracts contained alkaloids, saponin, tannin, terpenoid and flavonoids active ingredients in varying concentrations;

**Keywords:** Nutritional; Seeds Extracts of *Annona squamosa* Phytochemical Analysis , Antibacterial screening; TLC.

### I. Introduction:

There is an ever-growing need to develop more nutritionally-enhanced plants and plant products. The population of the earth is predicted to grow by more than two billion people by 2050. Nutritionally enhanced plants will play a central role in meeting the global demand for safe, healthy, and plentiful food. Sugar apple (*Annona squamosa* L.) was one of nutritious & mostly useable fruit in Kolhapur; Maharashtra; India. The pulp of ripe sugar apple can be processed into juice or other processed products. By products of sugar apple processing are seeds and peels still have many bioactive compounds [1]. The byproducts utilization are used to zero waste approaches that is environment friendly. Utilization of by products, study of oil seeds content from sugar apple fruits showed that it can produce biodiesel by transesterification method [2]. This fruit seeds has a few amino acids such as arginine, glutamine, serine, isoleucine, leucine, methionine, phenylalanine, tyrosine, and triptophan [3-4]. The previous study showed solvent for phenolic compounds extraction on pulp of sugar apple fruits from highest into the lowest were acetone, methanol, water, and ethanol, respectively [5]. This study purposed to know influences of the solvent, part of fruits seeds.

**II. Materials And Methods : Sample collection :** Fresh fruits of sugar apple (*Annona squamosa* L.) were collected from Panchgaon and Panhala, Kolhapur . Fresh fruits were separated seeds to be dried with tray dryer at temperature of 55°C constantly for 72 h. Seeds of fruits were used for proximate analysis. The seed were washed and air dried were ground into coarse powder and stored in air tight containers for further processing. Practicals were done in ISI Std; Nikhil Analytical Lab Sangli by their expertise.

**Preparation of extracts:** The extraction was carried out by Soxhlet extraction method. Extraction was done with maceration for 24 h at room temperature with various solvents. Comparison between the powder samples and extraction solvent was 10:100 (w/v). The solvent used was 80% methanol (v/v), 50% acetone (v/v), boiling water, and 50% ethanol (v/v). After maceration was done, filtrate was filtered and centrifuged at speeds of 3000 rpm for 15 mins. Supernatant was taken and residues was not used. Supernatant was used for chemical analyses.

**Proximate Analysis:** Proximate analysis was done by using method of AOAC, 2005.

**Phytochemical analysis Tests: Test for proteins:** Xanthoprotein test was done for proteins. Few drops of nitric acid added along the wall of test tube to the 1ml of extract. Formation of yellow color indicated the presence of proteins. [4]

**Test for carbohydrates:** About 1ml of Fehling A and Fehling B solution were added to the extract. This was heated for 30 min and observed for the formation of brick red color which confirmed the presence of carbohydrates.

**Test for resin:** About 5ml of distilled water was added to the extract and observed for the turbidity.

**Test for saponins :** About 0.1g of sample was mixed with 5ml of distilled water and allowed to boil. Then the mixture was filtered and 2 drops of olive oil was added in 1ml of filtrate. The mixture was shaken



and formation of emulsion and froth was observed. The 1ml filtrate was diluted by adding up to 4ml of distilled water. The mixture was shaken vigorously and observed for the stable froth.

**Test for flavonoids:** The filtrate was prepared by boiling the mixture of 0.5g of sample and 10ml of ethyl acetate for 1 min. Then the mixture was filtered and 4ml of filtrate was shaken with 1ml of 1% ammonium chloride solution. Formation of yellow color in the presence of ammonium solution indicates the presence of flavonoids.

**Test for phenols:** About 1ml of extract was mixed with 1ml of distilled water and warmed. To this 2ml of ferric chloride solution was added. Formation of green or blue color confirms the presence of phenols.

**Test for glycosides:** About 0.5ml of extract was taken in test tube and 1ml of glacial acetic acid was added to it containing traces of ferric chloride. To this solution 1ml of concentrated sulfuric acid was added. Formation of reddish brown color was observed in between the two layers. In the presence of glycosides upper layer turned bluish green.

**Thin layer chromatography :** TLC was performed on precoated silica gel TLC plates to identify the retention factor (Rf). TLC was used to separate the phytochemical components present in the extract. The ratio of solvents were used at following ratio methanol:chloroform (10:40), toluene: ethylacetate: acetic acid: formic acid (10:25:05:01), About 0.2 ml of aliquot was applied on TLC plates and immersed inside the solvent system. TLC plates were observed in ultraviolet chamber using 400nm long wavelength. The Rf values were calculated and based on the Rf values the components present in the extract were determined.

#### Nikhil Analytical Lab SANGLI [ ISI STANDARD] Reports ANALYSIS:

**Phytochemical analysis:** The different phytochemical tests revealed the presence of carbohydrates, flavonoids, glycosides and phenol in extract of *Annona squamosa* (Custard apple) seed. The phytochemical tests with the *Annona squamosa* (Custard apple) seed. SEED extract showed the presence of proteins, carbohydrates, Resins, flavonoids, Glycosides, phenols and saponins

**Phytochemicals Phytochemical profile : Emblica officinalis SEEDS :** 1] Proteins - +ve ; 2] Carbohydrates - +ve ; 3] Resins - +ve ; 4] Saponins - -ve ; 5] Flavonoids - -ve ; 6] Glycosides - +ve ; 7] Phenols - -ve ; 8] Quinones - +ve ; 9] Alkaloids - +ve ; 10] Tannins - -ve.

**Antimicrobial assay:** The methanol extracts of *E. officinalis* was analyzed for antimicrobial activity against the pathogens by agar-well diffusion inhibition test. Muller-Hinton agar plates were prepared and then the clinical pathogens were swabbed onto the plates. Four wells were aseptically punctured by using sterile borer and different concentrations (25 $\mu$ l, 50 $\mu$ l, 75 $\mu$ l and 100 $\mu$ l) of extracts were loaded into the wells. The plates were incubated at 37°C for 24h and the zone of inhibition was measured around the wells.

#### Antimicrobial activity of methanolic SEED extract from *Emblica officinalis*

S. No. Pathogen name Zone of inhibition (mm) value

- |    |                  |                                  |
|----|------------------|----------------------------------|
| 1] | Escherichia coli | -- cfu/g                         |
| 2] | Yeast & moulds   | 4 $\times$ 10 <sup>2</sup> cfu/g |

**Antimicrobial activity :** The results of the study showed that the SEED extracts of *Annona squamosa* (Custard apple) seed, indicates the presence of effective antimicrobial activity, which confirms its use against infection. The analysis of antimicrobial activity was based on measurement of inhibition zones formed around the wells. *Annona squamosa* (Custard apple) seed extract showed good inhibition effect against *Escherichia coli*. Yeast- 10 cfu/g. [5]

#### Proximate :

Proximate analysis indicates that sugar apple (*Annona squamosa* L.) fruit has high moistures, minerals, amino acids, and antioxidants. High moisture content of fruits cause possibility of microbial or fungal growth on fruit during storage. Ash content determines total mineral on fruits. Level of ripening of fruits affected production of secondary metabolites. Ripe sugar apple fruit have higher amino acids than unripe [Table 1]. The sugar apple fruits have various amino acids such as arginine, glutamine, serine, isoleucine, leucine, methionine, phenylalanine, tyrosine, and triptophan [5]. Leucine, valine, and phenylalanine are the amino acids that are the precursor of secondary metabolites such as flavonoid, alkaloid, etc. The concentration of vitamin C (ascorbic acid) showed its ability to scavenge reactive oxygen species and free radicals to prevent tissues damaged. This study showed that the highest concentration of vitamin C was at seeds of ripe sugar apple fruits [Table 1].

#### Conclusion:

The present study confirmed that the SEED extract of *Annona squamosa* (Custard apple) seed have great potential for antimicrobial activity against E-Coli. The phytochemical analysis revealed that the

SEED extract of *Annona squamosa* (Custard apple) seed proven to be more effective against antimicrobial activity. It doesn't have steroids, Alkaloids & phenols & rich in Protein, carbohydrates, saponins & Glycosides so it is used as very good nutritional and medicinal purpose.

#### Acknowledgement:

We are thankful to ISI STD NIKHIL ANALYTICAL LAB; SANGLI For providing us antimicrobial and phyto-chemical analysis.

**Table 1 Result of Proximate Analysis (Percentage± Standard deviation) - n=2**

Samples=	Ripe Seed
Moisture Content(%) =	6.82± 1.11
Ash Content(%) =	0.58± 0.36
Protein Content (%) =	6.85 ± 0.14
Vitamin-C Concentration (mg/100 g samples)	= 11.65 ± 0.09.

#### Reference:-

1. Shardul et al. 2013, Proximate analysis of peel and seed of *Annona squamosa* (Custard apple) fruit, Res J Chem Sci. 3(2), 92-94.
2. Kumar et al. 2010, Insecticidal activity of ethanolic extract of leaves of *Annona squamosa* L, J Chem Phar Res. 2(5), 177-180.
3. Srivastava et al. 2013, Assessment of phenol and flavonoid content in the plant materials, J New Bio Reports. 2(2), 163-166.
4. Shashikala et al. 2014, Studies on extraction of polyphenols from seeds of *Piper nigrum*, *Annona squamosa*, and *Malilcara zappota*, JEST-M. 3(2), 26-30.
5. Silva et al. 2014 Chemical composition and antioxidant activity of jatobá-do-cerrado (*Hymenaea stigonocarpa* Mart.) flour, Food Sci Tech Calminas. 34(3), , 597-603.

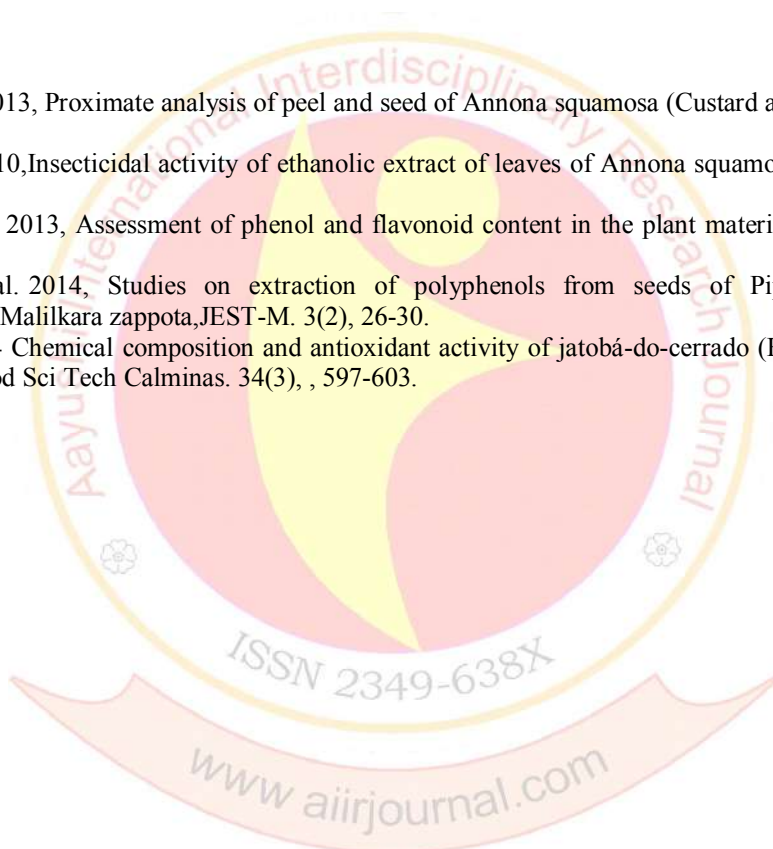

**Air Borne Deteriorating Fungi inside the Library at Koyana nagar ,M.S.****M.R.Shinde**

Balasaheb Desai College, Satara

*Airborne fungal agents cause a major loss to the library material in the form of foxing of paper, discoloring, and other type of damage. The present work was carried out in the library at Koyana nagar from June to May. Air monitoring was carried out by using Rotorod Air Sampler inside the college library, at Koyana nagar.*

*Out of 90 aerobiocomponents trapped, 85 were fungal spores out of which 8 types were responsible for destruction of paper. These 8 types with percentage contribution are Penicillium (11.9%), Cladosporium (5.02%), Aspergillus (3.61%), Alternaria (1.14%), Curvularia (0.41%), Rhizopus (0.04%), Cercospora (0.06%) and Chaetomium (0.1%) to the total air spora. All these fungal spores are the deteriorating agents' causes losses to monuments, paintings, and books (Tilak, 1975).*

**Key words-** Library, Book deterioration, air spora, Koyana nagar

**Introduction:**

Aerobiocomponents present in the indoor environment are responsible for respiratory disorders further airborne microbes are responsible for biodeterioration of storage materials, equipments, library materials and archives (Tilak, 1982). Biodeterioration is a biological process responsible for destruction of materials resulting in enormous economic loss all around the globe.

Fungi are main constituent of aerospora responsible for the major damages of cultural properties. Fungi are omnipresent and attack a different variety of substances such as textile, leather, paper, stone, wood, plastic, paintings etc. certain predominant fungi such as *Alternaria*, *Aspergillus*, *Cladosporium*, *Chaetomium*, *Curvularia*, *Helminthosporium*, *Penicillium*, *Paecilomyces*, *Torula*, *Trichoderma* etc are associated with biodeterioration of cultural property (Khandelwal, 2003)

The deterioration of library material caused by biological agents assumes serious contribution in many countries (Kowalik and Sadurska 1956, Kathapalia 1960, Tilak and Saibaba 1984, Vittal and Glory 1985, Mustafa 2013).

Wind current carries most of organisms responsible for damage. The main purpose of present investigation is to find out the cause and remedy of deterioration of books inside the library. Investigation by the air monitoring techniques was helpful in determining the number and percentage composition of various components of aerospora inside the library. Cellulase enzyme is responsible for breakdown of cellulose (Bose and Yadav, 1973).

The present paper deals with the study of biodeteriorating components in the Central library , Koyananagar

**Materials and Methods:**

The work was carried out by using Rotorod Air sampler. The Rotorod sampler was fully designed by Dr. W.A. Perkins in 1957 and modified by Dr. S.T. Tilak for trapping of air borne particles. The work has been carried out in Central library, Koyana nagar from 1<sup>th</sup> June 2015 to 25<sup>st</sup> May 2016 by keeping Rotorod air sampler operating for one hour early in the morning. The Rotorod Air sampler has been used for trapping wide variety of airborne particles. Smaller airborne particles are deposited on narrow cylinder oriented at right angle to high velocity of winds.

A small constant speed battery operated motor is used to whirl the aluminum rods about its axis at constant high speed. Collecting arms of the model are made up of 0.159 cm (1/16inch) square section aluminum rods slightly bend inward. The vertical arms are 6 cm long and 4cm from the axis. According to Gregory (1952) the width should give more than 60-70% efficiency of deposition for 20 $\mu$ m diameter spores at wind speeds about 4 m.p.h (2mm / Sec).The model employs D.C. control speed motor of the type used for the record players. The motor gives 2300 r.p.m.

The pieces of cello tape (transparent) 1.5cm length were stuck on each arms of aluminum rods of Rotorod air Sampler and smeared with Vaseline or petroleum jelly. After exposure of 60 minutes, tapes were removed, mounted on clean glass slide in glycerin jelly and covered with coverslip. Each and every time cello tape was changed.

**Scanning:-**

The total spore counts obtained on the known areas during morning were scanned under 10X 45X eye piece objective combination of the binocular research microscope regularly. The number of spores per unit volume of the air was computed with the help of conversion factor and trapping efficiency. Assuming the trapping efficiency to be 85% with the help of conversion factor, the number of spores counted on the tape of

known area was readily converted into an estimated number of spores per cubic meter of air. All timings are given in Indian standard Time (IST). The identification of spores was based on-

- 1) The microscopic characters
- 2) The comparison with parasitic and saprophytic fungal source material collected in and around the field and studied microscopically and comparing with the reference slides, (The live infected material collected from the surrounding areas and slides prepared by taking sections and scrapping).
- 3) The comparisons with cultural characters, in all possible cases specific and generic counts were made. The comparison is based on color, shape and other diagnostic characteristics of the spore. Identification was done by using standard literature and keys.

**Weather:-** During period of investigation daily record of temperature, rainfall and humidity were maintained. During this investigation period the minimum relative humidity was 37.96 % in May 2015, while maximum relative humidity was 93.25 % in July 2016.

### Result and Discussion:

Studies on composition of air spora indicate that there is correlation between meteorological parameters and percentage contribution of airspora, some spores may be transported through wind current or from outside sources. These spores encountered from air and also isolated from deteriorated parts of books. Tilak (1975) reported the presence of *Alternaria*, *Aspergillus*, *Rhizopus*, *Cladosporium* and *Curvularia* as common occurrence. Our findings correlate with this observation. Table No.1 showed observation of airspora and percentage contribution. The damage caused to the library material is in the form of foxing. The yellowing of paper is very common. *Penicillium*, *Aspergillus*, *Cladosporium* are found as major biodeteriorating fungal spores. Their percentage contribution is correlated with relative humidity and temperature. At moderate temperature and high relative humidity above 60%, all these spores showed higher percentage contribution. Fungal spores like *Alternaria*, *Aspergillus*, *Cladosporium*, and *Chaetomium* were dominant during wet period while their percentage contribution reduces dry period. Graph 1 showed the meteorological condition recorded during investigation period. The occurrence of binding threads (3.82%) in air is suggestive of deteriorated material of books inside the library hall.

In support of aerobiological studies petriplates with PDA were exposed after every fifteen days in triplicate inside library environment to study the effect of intramural environment on the growth of culturable fungi. Saprophytic fungi showed their presence on the expose petriplates. *Alternaria*, *Aspergillus*, *Cladosporium*, were found in all four months study. As these are most common saprophytic fungi, their count is highest in aeromycological study. Other fungi like *Rhizopus*, *Mucor*, and *Fusarium* showed their appearance in some petriplates. Our findings correlate with Al-Qurashi (2007).

**Table No1. Percentage contribution of the aerobiocomponents**

Sr.No	Genera of Fungi	Percentage contribution in total air-spora inside library
1	<i>Penicillium</i>	11.9%
2	<i>Cladosporium</i>	5.02%
3	<i>Aspergillus</i>	3.61%
4	<i>Alternaria</i>	1.14%
5	<i>Curvularia</i>	0.41%
6	<i>Rhizopus</i>	0.04%
7	<i>Cercospora</i>	0.06%
8	<i>Chaetomium</i>	0.1%
9	Other types	77.7%

**Graph1 .graph showing meteorological parameters**

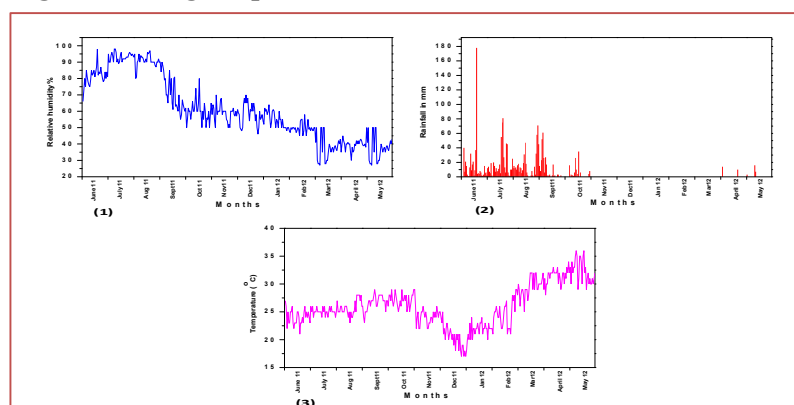

**Conclusion:**

High relative humidity is the major cause for the natural spread and presence of large number of spores and other aerobiocomponents. It is therefore important to have a continuous air monitoring so that effective control measures can be applied against airborne aerobiocomponents. Biodeterioration in the library material cannot be totally eradicated but to certain extent it can be reduced by using some precautionary measures

**Following suggestions are recommended based on the study:**

1. As the humidity plays the major role in biodeterioration, to reduce the humidity dehumidifiers and air conditioners may be used in the library.
2. Some fungicides have active role in controlling paper fungi, such type of fungicides may be used periodically.
3. Insecticides especially effective on mites may be frequently used so that there is less biodeterioration.
4. Proper maintenance of temperature is also used in avoiding biodeterioration.
5. Instead of wooden cabinets steel cabinets which are properly painted with antirust paints should be used in the library.
6. Regular monitoring of the aerobiocomponents is essential for the prevention of damage to the library material.

**References**

1. **Al-Qurashi, A.M. 2007.** Profiles of airborne fungi in schools of Saudi Arabia in relation to the allergy problems and respiratory diseases. *J. of food, Agriculture & environment.* 5(3&4):69-73.
2. **Greathouse, G.A. and C.J. Wessel, 1954.** Deterioration of materials, causes and preventive techniques. Reinhold Publ. Corp. New York.
3. **Kathapalia, Y.P. 1960.** Deterioration and conservation of paper I. Biological deterioration. *Indian pulp and paper.* 15: 117-125.
4. **Khandelwal, A. 2003.** Sampling and estimate of fungal biodeterioration of Lucknow, India. *AICCM BULLETIN* pp.76-81.
5. **Kowalik, R. and J. Sadurska, 1956.** Microorganisms destroying paper, leather and wax seals in the air of archives. *Acta micrologica Polonica .5:*227-284.
6. **M. Chadeganipour, 2013.** Bio-Deterioration of library materials: Study of fungi threatening printed materials of libraries in Isfahan University of medical sciences in 2011. *Undishapur Journal of microbiology.* 6 (2):127-131.
7. **Perkins, W.A.1957.** The Rotorod Sampler. 2<sup>nd</sup> semiannual report, Aerosol. Lab. Dept. Chemistry and Chem.Engng, Stanford Univ. CML.186:66.
8. **Tilak, S.T. and M. Saibaba, 1984.** Aerobiological approach to book deterioration in libraries. *J.Pl. Nature.* 1 (2): 1-10.
9. **Tilak, S.T., S. G. Pillai and M. Saibaba, 1981.** Components of air spora inside the library and its relevance to book deterioration *Proc. Nat. Conf. Env.Bio.* 173-177.
10. **Tilak, S.T.1982.** Aerobiology *Vaijayanti Prakashan. Aurangabad.*
11. **Vittal, B.P.R. and L.A. Glory, 1985.** Airborne fungus spores of a library of India. *Grana.* 24:129-133.

## Ethics in Research: An Introduction

**Dr. S.G. Jambhale**

Dept. Of Geography  
Y.C. Warana Mahavidyalaya,  
Warananagar

**Mr. V.G. Sawant**

**Dr. J. S. Jambhale- Patil**  
Junior College of Education Petala,  
Kolhapur

### What is Research?

Research is a process to discover new knowledge. It can be done with human beings, animals, plants, other organisms and inorganic matter. Research that involves human subject or participants raises unique and complex ethical, logical, social, legal and political issues. It is systematic investigation into and study at material and sources in order to establish facts and reach new conclusion. Also it is defined as a careful consideration of study regarding a particular concern or a problem using scientific methods.

According to American Sociologist, Earl Robert “Research is a systematic inquiry to describes, explain, predict and control the observed phenomenon”. It is careful study of a specific problem or concern using scientific methods, tools and instruments. It comprises creative and systematic works under taken to increase the stock of knowledge, including knowledge of humans, culture, society and use of this stock of knowledge to devise new application. Research has been defined as in a number of different ways and while there are similarities ways. There does not appear to be a single al encompassing definition that is embraced by all who engage in it.

According to Jhon W. Creswell, research is a process of steps used to collect and analyze information to increase our understanding of a topic or an issue.

### What is Ethics?

Ethics is a branch of philosophy that involves systematizing, defending and recommending concept of right and wrong conduct. Most people learn ethical norms at home, at school, in church or in other social settings. It seeks to resolve questions of human morality by defining concepts such as good and evil, right and wrong, virtue and vice, justice and crime. Ethics is two things. First, ethics refers to well founded standards or right and wrong that prescribe. What humans ought to do usually in terms of rights, obligations, and benefits to society, farness or specific virtue. Secondary, ethics refers to the study and development at one’s ethical standards.

### Ethics in Research:

We can use ethical concepts and principles to criticize, evaluate, propose or interpret laws. Ethics focus on the disciplines that stay standards of conduct, such as philosophy, theology, law, psychology or sociology. For instance, ethical standards govern conduct in medicine, law, engineering and business. Ethical norms also serve the aims or goals of research and apply to people who conduct scientific research or other scholarly or creative activities.

### Principle of ethics in Research :

1. **Honesty:** Honesty report data, results, methods and procedures and publication status. Do not fabricate, falsify or misrepresent data.
2. **Objectivity:** Strive to avoid bias in experimental design, data analysis, data interpretation , peer review, personal decisions, expert testimony and other aspects of research.
3. **Integrity:** Keep your promises and agreements act with sincerity. Strive for consistency of through and action.
4. **Carefulness:** Avoid careless errors and negligence. Carefully and critically examine your own work and the work of your peer’s. Keep good records of research activities.
5. **Openness:** Share data, results, ideas, tools, recourses. Be open to criticism and new idea.
6. **Respect for intellectual property:** Honor patents, copyrights and other forms of intellectual property. Do not use unpublished data, methods or results without permission.
7. **Confidentially:** Protect confidential communications, such as papers or grants submitted for publication, personnel records, trade or military secrets and patient’s records.
8. **Responsible Publication:** Publish in order to advance research and scholarship not a advance just your own career. Avoid wasteful and duplicative publication.
9. **Responsible Mentoring:** Help to educate mentor and advice students, promote their welfare and allow them to make their own decisions.
10. **Respect for Colleagues:** Respect your colleagues and treat them fairly.

11. **Social responsibility:** Strive to promote social good and prevent or mitigate social harms through research public and education.
12. **Non- discrimination:** Avoid discrimination against colleagues or students on the basis of sex, race and other factors that are not related to their scientific competence and integrity.
13. **Competence:** Maintain and improve your professional competence and expertise through life long education and learning, take steps to promote competence in science as a whole.
14. **Legality:** Know and obey relevant laws and institutional and governmental policies.
15. **Animal Care:** Show proper respect and care for animals when using them in research. Do not conduct unnecessary or poorly designed animal's experiments.
16. **Human Subjects protection:** When conducting research on human subjects, minimize harms and ricks and maximize benefits; respects dignity, privacy and autonomy.

**References:**

1. Gopal, M.A., An Introduction to Research Procedure in Social Science, Asia Publishing House.
2. John W. Creswell, Qualitative inquiry and Research Design: Choosing Among Five Approaches, 3<sup>rd</sup> Edition.
3. Kothari, C.R. , Research Methodology : Methods and techniques, Vishwa Prakashan , New Delhi, 1990.
4. Mertens, D.M. and Ginsberg, P.E. (Eds.)(2008) The Handbook of Social Research Ethics.
5. <https://libguides.library.city.edu.hk/researchmethods>



## Self-Cleaning Superhydrophobic Coating by ODS modified Silica Particles

Rajaram S. Sutar<sup>1</sup>, Vishnu S. Kodag<sup>1</sup>, Nikhil N. Pargaonkar<sup>1</sup>, Akshay R. Jundle<sup>1</sup>, Nilam B. Garge<sup>1</sup>, Shrutika S. Kshirsagar<sup>1</sup>, Narayan P. Kulkarni<sup>1</sup>, Susmita S. Kanchankoti<sup>1</sup>, Akshata S. Sawant<sup>1</sup>, Prashant S. Yadav<sup>1</sup>, Rutuja S. Gadade<sup>1</sup>, Monika M. Patil<sup>1</sup>, Varsha N. Patil<sup>1</sup>, S. R. Kulal<sup>2</sup>, A. K. Bhosale<sup>1\*</sup> and Sanjay S. Latthe<sup>1\*</sup>

<sup>1</sup> Self-cleaning Research Laboratory, Department of Physics, Raje Ramrao College, Jath - 416 404, Maharashtra, India.

<sup>2</sup> Department of Chemistry, Raje Ramrao College, Jath - 416 404, Maharashtra, India.

Corresponding author\*

### Abstract

Inspired from special wetting property of Lotus leaf, herein we prepared super water repellent coating on glass substrate by using a simple and dip coating technique. The superhydrophobic surfaces commonly shows water contact angle greater than  $150^\circ$  and tilting angle less than  $10^\circ$ . Here, we prepared silica particles by sol-gel process using tetraethylorthosilicate (TEOS) as a precursor. For hydrophobic modification, octadecyltrichlorosilane (ODS) was added in alcosol and further stirred for overnight. Thereafter, silica gel was dried at  $80^\circ\text{C}$  in oven for 5h. The prepared silica particles were dispersed in hexane. The pre-cleaned glass substrate was dipped and dried after multiple cycles. The water contact angle goes on increasing with increasing dipping cycle. For 25 dipping cycle, the superhydrophobic surface was attained with water contact angle  $\sim 157\pm 5^\circ$  and roll off quickly. The prepared superhydrophobic coating were characterized by water contact angle, sliding angle, adhesive tape test, water jet impact test and studied self-cleaning behavior.

**Keywords:** Silica particles, superhydrophobic, self-cleaning, lotus effect, wetting.

### Introduction

The highly water repellent and self-cleaning coating is an interesting topic in the coating field. A lotus leaf shows a unique wetting property in nature. The self-cleaning superhydrophobic property of lotus leaf has fascinated to researchers in the world. At first, Barthlott et al [1] have studied the surface microstructure of lotus leaf under high magnification scanning electron microscope. In scanning electron micrographs of lotus leaf surface, micro-nano sized dome-shaped or papillose epidermal cells covered with epicuticular wax were observed. This hierarchical micro-nanostructure supports extreme water repellency of the lotus leaf. The contaminating particles are picked up by water droplets and then removed with the droplets as they roll off the leaves. Cassie-Baxter [2] has considered that due to presence of air packets in micro- and nano-structured rough surface, contact between liquid and solid surface can be reduced which helps to strongly repel the water droplets and freely move anywhere on the surface.

In last two decades, many researchers successfully prepared the self-cleaning superhydrophobic surfaces by creating rough surface or depositing nanoparticle-polymer composite on flat surface. Rao et al [3] have prepared superhydrophobic silica films using sol-gel process by a simple dip coating technique. Latthe et al [4] have developed semi-transparent, durable and self-cleaning superhydrophobic coatings on glass using a silica-PMMA composite. Dhare et al [5] have prepared transparent water repellent silica coatings on glass substrates using iso-butyltrimethoxysilane (iso-BTMS) as a co-precursor via dip coating method. Ogihara et al [6] have sprayed the alcoholic suspension of hydrophobic  $\text{SiO}_2$  on paper and reported that roughness and superhydrophobicity depends on the aggregation states of nanoparticles, which depends on the type of alcohol used in the suspensions. Pawar et al [7] have prepared self-cleaning superhydrophobic silica coating by spin deposition technique from a mixture of hydrophobically modified silica particles and polystyrene. Recently, Latthe and research group applied hydrophobic silica nanoparticles on various industrial applicable surfaces including body of motorcycle, building walls, mini boat, solar cell panel, window glass, cotton shirt, fabric shoes, paper (currency notes), metal, wood, sponges, plastic and marble using simple dip and spray coating method [8].

In the present work, silica particles were prepared by sol-gel process using tetraethylorthosilicate (TEOS) as a precursor and surface modification of silica particles was carried out by adding octadecyl trichlorosilane (ODS) in alcosol. The silica particles are collected after drying the gel. The prepared hydrophobic silica particles are dispersed in hexane and deposited on glass slide by dipping and then dried at  $150^\circ\text{C}$  for 1hr. Deposited silica coating was characterized by measuring water contact angle, sliding angle, adhesive tape test, water jet impact test and self-cleaning behavior.

### Experimental

#### 1. Materials

Tetraethylorthosilicate (reagent grade, 98% Sigma Aldrich, USA), Octadecyltrichlorosilane ( $\geq 90\%$ , Sigma Aldrich, USA), Ammonium solution (25%, Molychem, India), Ethanol (99.9%, analytical reagent, India) and Hexane (Spectrochem, India).



## 2. Synthesis of hydrophobic silica particles

The silica sol was prepared by the following way, 5 ml  $\text{NH}_4\text{OH}$  was added in 50 ml ethanol and stirred for 15 min. and 5 ml TEOS was added under constant stirring to form silica sol. The whole sol was stirred for 1 h. For hydrophobic surface modification of silica particles, 0.3 ml ODS was added in silica sol and stirred for overnight. Silica particles are collected after drying silica gel at  $80^\circ\text{C}$  for 5h. The obtained powder was grinded well using mortar and pestle to achieve fine silica nanoparticles.

## 3. Preparation of Superhydrophobic coating

The 25 mg/ml of synthesized hydrophobic silica particles were dispersed in hexane. The cleaned glass slide was dip coated from the silica particle dispersion. The multiple layers of silica particles were applied on glass slide by dip coating. The coating applied on glass slide by dipping with speed 100 mm/s for 10 sec. dipping time in suspension and taken out with withdrawing speed 100 mm/s. The 5, 10, 15, 20 and 25 layers were deposited on glass slide. After every layer, the deposited slide was dried at room temperature and finally dried at  $150^\circ$  in oven for 2 h.

## 4. Characterizations

Deposited silica coatings were characterized by measuring water contact angle, sliding angle, adhesive tape test, water jet impact test and self-cleaning behavior. The static and dynamic water contact angles were analyzed by using Contact angle meter (HO-IAD-CAM-01, Holmarch Opto-Mechatronics Pvt. Ltd. India).

## Result and Discussion

### 1. Surface Wettability of prepared Superhydrophobic Coating

The deposition cycles were varied to confirm the increased surface roughness. With increasing deposition cycles from 5 to 25 cycles, the coating turns from transparent to semi-transparent in appearance which qualitatively confirms the increase in surface roughness. For lowest deposition cycles (5 deposition cycles), the water contact angle of  $78^\circ$  was attained and for further 10, 15 and 20 deposition cycles, the water contact angle gradually increases to  $115$ ,  $129$  and  $145^\circ$ , respectively. The water contact angle of  $157 \pm 5^\circ$  (Fig.1 b) was attained for the 25 deposition cycles. The Fig.1a depicts the superhydrophobic glass plate and spherical colored water drops placed on it. The air pockets trapped in rough interstices of the superhydrophobic coating minimizes the water – solid contact area and water drops sits on composite air-solid interface.

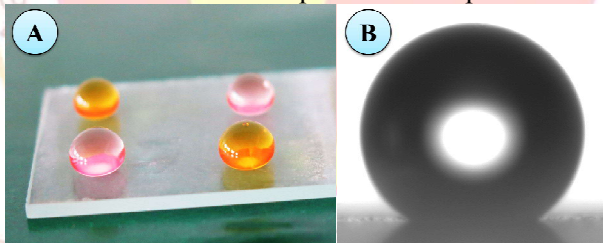

Fig.1: a) The optical image of colored water drops on superhydrophobic coating, b) Image of water droplet on superhydrophobic coating.

### 2. Water Jet Impact Test and Adhesive Tape Test

The mechanical stability and durability was studied by impacting water jet on superhydrophobic coating and performing adhesive tape test on superhydrophobic coating. The prepared superhydrophobic coating was stable against water jet impact. Fig. 2 depicts the optical image of water jet impacting on the superhydrophobic coating. Even after water jet impact for continuous 10 min, the surface showed unchanged wettability. The adhesive tape was applied on prepared superhydrophobic coating and smoothly pressed by finger to ensure good contact between tape and coating. The tape was peeled off smoothly; this process was repeated 15 times. After adhesive tape test the negligible change in the static water contact angle reveals that the prepared superhydrophobic coating was mechanically stable.

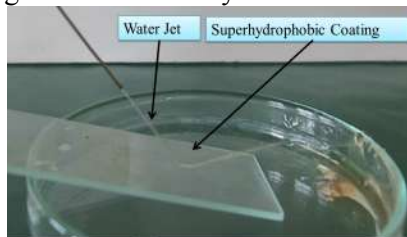

Fig. 2: Optical image of water jet impact test on superhydrophobic coating

### 3. Self-Cleaning Behavior of Superhydrophobic Coating

The candle soot dust was spread on superhydrophobic coating randomly. The water droplets were sprinkled on dusted superhydrophobic surface. From this experiment it is clearly revealed that the sprinkled water droplets picked up the candle soot particles and roll away quickly and completely cleaned the

superhydrophobic surface. **Fig. 3** clearly shows the optical image of the self-cleaning ability of the superhydrophobic coating.



**Fig. 3:** Self-Cleaning property of superhydrophobic coating.

### Conclusion

The hydrophobic silica particles were prepared by modification of hydrophilic silica particles by ODS. The self-cleaning superhydrophobic coating was successfully applied on glass substrate. In this work prepared superhydrophobic surface exhibited water contact angle  $157^\circ$  and roll off at angle less than  $10^\circ$ . The superhydrophobicity depends on the number of layers of silica particles applied on glass substrate. The water jet impact test and adhesive tape test reveals prepared superhydrophobic coating is mechanically stable. The highly water repellent and adherent coating can be applicable on paper, cotton, fabric, sport materials, metal, marbles, vehicle glass, windows glass and many.

### Acknowledgments

This work is financially supported by DST – INSPIRE Faculty Scheme, Department of Science and Technology (DST), Govt. of India. [DST/INSPIRE/04/2015/000281].

### References

1. Barthlott, Wilhelm, and Christoph Neinhuis. "Purity of the sacred lotus, or escape from contamination in biological surfaces." *Planta* 202.1 (1997): 1-8.
2. Cassie, A. B. D., and S. Baxter. "Wettability of porous surfaces." *Transactions of the Faraday society* 40 (1944): 546-551.
3. Rao, A. Venkateswara, et al. "Preparation of MTMS based transparent superhydrophobic silica films by sol-gel method." *Journal of colloid and interface science* 332.2 (2009): 484-490.
4. Latthe, Sanjay S., et al. "Development of sol-gel processed semi-transparent and self-cleaning superhydrophobic coatings." *Journal of Materials Chemistry A* 2.15 (2014): 5548-5553.
5. Dhere, Sunetra L., et al. "Transparent water repellent silica films by sol-gel process." *Applied Surface Science* 256.11 (2010): 3624-3629.
6. Ogihara, H., et al., Simple method for preparing superhydrophobic paper: spray-deposited hydrophobic silica nanoparticle coatings exhibit high water-repellency and transparency. *Langmuir*, 2012. 28(10): p. 4605-4608
7. Pawar, Popat G., et al. "Polystyrene assisted superhydrophobic silica coatings with surface protection and self-cleaning approach." *Progress in Organic Coatings* 105 (2017): 235-244.
8. Latthe, Sanjay S., et al. "Self-cleaning superhydrophobic coatings: Potential industrial applications." *Progress in Organic Coatings* 128 (2019): 52-58.

## Women Empowerment By Self Help Groups (Shgs): A Case Study Of South West Villages Of Walwa Tehasil , Sangli District (Maharashtra)

**Dr. Mrs. Snehal Makarand Rajhans**

Krishna Mahavidhyalaya Rethare Bk.

### Abstract

*In Maharashtra there are many grate personalities inspiring to people. Some freedom fighter and social worker are spent their life for the development of weaker people. Mahatma Fule and Savitribai Fule are work for the women's education and their development. After independence there are introduced some programme and policies for women empowerment.*

**Key Words** SGSY, SHGs

### Introduction -

In Maharashtra there are many grate personalities inspiring to people. Some freedom fighter and social worker are spent their life for the development of weaker people like Chatrapati Shivaji Maharaj, Rajmata Jijabai, Mahatma Fule, Rajashree Shahu Maharaj, Maharshi Karve, Karmaveer Bhaurao Patil, Vitthal Ramaji Shinde. Mahatma Fule and Savitribai Fule are work for the women's education and their development. After independence there are introduced some programme and policies for women empowerment. Mahatma Gandhi, Pandit Jawaharlal Neharu and Indira Gandhi are introduced the new programme for women empowerment. There are no freedom for women and weaker section in India. The women empowerment policies are started after independence because of the contributinal work of these grate personalities.

Government lunched various programme for women's development. The Swarnajayanti Gram Swarojgar Yojana (SGSY) a new and holistic self-employment programme for the rural poor was launched on 1<sup>st</sup> April 1999. The SGSY is a definite objective of improving the family incomes of the rural poor and at the same time, providing for a flexibility of design at the grassroots level to suit the local needs and resources. The objective of SGSY is to bring the assisted poor families (swarojgaris) above the poverty line in three years, by providing them income-generating assets through a mix of bank credit and government subsidy. It would mean ensuring that the family a monthly net income of at list Rs. 2000. Subject to availability of funds, the effort is to cover 30% of the poor families in each block during the next five years. Quality is the hallmark of SGSY, which is to be imaginatively used to bring people above the poverty line and as well as women empowerment.

After independence Government is also focus on women development but today the women's problem are incised. The condition of women's undevelopment need to be changed for availing the existing opportunities. Self Help Groups are play an important role in socially, economically and politically development of women. That's why there is a need to study the implementation and impact of Self Help Groups and the role of SHGs in women empowerment all over India. So it is the need of such type of research.

Government of India established a scheme for rural women for their upliftment. In 1999 Government of India launched Swarnjayanti Gram Swarojgar Yojana (SGSY). In Sangli district also implement this scheme in large scale. Rural women participate in this scheme and solved their daily needs. In this paper we studied the impact of this scheme in rural area. Therefore we selected four village and analysis the scheme which benefited for women. Self Help Groups (SHGs) are one of the ways to developed women's life

### Objectives -

The main objective of the present paper is to study the role of Self Help Groups in women empowerment and to study the socio- economic profile of the beneficiaries of Self Help Groups.

### Methodology And Database

The present study is carried out with primary data which compiled by the researcher and secondary sources of data, like books, journals, magazine, internet etc. and analysis this data by various tools and techniques.

### Study Area

Sangli district is divided in to 10 tehasil. Walwa tehasil is a most important tehasil of sangli district. So we selected the four villages of walwa tehasil for case study. At the foot of the hill, the plateau area, the national highway, the industrial area and the bank of the river these physical and social factors are considered

in the selection of the villages. In these villages collect the primary data with the help of Interview, Questionnaire and Schedules

### Socio-Economic Profile Of The Beneficiaries Of Self Help Groups

In this paper the information was collected from 4437 beneficiaries who had received benefits under Self Help Groups and an attempt has been done to analyze the general particular and present socio- economic profile of the beneficiaries selected for the study.

#### 1. Chikurde

Village Chikurde is situated in Walwa tahsil at the bank of river warana, some 25 km. south west of Islampur town. The Village Panchayat was established on 1962. The population of this village is 8267 (2011 census); this includes 4273 males and 3994 females. SC population is 861 including 428 males and 433 females; ST population is 15, which include 8 males and 7 females. The average sex ratio of this village is 935 and the literacy rate is 80.22 %. In Chikurde Male literacy is 88.90% while female literacy rate is 71.17%.

Total number of families in the village is 1794. Out of which 274 families are Below Poverty Line. These BPL families include 175 from BC and 99 from open categories. The village Chikurde has one primary schools and one secondary school, in addition to this there are six nursery schools, one higher secondary school. The village has one health center run by Zilla Parishad.

The village has well organized drinking water supply scheme from a village well. There are many facilities like irrigation, co-operative primary milk societies and co-operative credit society. There is a branch of Sangli District Central Co-operative Bank , Bank of India and Warana Bank. In this village there is one lady selected for last five year as a Zilla Parishad member, one is selected in Panchayat Samitee member, and 17 women members in Grampanchayat body..

Total area of this village is 1229 hectares. Out of which 935 hectares area is irrigated and 95.33 hectors unirrigated area. Irrigation is through mainly private wells and through warana Irrigation Scheme, which lift water from river warana. The major crops are jawar, groundnut, rice and sugar cane.

#### Total no of Self Help Groups and Beneficiaries in Chikurde

Sr. No.	Years	Self-Help Groups		Total No of Beneficiaries
		BPL	APL	
1	2010-2011	3	57	771
2	2011-2012	1	22	296
3	2012-2013	1	16	218
4	2013-2014	0	2	26
5	2014-2015	2	5	85
6	<b>Total</b>	<b>07</b>	<b>102</b>	<b>1396</b>

**Source:** Compiled by the researcher from the record of grampanchayat office Chikurde

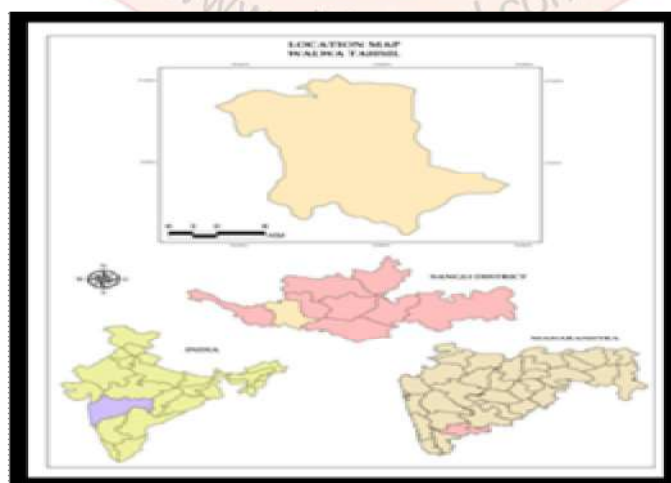

One hundred nine Self Help Groups have been established in the village Chikurde under Swarn-Jayanti Gram Swarojagar Yojana. Out of which 07 Self Help Groups are of the women Below Poverty Line, and 102 are of the women Above Poverty Line Self Help Groups. Women from these Gats have become economically strong. Women from two BPL SHGs taken 2 lakh lone from DCC bank . They have deposited Rs. 1.81 lakh as

savings in bank and put out the loan of Rs. 2 lakh. This has checked the private money lending in the village Women from APL Self Help Groups are saving Rs.23.9 lakh, and are disbursed with Rs. 19.25 lakh for their day-to-day needs.

## 2. Vashi

Village Vashi is situated in Walwa tahsil at the bank of river warana, some 14 km. south of Islampur town. The Village Panchayat was established on 16-05-1955. The population of this village is 3538 (2011 census); this includes 1836 males and 1702 females. SC population is 451 including 222 males and 229 females; ST population is not in this village. The average sex ratio of this village is 944 and the literacy rate is 81.53 %. In K.M.Gad Male literacy is 88.43% while female literacy rate is 74.29%.

Total number of families in the village is 649 Out of which 97 families are Below Poverty Line. These BPL families include 14 from BC and 83 from open categories. The village Vashi has two primary schools and one secondary school, The village has no health center run by Government, but there are five private dispensaries.

The village has well organized drinking water supply scheme. There are many facilities like irrigation, co-operative primary milk societies and co-operative credit society. There are no bank facilities in village. In this village there is one lady selected as lady Sarpanch and six women members in Grampanchayat body.

Total area of this village is 547 hectares. Out of which 468 hectares area is irrigated, 58 hectares unirrigated area and 79 hectares area in forest. Irrigation is through mainly private wells and through Rajarambapu Irrigation Scheme, which lift water from river Warana. The major crops are jawar, soysbeen, groundnut, wheat, rice and sugar cane.

### Total no of Self Help Groups and Beneficiaries in Vashi

Sr. No.	Years	Self-Help Groups		Total No of Beneficiaries
		BPL	APL	
1	2010-2011	03	21	303
2	2011-2012	01	07	101
3	2012-2013	01	06	88
4	2013-2014	00	01	13
5	2014-2015	01	04	62
6	<b>Total</b>	<b>06</b>	<b>39</b>	<b>567</b>

**Source:** Compiled by the researcher from the record of Grampanchayat office Vashi

Fourty five Self Help Groups have been established in the village Yedenipani under Swarn-Jayanti Gram Swarojagar Yojana. Out of which 06 Self Help Groups are of the women Below Poverty Line and 39 are of the women Above Poverty Line Self Help Groups. Women from BPL SHGs have improved their traditional occupations like animal husbandary, broom making, rope making etc. They have deposited their savings in bank and put out the loan. This has checked the private money lending in the village Women from Self Help Groups are getting money for their day-to-day needs.

## 3. Kameri

Village Kameri is situated in Walwa tahsil on the National Highway-4, some 06 km. south of Islampur town. The Village Panchayat was established on 01-11-1940. The population of this village is 10477 (2011 census); this includes 5399 males and 5078 females. SC population is 1216 including 596 males and 620 females; ST population is 11, which include 06 males and 05 females. The average sex ratio of this village is 941 and the literacy rate is 90.59 %. In Kameri Male literacy is 95.40% while female literacy rate is 85.56 %.

Total number of families in the village is 2158. Out of which 321 families are Below Poverty Line. These BPL families include 102 from BC and 219 from open categories. The village Kameri has three primary schools and four secondary school, in addition to this there are six nursery schools, one Asharam School. The secondary school is only for girls. The village has one health center run by Zilla Parishad.

The village has well organized drinking water supply scheme from a village well. There are many facilities like irrigation, co-operative primary milk societies and co-operative credit society. There are two important primary milk co-operative societies. There is a branch of Sangli District Central Co-operative Bank. In this village there is one lady selected in Panchayat Samitee member, a lady Sarpanch and seven women members in Grampanchayat body.

Total area of this village is 2284 hectares. Out of which 1129 hectares area is irrigated and 231.33 hectares unirrigated area. Irrigation is through mainly private wells and through Rajarambapu Irrigation Scheme, which lift water from river Krishna. The major crops are jawar, groundnut, rice and sugar cane.

**Total no of Self Help Groups and Beneficiaries in Kameri**

Sr. No.	Years	Self-Help Groups		Total No of Beneficiaries
		BPL	APL	
1	2010-2011	13	67	1081
2	2011-2012	07	22	385
3	2012-2013	02	13	204
4	2013-2014	01	05	81
5	2014-2015	02	06	106
6	<b>Total</b>	<b>25</b>	<b>113</b>	<b>1857</b>

**Source:** Compiled by the researcher from the record of Grampanchayat office Kameri

One hundred thirty eight Self Help Groups have been established in the village Kameri under Swarn-Jayanti Gram Swarojagar Yojana. Out of which 25 Self Help Groups are of the women Below Poverty Line and 113 are of the women Above Poverty Line Self Help Groups. Panchayat Samitee has given training to the Self Help Groups, like making Purses, washing powder, incense-sticks, indigo and phenel. Women from these Gats have become economically strong. Women from BPL SHGs have improved their traditional occupations. They have deposited their monthly savings in bank and put out the loan for purchasing the animal. Women from APL Self Help Groups are getting lone for their small business and their day-to-day needs.

**4. Dhagewadi**

Village Dhagewadi is situated in Walwa tahsil at the foothill of Dhagewadi hill, some 19 km. south west of Islampur town. The Village Panchayat was established on 24-11-1966. The population of this village is 9144 (2011 census); this includes 4809 males and 4335 females. SC population is 1431 including 748 males and 683 females; ST population is 47, which include 24 males and 23 females.. The average sex ratio of this village is 901 and the literacy rate is 81.33 %. In Sakharale Male literacy is 87.94% while female literacy rate is 74.13%.

Total number of families in the village is 152. Out of which 28 families are Below Poverty Line. These BPL families include 07 from BC and 21 from open categories. The village Dhagewadi has one primary school. In the village there has no health facility.

The village has well organized drinking water supply scheme. There are no irrigation facilities. There are two milk societies. There are no banking facilities. In this village there is one lady selected as lady deputy Sarpanch and four women members in Grampanchayat body..

Total area of this village is 353 hectares. Out of this most of the area is unirrigated area. There is 250 hectares forest area. The major crops are jawar, groundnut and soyabeen.

**Total no of Self Help Groups and Beneficiaries in Dhagewadi**

Sr. No.	Years	Self-Help Groups		Total No of Beneficiaries
		BPL	APL	
1	2010-2011	01	02	40
2	2011-2012	01	01	25
3	2012-2013	00	01	15
4	2013-2014	00	00	00
5	2014-2015	00	01	15
6	<b>Total</b>	<b>02</b>	<b>05</b>	<b>95</b>

**Source:** Compiled by the researcher from the record of Grampanchayat office Dhagewadi.

Seven Self Help Groups have been established in the village Yedenipani under Swarn-Jayanti Gram Swarojagar Yojana. Out of which 2 Self Help Groups are of the women Below Poverty Line and 05 are of the women Above Poverty Line Self Help Groups. Women from these Gats have become economically strong. There are no banking facilities in the village, so the womens of this village are not interested in this SHG's. Women from BPL SHGs have improved their traditional occupations like broom making, rope making etc. Women from two BPL SHGs taken 2.50 lakh lone from DCC bank . They have deposited Rs. 1.00 lakh as savings in bank and put out the loan of Rs. 2.50 lakh for purchasing buffalo. This has checked the private money lending in the village.

**Total no of Beneficiaries in selected villages (2010 to 2015 )**

Sr. No	Years	Sample villages of Walwa Tahsil				Total
		Chikurde	Vashi	Kameri	Dhagewadi	
1	2010-2011	771	303	1081	40	2195
2	2011-2012	296	101	385	25	807
3	2012-2013	218	88	204	15	525
4	2013-2014	26	13	81	00	120

5	2014-2015	85	62	106	15	268
6	<b>Total</b>	<b>1396</b>	<b>567</b>	<b>1857</b>	<b>95</b>	<b>3915</b>

**Source:** Compiled by the researcher from the record of Grampanchayat office

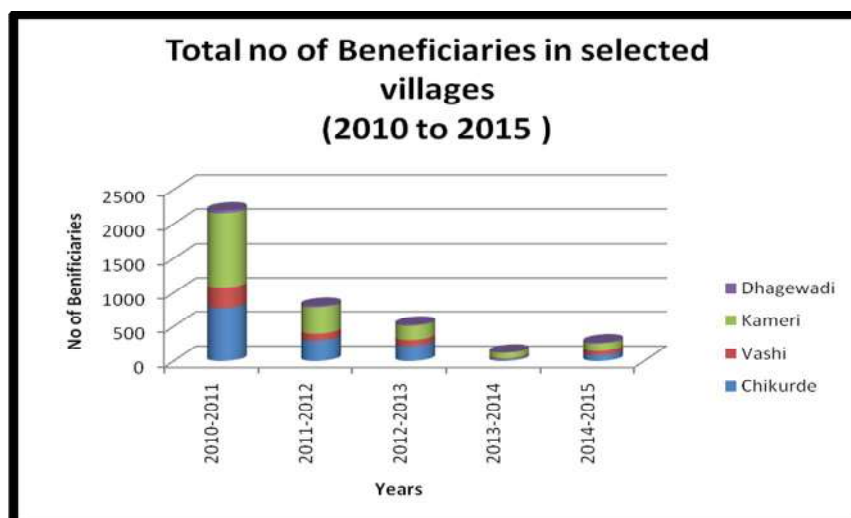

**Source:** Compiled by the researcher from the record of Grampanchayat office

### Findings and Suggetions

On the basis of field survey and observations an insight is obtained in the implementation of the Swarnajayanti Gram Swarojgar Yojana (SGSY). The major findings and suggestions of the present study are listed below

- 1) Study of the sample villages in the taluka reveals that the women in the selected villages have participated to a greater extent in the Swarnajayanti Gram Swarojgar Yojana (SGSY), sponsored by the State and the central Government.
- 2) In the 4 selected villages there are total 3915 beneficiaries who are benefited from the Swarnajayanti Gram Swarojgar Yojana (SGSY).
- 3) It was found from the case study, majority that is 100 percent of beneficiaries who participated in these schemes were females.
- 4) In the selected villages 299 Self Help Groups were established in under Swarnajayanti Gram Swarojgar Yojana and some 3915 beneficiaries involved in it.
- 5) In the selected village the participation of women in SHGs are very less at the foot of the hill village Dhagewadi. The plateau area in village Vashi the participation of women in SHGs are moderate . The bank of the river and the industrial area are very developed in participation of women in SGSY like the village Kameri and Chikurde.
- 6) The important problem found in all the selected villages is of identification of BPL families. Therefore, it is suggested that fool proof procedure of identifying BPL families should be adopted so that the benefits of the programme should go to the real poor and deserving families.
- 7) In hilly region due to ignorance and illiteracy of beneficiaries the poor people were unaware of Self Help Groups. It is essential that rural people must be made aware of the schemes which aims at women empowerment..
- 8) The BPL beneficiaries are unable to repay the loan amount so the SHGs are closed. The banks have not taken the SHGs in gradation because of this the beneficiaries do not get the loan amount and subsidy. Therefore, it is suggested that the BDO and Bank Officers should give the detail information about the scheme to illiterate women. So they should keep the record of the SHGs up-to-date.
- 9) The amount of the loan disbursed is not sufficient to carry on the business activities profitably. Generally the additional income instead of saving and reinvesting is used for domestic needs and they have no money left for repayment of the loans.
- 10) In the selected villages Dhagewadi are located in the hilly area. There are no transport and communication facilities from the villages to the tehsil Head Quarter Islampur. To overcome this problem it is suggested that the BDOs should visit the hilly area at regular intervals. They should also provide advisory facilities about the RDPs to the needy families. This step can save time and money of the families especially in villages in hilly region.
- 11) It is clear from the sample studies that in hilly as well as remote areas the participation of women in Swarnajayanti Gram Swarojgar Yojana (SGSY) is not satisfactory. Without womens participation the success can not be achieved Therefore it is suggested that the Government Organizations and Non

Government Organizations so also the Voluntary Organizations should take up programmes to increase the participation of the women in the Swarnajayanti Gram Swarojgar Yojana (SGSY).

- 12) Under Swarnajayanti Gram Swarojgar Yojana (SGSY) schemes government gives funds and subsidy to the beneficiaries for their economic activities. The women start a business and manufacture many products however due to lack of marketing facilities and lack of periodical markets they are not able to sell the goods. For selling their goods and services they have to travel from villages to villages and from the villages to the urban markets. This is a major hurdle in the progress of Swarnajayanti Gram Swarojgar Yojana (SGSY). Therefore, it is suggested that the consumer marketing facilities should be provide by the Panchayat Samitte and Zilla Parishad.

### Reference

1. Bhoomitra Dev, "Dynamics of Integrated Rural Development"
2. Das D.D., "Dynamics of Rural Development", Deep and Deep Publication, New Delhi- 1994.
3. Dr. Dhar P.K., "Indian Econoy- Its Growing Dimensions", Kalyani Publication, New Delhi 2000.
4. Dr. Sharma K.K. and others, " Intellectuals Sandharbh Maharashtra" ( State and District At a Glance) Volume I, Intellectuals Book Bureau Bhopal, 2004.
5. "Guidelines for implementation of SGSY" Government of India, 1999.
6. Research, Reference and Training Division; " India 2015- A Reference Annual", Ministry of Information and Broadcasting Government of India- 2003

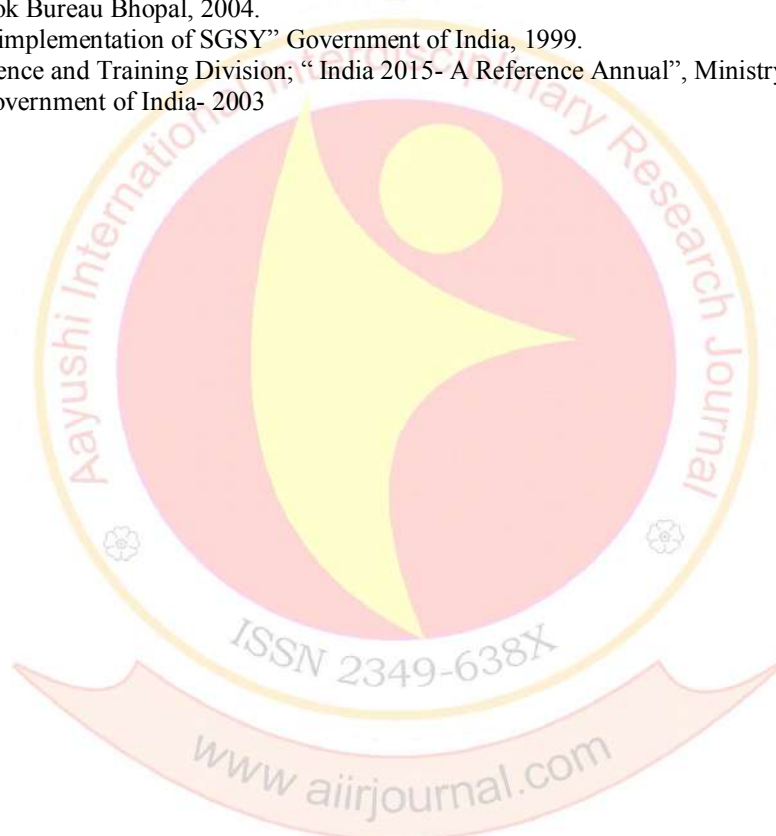



## Climate Change and its Impact on Agriculture

Suresh V. Ingale

M.A. M. Phil - Warana Mahavidyalaya, Aitawade Khurd.

### Abstract:-

Now a day's Global warming it is important problem of the world. Climate change and variability are concerns of human being. Climate change is a change in the long-term weather patterns that characterize the regions of the world. The term "weather" refers to the short-term (daily) changes in temperature, wind, and/or precipitation of a region. In the long run, the climatic change could affect agriculture in several ways such as quantity and quality of crops in terms of productivity, growth rates, photosynthesis and transpiration rates, moisture availability etc. Climate change is likely to directly impact food production across the globe. Increase in the mean seasonal temperature can reduce the duration of many crops and hence reduce the yield.

The consequences of agriculture's contribution to climate change, and of climate change's negative impact on agriculture, are severe which is projected to have a great impact on food production and may threaten the food security and hence, require special agricultural measures to combat with. Index Terms-Climate change, Greenhouse Effect, Greenhouse gases, Global Warming Potential, Inter Governmental Panel on Climate Change, parts per million. In this research paper explanation about climate change and agriculture issues and a few solutions for sustainable agriculture in India.

### Introduction:-

Climate change is a change in the long-term weather patterns that characterize the regions of the world. Climate change is any significant long-term change in the expected patterns of average weather of region. These changes may take tens, hundreds or perhaps millions of year. But increased in anthropogenic activities such as agriculture, change in land use pattern, industrialization, urbanization, deforestation, etc. leads to emission of green house gases due to which the rate of climate change is much faster.

Thus the Climate change scenarios include higher temperatures, changes in precipitation, and higher atmospheric CO<sub>2</sub> concentrations. There are three ways in which the Greenhouse Effect may be important for agriculture. First, Increased atmospheric CO<sub>2</sub> concentrations can have a direct effect on the growth rate of crop plants and weeds.

Secondly, CO<sub>2</sub>-induced changes of climate may alter levels of temperature, rainfall and sunshine that can influence plant and animal productivity. Finally, rises in sea level may lead to loss of farmland by inundation and increasing salinity of groundwater in coastal areas.

### Objectives:-

1. To study the impact of climate change on agriculture in India.
2. To make solutions or suggestions for the agriculture in India.

### Methodology:-

Climate change is likely to directly impact food production across the globe. Increase in the mean seasonal temperature can reduce the duration of many crops and hence reduce the yield. The study includes climate change and agriculture problems and issue. As well as it includes appropriate framework regarding for agriculture.

The present research paper is based on secondary data. The data has been furnished from the related articles, research papers, various books, reports and reports of the government of India. Some data has furnished from the websites of the government of India, as well as ministry of agriculture, related to climate change and agriculture.

### Indian scenario of climate change:-

The warming may be more pronounced in the northern parts of India. The extremes in maximum and minimum temperatures are expected to increase under changing climate, few places are expected to get more rain while some may remain dry. Leaving Punjab and Rajasthan in the North West and Tamil Nadu in the South, which show a slight decrease on an average a 20 percent rise in all India. Summer monsoon rainfall over all states are expected. Number of rainy days may come down (e.g. MP) but the intensity is expected to rise at most of the parts of India (e.g. North East).

Currently the districts of Jagatsinghpur and Kendrapara in Odisha; Nellore and Nagapattinam in Tamilnadu; and Junagadh and Porabandar districts in Gujarat are the most vulnerable to impacts of increased intensity and frequency of cyclones in India (NATCOM, 2004). The past observations on the mean sea level along the Indian coast show a long-term (100 year) rising trend of about 1.0 mm/year. Thus, climate change

its adversely impacting associated biodiversity, regional climate dynamics as well as livelihoods based on forest products also.

### **Impact of Climate Change on India's Agriculture:-**

India's agriculture is more dependent on monsoon from the ancient periods. Any change in monsoon trend drastically affects agriculture. Even the increasing temperature is affecting the Indian agriculture. In the Indo-Gangetic Plain, these pre-monsoon changes will primarily affect the wheat crop (>0.50C increase in time slice 2010-2039; IPCC 2007). In the states of Jharkhand, Odisha and Chhattisgarh alone, rice production losses during severe droughts (about one year in five) average about 40% of total production.

A 1oC increase in temperature may reduce yields of wheat, soybean, mustard, groundnut, and potato by 3-7%. Much higher losses at higher temperatures. Productivity of most crops to decrease only marginally by 2020 but by 10-40% by 2100 due to increases in temperature, rainfall variability, and decreases in irrigation water. The major impacts of climate change will be on rain fed or un-irrigated crops, which is cultivated in nearly 60% of cropland. A temperature rise by 0.50C in winter temperature is projected to reduce rain fed wheat yield by 0.45 tonnes per hectare in India

Increased droughts and floods are likely to increase production variability Recent studies done at the Indian Agricultural Research Institute indicate the possibility of loss of 4 -5 million tons in wheat production in future with every rise of 1oC temperature throughout the growing period. Rice production is slated to decrease by almost a tonne/hectare if the temperature goes up by 2o C. In Rajasthan, a 2oC rise in temperature was estimated to reduce production of Pearl Millet by 10-15%. If maximum and minimum temperature rises by 3oC and 3.5oC respectively, then Soyabean yields in M.P will decline by 5% compared to 1998. Agriculture will be worst affected in the coastal regions of Gujarat and Maharashtra, as fertile areas are vulnerable to inundation and Salinization.

### **Crop Response to expected Climate Change Factor:-**

Climate change scenarios include higher temperatures, changes in precipitation, and higher atmospheric CO<sub>2</sub> concentrations which may affect on yield (both quality and quantity), growth rates, photosynthesis and transpiration rates, moisture availability, through changes of water use (irrigation) and agricultural inputs such as herbicides, insecticides and fertilizers etc.

Environmental effects such as frequency and intensity of soil drainage (leading to nitrogen leaching), soil erosion, land availability, reduction of crop diversity may also affect agricultural productivity. An atmosphere with higher CO<sub>2</sub> concentration would result in higher net photosynthetic rates (Cure & Acock 1986, Allen et al. 1987). Higher CO<sub>2</sub> concentrations may also reduce transpiration (i.e. water loss) as plants reduce their stomatal apertures, the small openings in the leaves through which CO<sub>2</sub> and water vapor are exchanged with the atmosphere. The reduction in transpiration could be 30% in some crop plants (Kimball 1983). However, stomatal response to CO<sub>2</sub> interacts with many environmental (temperature, light intensity) and plant factors (e.g. age, hormones) and, therefore, predicting the effect of elevated CO<sub>2</sub> on the responsiveness of stomata is still very difficult (Rosenzweig & Hillel 1995).

Increased CO<sub>2</sub> levels may also cause a direct inhibition of maintenance respiration at night temperatures higher. In rice, extreme maximum temperature is of particular importance during 3 flowering which usually lasts 2 to 3 weeks. Exposure to high temperature for a few hours can greatly reduce pollen viability and, therefore, cause yield loss.

Significant genotypic variation in high-temperature induced floret sterility exists. Variation in solar radiation, increased maintenance respiration losses or differential effects of night vs. day temperature on tailoring, leaf-area expansion, stem elongation, grain filling, and crop phenology have been proposed as possible causes (Peng et al., 2004; Sheehy et al., 2005). In a recent climate chamber study, there was first evidence of possible genotypic variation in resistance to high night temperatures (Counce et al., 2005) High CO<sub>2</sub> levels and/or temperature are likely to affect crop development rates.

### **Climate Change - Mitigation and Adaptation in Agriculture:-**

1. Assist farmers in coping with current climatic risks by providing value-added weather services to farmers. Farmers can adapt to climate changes to some degree by shifting planting dates, choosing varieties with different growth duration, or changing crop rotations.
2. The overall pest control strategy should be based on integrated pest management because it takes care of multiple pests in a given climatic scenario.
3. Developing short-duration crop varieties that can mature before the peak heat phase set in.
4. Provide greater coverage of weather linked agriculture-insurance.
5. To develop a long-term land use plan for ensuring food security and climatic resilience.

6. Provide incentives to farmers for resource conservation and efficiency by providing credit to the farmers for transition to adaptation technologies.
7. Efficient fertilizer use such as optimum fertilizer dose, split application of nitrogenous and potassium fertilizers, deep placement, use of neem, karanja products and other such nitrification inhibitors, liming of acid soils, use of micronutrients such as zinc and boron, use of sulphur in oilseed crops, integrated nutrient management.
8. Participatory and formal plant breeding to develop climate-resilient crop varieties that can tolerate higher temperatures, drought and salinity.
9. Selecting genotype in crops that have a higher per day yield potential to counter yield loss from heat-induced reduction in growing periods.
10. Preventive measures for drought that include on-farm reservoirs in medium lands, growing of pulses and oilseeds instead of rice in uplands, ridges and furrow system in cotton crops, growing of intercrops in place of pure crops in uplands, land grading and leveling, stabilization of field bunds by stone and grasses, contour trenching for runoff collection, conservation furrows, mulching and more application of Farm yard manure (FYM).
11. Efficient water use such as frequent but shallow irrigation, drip and sprinkler irrigation for high value crops, irrigation at critical stages.
12. Provide more funds to strengthen research for enhancing adaptation and mitigation capacity of agriculture.
13. Intensify food production system by improving technology and input delivery system.
14. Adopt resource conservation technologies - no-tillage, laser land leveling, direct seeding of rice and crop diversification which will help in reducing in the global warming potential.
15. National grid grain storages at the household/ community level to the district level must be established to ensure local food security and stabilize prices.16. Seasonal weather forecasts could be used as a supportive measure to optimize planting and irrigation patterns.

#### Conclusion:-

Climate change, the outcome of the “Global Warming” has now started showing its impacts worldwide. Climate is the primary determinant of agricultural productivity which directly impact on food production across the globe. Agriculture sector is the most sensitive sector to the climate changes because the climate of a region/country determines the nature and characteristics of vegetation and crops. Increase in the mean seasonal temperature can reduce the duration of many crops and hence reduce final yield. Food production systems are extremely sensitive to climate changes like changes in temperature and precipitation, which may lead to outbreaks of pests and diseases thereby reducing harvest ultimately affecting the food security of the country.

The net impact of food security will depend on the exposure to global environmental change and the capacity to cope with and recover from global environmental change. Coping with the impact of climate change on agriculture will require careful management of resources like soil, water and biodiversity. To cope with the impact of climate change on agriculture and food production, India will need to act at the global, regional, national and local levels.

#### References:-

1. Adams, Richard M. , Hurd, Brian H. , Lenhart Stephanie , Leary, Neil., 1998, Effects of global climate change on agriculture:an interpretative review CLIMATE RESEARCH Clim Res, Vol. 11: 1,20,21
2. Adamo, Susana B., 2011, Slow-onset hazards and population displacement in the context of climate change.
3. Aiken, Rob., Feb. 2009, Climate Change impacts on Crop Growth in the Central High Plains, Proceedings of the 21st Annual Central Plain Irrigation Conference.
4. Cline William R., 2007, Global Warming and Agriculture: New Country Estimates Show Developing Countries Face Declines in Agricultural Productivity, Center for Global Development.
5. Eriksson,M.,Fang,J., Dekens, J., 2008,How does climate change affect human health in the Hindu Kush-Himalaya region?, Regional Health Forum –Volume 12, Number.
6. Gulatia, A.,Gupta, P., Jha, M., Sarathi, P.P. & Vishal, K. ,Impact of Climate Change, Variability, and Extreme rainfall Events on Agricultural Production and Food Security, ISPRS Archives XXXVIII8/W3Workshop Proceedings: Impact of Climate Change on Agriculture.
7. Hoffmann, Ulrich, 2011, Assuring Food Security in Developing Countries under the Challenges of Climate Change: Key Trade and Development Issues of a Fundamental Transformation of Agriculture, United Nation Conference on trade and Environment.
8. Mall, R.K, Singh, R., Gupta, A., Srinivasan, G., & Rathore, L.S., Impact of Climate Change on Indian Agriculture.
9. Pasupalak, S., Pasupalak,.S. , April-May –2009, Climate Change and Agriculture in Orissa, Orissa Review.

10. Priyadarshi , Nitish., 2009, “The Survival of Agriculture in a Destabilized Climate with special reference to India and its Jharkhand State. ”
11. Rai, Mangala., February 2010, India’s preparedness for food security in view of climate change, International Conference on Food Security and Climate Change in Dry Areas.
12. Wadood, A. & Kumari ,P., Impact of Climate Change on Jharkhand Agriculture : Mitigation and Adoption, ISPRS Archives XXXVIII-8/W3 Workshop Proceedings: Impact of Climate Change on Agriculture.
13. Wassmann, R. & Dobermann, A., Climate Change Adaptation through Rice Production in Regions with High Poverty Levels.
14. [http:// www.cgdev.org](http://www.cgdev.org)
15. [http:// www.climate.org](http://www.climate.org)
16. <http://www.downtoearth.org.in/content/climate-change-threatfood-produce-india-says-study>
17. <http://www.ipcc.ch/pdf/assessmentreport>
18. <http://www.rbi.org.in/>
19. <http://www.thehindu.com/sci-tech/agriculture/article1588820.ece>
20. <http://www.un.org/apps/news/story.asp?NewsID=37953>
21. [http://en.wikipedia.org/wiki/Agriculture\\_in\\_India](http://en.wikipedia.org/wiki/Agriculture_in_India)



## Population Resource and Demographic Transition In India

**Dr. Pravinchandra D. Bhakare,**

MA, PhD, NET, SET, Assistant Professor and Head, Dept. of Geography,  
Krshna Mahavidyalaya Rethare BK, Tal Karad, Dist Satara, 415108

### Introduction

Almost every country in the world experience stable, low and high population growth in its history. The causes or the reasons could same or different along with same or different magnitude. It is of vital importance to examine the relative performance of developing country like India and developed countries in the world. The objective of this paper is to examine and explain the responsible factors of uneven population growth in a cyclic form in a developing country like India.

### The Concept Of Demographic Transition

In the history of every country in the world the cycle of demographic transition takes place in a three stages i.e. Pre-Transitional Stable Population Growth, Transitional High Population Growth and Post-Transitional Stable Population Growth.

The first stage i.e. Pre-Transitional Stage of High Population Growth is attributed to the agrarian peasant economy characterized by high birth and high death rates. The death rate usually fluctuates in response to the variation in harvests, the incidents of epidemics, poor diet, primitive sanitation and inadequate medical and public health programs. The birth rates are high only because of a functional response to high mortality. The ideals of prolific fertility are, therefore ingrained in social customs and beliefs which are reinforced by the economic advantage of having a large number of children.

The second stage began occur with modernization, improved public health, better diet, and higher income which leads to a marked reduction in mortality that gradually raised life expectancy of the people. However, the decline in death rates is not immediately accompanied decline in fertility. The agrarian society starts undergoing changes and becomes interdependent on other economics which are having high level of production, highly industrialized, market oriented and urbanized. In this situation the death rates register striking reductions which is a consequence of better and regular supply of food along with improved medical knowledge. The acceptance of small size family comes initially in the higher income groups of urban areas and then spreads towards lower income groups of the small cities and eventually to rural areas. As a result, the growing divergence high birth rates and falling death rates lead to sharp increase in population growth (Population Explosion) ever in the history.

Final and third stage i.e. Post-Transition Stable Population Growth entered with the influence of modernization and development in every sector of the society and causes decline in the fertility. The falling birth rates converging with lower death rates leading to very little or almost no population growth.

### Demographic Transition In Developed and Developing Countries

This cycle of demographic transition is the general historical experience of almost every developed country in the world. In case of developing countries this transition is stopped at the second stage with spread of modern technology in every field of society. As a result the death rates, particularly infant mortality is declined significantly and rising birth rates resulted in population explosion. But the positive thing is that the selected developing countries recorded a declining trend of population growth.

As far the developed countries especially European Countries are concerned international migration played a dominant role in reducing the surplus population by encouraging migration to New World like America, Australia and other Colonial States. The migration took place on permanent basis reducing the population pressure on homelands and developed countries got rid of the surplus population and unemployment. Finally when the stage of development was attained the third stage of demographic transition was set in with stable population growth.

Population growth in developing countries is never crossing the second stage of demographic transition. In the last 60 years (1950-2010) world population has increased three times to attain above 6 billion marks. More shocking is that 3/4 of total world population is living in developing countries adding 80 million people every year. Wide spread poverty, early marriages along with very poor conditions in income, employment, health, education and social services etc. In the absence of outmigration the population growth is increasing with alarming rate in these countries.

### Demographic Transition In India

The data for India reveals high population growth in spite of population controlling measures implemented over a years. The table no 1 shows the decennial actual population and population growth rate

increasing continuously over a period of time with only exception of 1921. From 1931 to 1971 population increased with alarming rate. From 1981 population is increased but the rate of increase showing declining trend. It is very clearly seen that India is still in the late second stage of demographic transition with declining but high growth rate.

### Population growth in India.

Decades	India		
	Total Population	Decadal Growth	
		Absolute	Per cent
1901	238396327	-	-
1911	252093390	13697063	5.75
1921	251321213	-772177	-0.31
1931	278977238	27656025	11.00
1941	318660580	39683342	14.22
1951	361088090	42427510	13.31
1961	439234771	78146681	21.64
1971	548159652	108924881	24.80
1981	683329097	135169445	24.66
1991	844387888	161058791	23.57
2001	1027015247	182627359	21.63
2011	1210854977	183839730	17.64
2019	1362655864	151800887	12.53

#### 1) Pre-Independence Period (Pre-Transition Stage)

During 1901-11, growth rate of population increased very sluggishly for India, Maharashtra and Pune Division. The growth rate of population was only 0.56 per cent for Pune Division and 5.75 per cent for India while Maharashtra showed slightly high population growth *i.e.* 10.74 per cent.

All the decades in the pre-independence period, except the decade 1911-21, showed positive population growth, 1911-21 this decade is known as a great distinctive decade in Indian census, because only this decade demarked the population growth in the negative manner during last century for all the three hierarchical regions. The growth rate of population for India was dropped down up to -0.31 per cent, while Maharashtra registered slightly higher drop rate in the population growth *i.e.* -2.91 per cent, while Pune Division recorded the lowest population growth *i.e.* -4.14 per cent during this decade. This is due to abnormal mortality related to epidemics like Plague, Cholera, Malaria, Influenza, along with famines and other natural calamities caused negative growth rate in population.

Again, during 1921-31, the population growth showed positive trends for India, Maharashtra and Pune Division. In the inter-censal period, 1921-31 up to 1941-51, all these decades showed increase in the growth rate of population with very sluggish rate, particularly below 20 per cent. In 1921-31, the rate of population growth for India was 11.0 per cent, for Maharashtra it was 14.91 per cent and for Pune Division it was 15.85 per cent. Pune Division recorded the highest figure of population growth as compared to those of the state and the nation.

Some variations were observed during the decade 1931-41 in the growth rate of total population. As compared to that of the previous decade, the growth rate increased for India from 11.0 per cent to 14.22 per cent, whereas Maharashtra and Pune Division recorded slight decrease in the growth rate than that of the previous decade. The growth rate of population for Maharashtra decreased from 14.91 to 11.99 per cent; similarly, Pune Division stayed at 14.62 per cent with slight decrease from earlier decade *i.e.* 15.85 per cent.

#### 2) Early Post-Independence Period (Transition Stage)

In the early post-independence period, the growth rate of population as usual positively increased due to the liberal policies of the nation. During 1941-51, the growth rate of population showed sluggishness for all the regions except Pune Division. Pune Division recorded highest growth rate (23.93 %) and reached first time for above 20.0 per cent. Maharashtra state also recorded 19.27 per cent growth rate, which was more than that of the previous decade, while India showed only 13.31 per cent increase in the growth rate of total population and more surprisingly it was lower than that of the earlier decade, which can be attributed to social, political and economic changes.

1951-61 decade also showed contrasting trends in population growth for India, Maharashtra and Pune Division as like earlier two decades. From this decade to the last decade of the century, the rate of population growth was more than 20 per cent regularly. The declined death rate and relatively high birth rate, illiteracy

and economic backwardness affected natural growth of population. India recorded growth rate of 21.64 per cent and for Maharashtra; it was 23.60 per cent although Pune Division recorded a growth rate of 23.70 per cent, which was almost the same as compared to that of the state.

The decade 1961-71 was again also an out character decade in Indian census. As the rate of population growth is considered, this was the 'peak decade' right throughout the century. The highest rate of population growth was observed in this decade, throughout the investigation period (1901-2001) for all the three hierarchical regions, due to very rapidly declining death rate and improvement in food supply and medical facilities. India committed 24.80 per cent growth rate, likewise Pune Division recorded 25.19 per cent of growth rate of population. The highest rate of population growth was committed by Maharashtra, which was 27.45 per cent, which was quite higher than any other regions and any decade during the period of investigation.

### 3) Late Post-Independence Period (Post-Transition Stage)

In the late post-independence period, the growth rate of population also stayed at above 20 per cent as like the early post-independence period. From 1971-81 to the end of the century, increase in actual population was observed but the rate of population growth declined significantly for India, Maharashtra and Pune Division. Birth rate was declined as a consequence of improved socio-economic conditions, living standards, literacy level, life expectancy, and medical facilities due to which the rate of increase was declined. During 1971-81, growth rate of population for India was 24.66 per cent and for Maharashtra, it was almost similar (24.54 %), Pune Division showed the lowest rate of population growth (22.37 %) as compared to those of India and Maharashtra.

In the decade 1981-91, again the population growth rate declined as compared to the earlier decade except that of Maharashtra. India had 23.57 per cent population growth while Pune Division recorded near about 25.0 per cent population growth in this decade. Only Maharashtra state showed highest growth rate during the decade (25.73) as compared to the growth rate of previous decade itself, because in this decade many people from the other states migrated towards Mumbai in search of jobs and livelihood.

1991-2001 was the last decade of the investigation period. During this decade, India somehow started to achieve respectable position in the globalisation and it influenced the economic development of the country as well as per capita income. The socio-cultural status of the people reached at quite high due to increasing literacy level, specifically female literacy, therefore, birth rate also declined with declining death rate. As a result, it was affected the rate of population growth and it went down.

### Conclusion

Above discussion put forth the fact that the developed countries like India are already over populated and the trend never going to stop in the near future. More importantly there is a very little scope for reducing the pressure of growing population because these countries already have very large size of population and restrictive nature of migration laws are posed in the developed countries. The brain drain from developed countries represents not only human resource loss but could prove to be a serious constraint on the future economic progress of these countries. The serious problem of these developing countries is how to accommodate these millions of unskilled peoples having perpetual poverty and underemployment. It may thus concluded that in the presence of restricted international migration the only viable solution is the reduction in fertility, overcoming poverty and unemployment through effective policies and awareness in the people about reduction in fertility.

### References

1. Bose, A., Mitra, A., Desai, P. and Sharma, J. (1974): "Population in India's Development, 1947-2000", Vikas Publishing House Pvt. Ltd., New Delhi
2. Chandana, R. C. and Sidhu, M. S. (1980): *Introduction to Population Geography*, Kalyani Publishers, New Delhi.
3. Chandna, R. C. (1986) : *Geography of Population – Concept, Determinants and Patterns*, Kalyani Publishers, New Delhi, p.100
4. Ramchandrudu, G. and PrasadaRao, M. (2004): *Census 2001 and Human Development in India*, Serials Publications, New Delhi.
5. Sawant, N. R. (2001): "Goa: A Study in Population Geography", an Unpublished Ph. D. Thesis, submitted to The University of Pune.
6. Sharma, P. R. (1978) : "Spatio-Temporal Patterns of Population Growth and Distribution – A Regional Analysis", *The Deccan Geographer*, Vol. XVI, NO.1, p.373
7. Singh, R. N. and Chaturvedi, R. B. (1983): "Dynamics of Population in Bundelkhand Region: A Case Study", *Journal of Association of Population Geographers*, India.
8. Bhakare, P. D. (2011): "Spatio-Temporal Changes In Population Structure of Pune Division of Maharashtra" Shivaji University, Kolhapur. Unpublished Ph. D. Thesis. Chapter no iv Population Growth.
9. Census of India, 1971, 1981, 1991, 2001, 2011.

## Assessments of Drinking water quality of Ichalkaranji City and suburban area of Kolhapur District in Maharashtra State: A Geographical Inquiry.

**Prof. V.G. Sawant**

Assi. Professor, Dept. Of Geography  
Y.C.Warana, Mahavidhyalaya, Kolhapur.

### Abstract:

*Water is an essential unique universal solvent needed for any living organism. Life is not possible on this planet without water. Drinking water quality is directly related to health. The world's thirst for water is likely to become one of the most pressing issues of the 21st century. The present study was conducted for different (12) water quality parameters, for five water samples collected from different sources (bore, open well and tab water etc) basing on the consumption level of the Ichalkaranji City of Kolhapur District in Maharashtra State, for their physico-chemical parameters. The analysis include physical and chemical parameters are pH, EC, Turbidity, Hardness, TDS, F, DO, Mg, Cl, Ca, No<sub>3</sub>, SO<sub>4</sub> etc. On comparing the results against the drinking water quality standards lead by BIS (ISO:100500,1994) and WHO, It was observed that the parameters, Total solids, Electrical conductivity and turbidity was higher than the prescribed limits while other parameters were lower than the limits. The results showed that, the water in this area is not safe and needed treatment before it is consumed by the local people of the city.*

### Introduction

Water is essential for survival. In many parts of the world today ground water is the only source of fresh water where surface waters are either absent or polluted (Haniffa et al., 1993). Man's continual existence depends very much on its availability (Lamikanara 1999, FAO 1997). The provision of portable water to the rural and urban population is necessary to prevent, health hazards (Leno 2002). Before water can be described as potable, It has to comply with certain physical, chemical and micro biological standards, which are designed to ensure that the water is palatable and safe for drinking. Potable water is defined as water that is free from diseases producing micro-organisms and chemical substance deleterious to health. In present study, water is obtained from sources such as tabs, wells and bores. A supply of safe drinking water is needed for human development, health and well being. Chemical contamination of drinking water is often considered a low priority than microbial contamination by regulators, because adverse health effects from chemical contamination are generally associated with long term exposure, where the effects from microbial contamination is usually immediate (WHO, 2007) Raj Pramukh et al., (2004) emphasized that safe drinking water could make tremendous impact on the quality of life in many villages, because availability of safe drinking water has a direct impact on the working conditions and health of the people and their productive capacity.

### Objective

The main objectives of the study include:

1. To assess the quality of drinking water consumed by local people by Physical, Chemical parameters.
2. To find the possible impacts of water pollution.

### Study Area

For the present study, Ichalkaranji city of Kolhapur district of Maharashtra state is selected for the present investigation. Geographically Ichalkaranji city is 29 kms east from Kolhapur and 9.66 km south east from Hatkanangale. This city is extended from 16<sup>07'</sup> North latitudes and 74<sup>047'</sup> East longitudes. The total geographical area of city is 27. 52 sq. km. This city has situated on the banks of the River Panchaganga. The City is growing rapidly and now merging with neighboring Jaysingpur town to form a large satellite suburban township with Sangli city which is just 24 km. away.

As per provisional reports of Census India, population of Ichalkaranji in 2011 is 2,87,570 of which male and female are 1,49,691 and 1,37,879 respectively. Although Ichalkaranji city has population of 2,87,570 its urban and metropolitan population is 3,25,709 of which 1,69,870 are males and 1,55,839 are females. According to the 2011 census estimate the population of the city is 287,570, making it the 151<sup>st</sup> most populous city in India. The city's population as shown above is excludes newly developed industrial and residential areas, villages that have been annexed by Ichalkaranji (known as part of the city) but having Grampanchayat such as Kabnur, Yadrao and Korochoi etc. Village Shahapur, Ichalkaranji was included in Ichalkaranji Municipal Council in 1985. Considering this city's metropolitan population is over 3 lakh. Marathi is the official language. Marathi is spoken widely in the city. Other languages used are Kannada, Hindi and Gujarati.



It has become one of the leading centers of textile industry followed by power looms, weaving, bleaching and dying. It is now a prominent city on the textile map of India. Ichalkaranji City is known for its export of Textile goods and textile manufacturing industry. That's way this city is known as the "*Manchester of Maharashtra*". It has about 25 yarn units with about 1.25 lakh power looms, 20,000 semi-automatic looms and 7,000 Shuttle-less looms, numerous power and hand processing houses. Engineering is the second largest industry in the city. There is much progressive agriculture in the area surrounding the city.

## Research Methods:

### 1. Sample Collection

Water samples were collected from Open wells, bore wells and tab water at different area of study region. The samples are obtained according to the consumption of the local people. Samples were collected in a clean plastic can of 2 lit capacities for physicochemical analysis, the samples collected and serves as a representative sample. The collected samples were transferred to the laboratory by following all the precautions laid by standard methods (APHA, 1995). Temperature, Electrical Conductivity PH, DO were determined within the field of collection, the other parameters like TDS, Ca, Mg, NO<sub>3</sub>, SO<sub>4</sub>, Chlorides, Fluorides etc. were analyzed in the laboratory within the stipulated period. Physical and Chemical parameters are analyzed as per the standard method assessment of Ground water quality prescribed in standard method for the examination of water and wastewater American public health association (APHA 1995)

**Table No. 1 Sample Location and Samples Collected**

Sr. No.	Name of Sample Area	Sample Code	Main Source of Drinking Water
1	Ichalkaranji	S <sub>1</sub>	Tab Water
2	Village Shahapur	S <sub>2</sub>	Tab Water
3	Village Yadrao	S <sub>3</sub>	Open Well
4	Village Kabnur	S <sub>4</sub>	Open Well
5	Village Korochi	S <sub>5</sub>	Bore Well

Source: Based of field Survey, 2018.

### 2. Analysis

A total of 5 samples were collected from Oct 2018 respectively in Table NO.1. The temperature was determined using a mercury thermometer (TensonDelux make) on the spot, and the pH was measured by pH meter (Elico make) Electrical conductivity was measured by using a digital conduct meter (systronic make). The conductometre was calibrated using 0.1 N KCL solutions and (systematic make) Nephlo/Turbido meter was used for turbidity determination. The samples are also analyzed for TDS, Total hardness, nitrate (NO<sub>3</sub>), calcium, Mg, chloride by using Titration methods. DO was determined by WINEUR'S Iodometric method. The Fluoride was determined by SPADAN'S Spectrophotometric method. Turbidimetric method was employed for the estimation of sulfate (SO<sub>4</sub>), nitrate amount was derived by using the phenol disulphonic acid method. All the results were compared with the BIS (ISO-100500, 1994) and WHO standards for drinking water quality.

### Result and Discussion

The result and comparison of sample parameters with the WHO and BIS standards of drinking water quality are presented in the following table: 2

**Table No. 2 Drinking water quality**

Sr. No.	Parameters	S <sub>1</sub>	S <sub>2</sub>	S <sub>3</sub>	S <sub>4</sub>	S <sub>5</sub>	ISO(10500:2004) (Desirable limit)	WHO (Maximum allowable limit)
1	PH	6.0	6.2	7.4	7.1	6.9	6.5-8.5	6.5-8.5
2	Turbidity	5.0	10.3	7.5	5.8	9.3	5-10	NTU
3	Conductivity	200	130	250	222	633	300-400 us/cm	-
4	Total Solids	1380	930	1350	1560	1423	500 mg/L	-
5	Total Hardness	84	52	52	92	144	300mg/L	
6	Calcium	44	40	26	24	20	75mg/L	75mg/L
7	Magnesium	40	22	36	68	24	30mg/L	50mg/L
8	Chlorides	12.7	32.7	16.5	14.6	10.9	250mg/L	250mg/L
9	Fluorides	0.79	0.87	0.64	0.74	0.84	1mg/L	1.0-1.5mg/L
10	Sulphates	0.90	0.92	1.83	1.93	0.85	200mg/L	500mg/L
11	Nitrates	BDL	0.5	BDL	BDL	0.5	-	3mg/L
12	DO	4.9	1.2	5.6	5.9	5.4	-	5.0mg/L

(Source: Based on Filed Survey: 2018)

**Results:****1. pH**

In the present study the pH recorded varied from 6.0 to 7.1 with a mean pH of 6.72. Low pH-value 6.0 was recorded in the Ichalkaranji City (tab water sample) and high pH value 7.4 was recorded in Village Yadrao (Open well sample). The maximum permissible limit of WHO is 6.5- 8.5. The pH levels were in permissible limits in all the water samples. Though pH does not have a direct effect on health, all biochemical reactions are sensitive to the variation of pH [ Jeyakumar et al., 2003]. It was observed that the relative quantities of calcium, carbonate, and bicarbonates influence the pH value of water. The water tends to be more alkaline when it possesses carbonates (Zafar, 1996; suryanarayana, 1995). The pH of all the samples was within the permissible limits of WHO.

**2. Turbidity**

The turbidity indicates clarity of water and is caused by living and nonliving suspended matter and color producing substances. The readings of the Village Shahapur (Tab water), Village Korochi ( Bore well), Village Yadrao (Open Well) were above the WHO and BIS standards with the values of 10.3NTU, 9.3NTU and 7.5 NTU respectively, Presence of suspended particles and other materials are usually responsible for high turbidity values, similarly higher turbidity values were reported by( Medudhula et al., 2012.) The soil particles may have found their way into the waters from the unstable side's thereby increasing turbidity of the water. (Garg et al., 2006). The presence of inorganic nutrients such as nitrogen and phosphorus, which may stimulate the growth of algae, also contribute to turbidity (Sawyer, et, all 2000). In the study turbidity was not within acceptable limits if BIS.

**3. Electrical Conductivity**

The amount and nature of many dissolved substances in the water influence their ability to Electric Conductivity. The recommended permissible limit for electrical Conductivity is 300 us/cm to 400 s/cm. By analyzing, 90% of the samples showed Electric Conductivity ranged from 130-633 us/cm, lower than the permissible units, except the sample in Village Korochi (Bore well) and Village Yadrao (well water) samples, respectively recorded 633 us/cms and 250 us/cms.

**4. Total Dissolved Solids**

Total dissolved solids are a measure of the combined content of all inorganic and organic substances contained in a liquid in molecular, ionized or micro granular suspended form Balachandar D. et al, (2010). The minimum values were recorded to be 930 mg /L in Village Shahapur (Tab water), whereas the maximum value of 1560 mg/L was noted in Village Korochi (Bore water). The concentration in samples that is Village Yadrao and City Ichalkaranji recorded 1350mg/L and 1380 mg/L respectively, which above the permissible limit, however high total dissolved solid is found in the bore water, are below the concentration of bore water. The low level of TDS indicates that the recharging of underground water through either rain water or by the water from nearby canals (Gupta 2009).

**5. Total Hardness**

Total Hardness (CaCO<sub>3</sub>) of all the samples were ranged between 52mg/L to 144 mg/L, and recorded total hardness, low in all samples when compared with the BIS standards. The Hardness is due to the presence of calcium, Magnesium, chlorides and Sulphate Ions which range from 52- 144 mg/L. The total hardness value of Village Korochi (Bore water) was found maximum with 144mg/L and Village Shahapur (Tab water) and Yadrao (Open well) recorded minimum with 52 mg/l. The maximum permissible limits (WHO) is 300-600 mg/l Hard Water chokes water pipes deposits incrustation on utensils and increase soap consumption Nabanita Haloi (2011).

**6. Calcium**

The calcium content of the sample ranged from 20-44 mg/L. The minimum value was found to be 20 mg/L in Village Korochi (Borewell) and maximum concentration was found in tab water sample of Ichalkaranji i.e. 44 mg/L, the values were below permissible limits. Calcium may be added to water system as it passes through soil and rock containing large amounts of these elements in mineral deposits (Renn, 1970).

**7. Magnesium**

The magnesium concentration in Village Kabnur which is a well water sample is maximum and it is 124 mg/L and at Village Shahapur is tab water sample with 22 mg/L. When compared with other samples, the values of magnesium in all water samples are below the permissible limit, according to the WHO the limit is 30mg/L. Total hardness, calcium hardness and magnesium hardness were found to be below the permissible limits similar observations were recorded by Geeta (2012). Hardness has no adverse effect on human health and the water with hardness of 200mg/L may cause the scale deposition in water distribution system and more soap consumption. Water with hardness less than 100mg/L is more corrosive for water pipes (WHO 1992).

### 8. Chlorides

In the current study Chlorides ranged from 10.9 mg/L to 32.7mg/L which are below the permissible limit of 250mg/ l(BIS 1991),though chlorides below the permissible limits its presence denotes pollution hence required treatment before use. The minimum concentration was found in Village Korochi bore well i.e 10.9mg/L whereas maximum is recorded in Village Shahapur which is atab water 32.7 mg/L value when compared to other sources, when comparing the maximum concentration may be due to minerals inwell water than the surface spring water.In general chlorides occur in all types of waters contribution of chloride in ground water is due to minerals(Das and Malik1998).

### 9. Sulphates

The sulphates values were found to be below the permissible limit of 200mg/L (BIS, 1991). The minimum values were 0.85 mg/l in Village Korochi bore well water, whereas the maximum value was 1.92mg/l in Village Kabnur open well sample, may be due to dissociation of mineral content. Sulphate is the most common ion present in water. It can produce a bitter taste at high concentration. One of the occurrences of Sulphates in natural waters may be the breakdown of Organic substances in the soil (Alexander 1961).

### 10. Nitrates

Nitrates generally occur in trace level in surface waters, but may attain high levels in some ground waters one of the reasons may be application of fertilizers to lands also contribute nitrate to ground water (Peavy et al., 1986). The maximum value is 0.5 mg/L noted in Village Shahapur and Korochi and the minimum is negligible, below the detectable level,(BDL). The nitrate concentration in all the samples were below the desirable limits (BDL).

### 11. Fluorides

The presence of fluoride in drinking water is essential and WHO (1984) prescribed limits is 1.5 mg/L. The fluoride concentration in Village Shahapur which is a tab water sample was observed maximum with 0.87 mg/l where as minimum at Village Yadrao which is a open well sample with a value of 0.64 mg/L, when compared with the other samples. Fluoride concentration of 1mg/l in drinking water has no biological side effects (Leone et al 1954). It can enter human body through food, toothpaste, mouth rinsers and other edible products.

### 12. DO (Dissolved Oxygen)

It is one of the most important parameter in evaluating water quality and signifies the physical and biological dealing with the water supply. The oxygen content in water samples depends on a number of physical, chemical, biological and microbiological processes (Nurchihan et al., 2009). The minimum value was noted in Village Shahapur tab water sample 1.2 mg/L, whereas maximum value was noted in Village Kabnur which is a bore sample recorded a 5.9 mg/L All the values were observed to be little above to permissible limits of the WHO standards which is 5mg/L.

### Summary and Conclusion

A total of five water samples were analysed for 12 physico- chemical parameters and resulted, the study elevated that the water in the study region was found to be below the permissible limits, in parameters like, chlorides, Total hardness, Calcium, Magnesium, Fluorides, Sulphates, Nitrates, and pH but Turbidity, Total solids, Electrical conductivity and In some extent Dissolved oxygen found above the range of permissible limit of the WHO and BIS standards.

From this study it is evident that, the concentrations of physical, chemical content in spring and well found higher than the bore water. Hence the bore water is preferred for drinking for the local tribal community than the spring and well, in the absence of other alternative sources. The particular water from its sources which high in some parameters like turbidity and Total solids may be due to mixing of surface runoffs and the silts carried, in rainy season, and this water is recommended to be treated or filtered before it is utilized for drinking .

### 8. References

1. Balachandar .D, Sundararaj P, Rytharvel MURTHY K, Kumaraswamy K.(2010),”An investigation of ground water quality and its suitability to irrigate agriculture in Coimbatore District, Tamil Nadu ,India-ANGIS Approach”. INTERNATIONAL JOURNAL OF ENVIRONMENTAL SCIENCES vol 1, No 2:176-190.
2. BIS.1992 Specification for drinking water IS 10500:1991.Edition 2.2 Bureau of Indian Standards, New Delhi.
3. Das, J. (2002) Studies on the potable water quality of Cuttack city, Orissa. Ph.D. Thesis, Sambalpur University.
4. Food and Agriculture Organization (FAO)1997, Annual Report on Food Quality Control.
5. Garg RK, Saksena DN ,Rao R.J.,(2006).Assessment of Physico-chemical water quality of Harsi reservoir district Gwalior, Madhya Pradesh, Journal Of Ecophyiology and occupational Health,6, pp 33-40
6. Geeta(2012).”A physico-chemical and microbial Analysis of Drinking Water in some Parts of Chinthapalli Mandal Visakhapatnam Andhra Pradesh India”. Ph.D Thesis Andhra University Visakhapatnam.

7. Medudhula.Thirupathaiiah,ch.samatha,chinthasammaiah.;Analysis of water quality using Physico-chemical parameters in lower manair reservoir of Karimnagar district,Andhra Pradesh, International Journal of EnvironmentSciences, Volume 3,No.1,2012.
8. RaoN.SandDevadas,D.J.,(2005)"Quality criteria for ground water use for development on an Area".J.APPI.Geichem., 7,9-24. "
9. WHO, 1992 International Standards for drinking water.



## Materials Used For Microbial Fuel Cell

<b>Kumbar S. R<sup>1</sup></b> <sup>1</sup> Research scholar ,VTU RRC , Belagavi	<b>Dr. Chetan Jarali<sup>2</sup></b> <sup>2</sup> Structural Technologies Division, National Aeronautical Limited, Bangalore, Karnataka	<b>Dr. D.B.Talange<sup>3</sup></b> <sup>3</sup> Professor and Head, College of Engineering ,Pune, Maharashtra
--	---	---

### Abstract—

*Microbial fuel cell is a promising technology in conversion of waste to energy and also providing green environment. In this review paper various types of materials used and how these progress has improved the performance of the material in MFC is discussed. Materials that provide improved stability and immobilization of catalysts; materials that increase the conductivity and surface area of the electrodes; and materials that aid facile mass transport like carbon, graphite and graphene are the materials which help to improve the electron transfer.*

**Keywords-** *Microbial fuel cell; Electrode materials; MFC types;*

### Introduction

A fuel cell converts the chemical energy of a fuel into electrical energy without any combustion. It is a type of electrochemical fuel cell in which the organic matter found in waste water is oxidized by microorganisms. A conventional MFC is consisting of anode, cathode and proton exchange membrane, which separates the two chambers. Material used for electrode and electrode design is the greatest challenge in making MFC a cost effective. Over the last decade, many improvements in biological fuel cells have been incorporated. Materials discussed are Nano materials that improve the electron transfer from the biocatalyst to the electrode surface, materials that offer greater stability and immobilization of the biocatalysts, materials that increase the conductivity, surface area of the electrodes and materials that offer superior facile mass transport. The selection of the proper electrode material is crucial for the performance of MFCs in terms of electron transfer and electrochemical efficiency. There are many studies to scale up the power production using different carbon based materials such as carbon paper, carbon felt, carbon nano tube, graphite and graphene. In addition the cathode materials should have catalytic properties for oxygen reduction. Criteria to select materials for anode and cathode are different but in general both should possess the following properties such as Surface area and porosity, Electrical Conductivity, Stability, durability, Cost and accessibility.

Microbial fuel cells (MFC) are the first and the most widely studied METs and biochemical systems. An MFC, like any typical fuel cell, comprises of anodic and cathodic chambers separated by an ion exchange membrane.

Whereas chemical or metallic catalysts facilitate substrate oxidation and reduction reactions in a fuel cell, microorganisms catalyze either of these or both reactions using electrodes as an electron acceptor or donor source in MFCs. In a two-chambered MFC, microorganisms catalyze substrate oxidation reactions in the anodic compartment as shown in (fig.1) simultaneous chemical and microbial substrate reduction reaction occurs in the cathodic compartment. Both compartments are usually separated by a proton or cation exchange membrane and are electrically interconnected through an external circuit with a resistor or load. Anaerobic substrate oxidation by microorganisms produces carbon dioxide, protons, and electrons. The protons are transferred to the cathode chamber through a separator. The electrons are transferred first to the anode and then flow to the cathode via an external circuit thereby producing electricity as the main product. These electrons finally reduce oxygen to produce water as the end product in the cathode chamber.

The reactions occurring in MFCs can be shown as below.

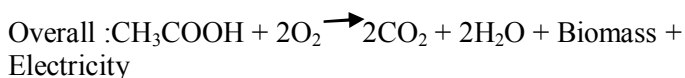
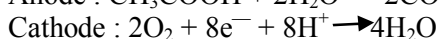
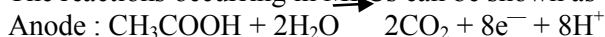
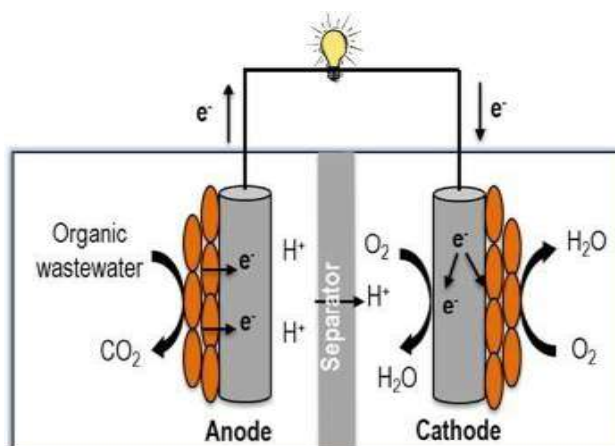

Fig. 1 A two-chambered microbial fuel cell.



## Literature Review

### A. "New materials for biological fuel cells" Shelley D. Minter & Plamen Atanassov.

In this paper the author has discussed about nano materials that improve electron transfer viz Carbon black, carbon nano tubes, graphite and grapheme are carbon based materials which are responsible for electron transfer. Carbon black Nano materials are widely used to fabricate enzyme functionalized electrodes as they possess characteristics well suited to biological interface that is high porosity and relatively high surface area coupled with high conductivity. Carbon Nano tube provides good architecture well suited to fuel cells, sensors and bioelectronics. CNT are used to increase the surface area of electrodes, to improve the conductivity of porous scaffolds for bio film growth or to increase direct bioelectrocatalysts for enzyme architectures. Graphene the current density of grapheme increases the power density by 3 times greater than the SWNT fuel cell. In regards to the nano materials for improving electron transfer, it is concluded that grapheme has found more application in the development of microbial fuel cells.

### B. "Carbon electrodes in microbial fuel cell" Arun Govind.

In this paper author has discussed various type of carbon materials and also their usage for anode and cathode.

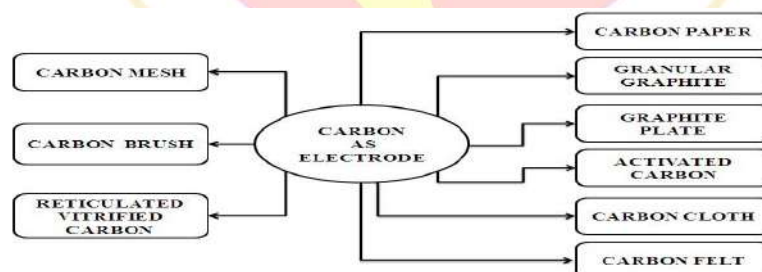

Fig1: Representation of different types of carbon electrode

Electrode material	Size	Bacterial source	MFC Type	Power output	References
Carbon brush	4cm by 3cm dia	Pre accumulated bacteria from active MFC	Cube air cathode	2400mW/m <sup>2</sup>	Logan et al.(2007)
Graphite plate	155cm <sup>2</sup>	Shewanellaoneid enis(MR-1)	Two chamber air cathode	1410mW/m <sup>2</sup>	Dewan et al.(2008)
Activated carbon cloth	1.5cm <sup>2</sup>	D.desulfuricans strain	Single chamber air cathode	0.51mW/m <sup>2</sup>	Zhao et al.(2008)
Carbon Mesh	7cm <sup>2</sup>	Pre accumulated bacteria from active MFC	Single chamber cube air cathode	893mW/m <sup>2</sup>	Wang et al.(2009)

Table1. Carbon as an anode, Power output.

Electrode material	Size	Catalyst	MFC Type	Power output	References
Carbon cloth/naflon binder	7cm <sup>2</sup>	Pt	single chamber cube Air-cathode	480mW/m <sup>2</sup>	Cheng et al.(2006)
Carbon fiber felt	36cm <sup>2</sup>	-	Cylindrical two chamber Aqueous air-cathode without catalyst	315mW/m <sup>2</sup>	Deng et al.(2010)
Carbon cloth PTFE binder	7cm <sup>2</sup>	Pt	single chamber cube Air-cathode	360mW/m <sup>2</sup>	Cheng et al.(2006)
Graphite coating on ultrafiltration (UF) membrane	54cm <sup>2</sup>	CoTMPP	Tubular Single chamber	18W/m <sup>2</sup>	Zuo et al.(2007)

Table 2. Carbon cathode electrode, MFC type, catalyst and power output.

Table 1 shows a detailed analysis of Carbon electrode used and their sources to the power output of the corresponding combination, which represents Electrode as anode. From this paper usage of carbon electrode effectively in various type of MFC is discussed also reduction of cost on electrode by replacing with low cost material without compromising MFC performance and type of MFC used in power generation and effective design aspects in MFC for maximum power output with less manufacturing difficulties are discussed. Dewan et al. found that power densities scale with the logarithm of the projected surface area. (Logan et al.) Showed that increasing the overall surface area by employing a graphite electrode brush increased current density by ~2.5 times compared to a carbon cloth anode. Table 2 shows that different type of catalyst used in the system and their respective power output which represents electrode as cathode. At the same time however, Dewan et al. found that current densities for electrodes with a larger surface area cannot always be directly extrapolated using the current densities generated by smaller electrodes.

### C. “Electrode materials for microbial fuel cells: nanomaterial approach” Mustakeem

In this paper author has discussed electrode materials have a great impact on the performance of MFCs. Since cathodes and anodes have different characteristics, the materials and design for them also differ. In general, electrode materials are considered in terms of surface area, electronic conductivity, chemical stability, cost and accessibility. In the future, microorganism can be manipulated to increase their endogenous mediators for improved electron transfer.

### Conclusion

This review illustrates the usage of carbon electrode effectively in various type of MFC is discussed, which have a enormous impact on the performance of MFCs. Carbon based materials are used because of their high conductivity, biocompatibility and low cost are widely used. In this paper also refer to the reduction of the cost on the electrode by replacing low cost material without compromising MFC performance.

### Acknowledgment

I would like to express my deepest appreciation to Mr. Anil Rao, for providing guidance. A special gratitude I give to Dr. Chetan Jarali and Dr. D.B. Talange, for their contribution in stimulating suggestions and encouragement, helped me to coordinate my project especially in writing this report.

### References

1. Shelley D. Minter, Plamen Atanassov, Heather R Luckarift, and Glenn R. Johnson, “New materials for biological fuel cells,” Journal titled Materials today
2. April 2012 Volume 15, Number 4.
3. Arun Govind M, “Carbon electrodes in Microbial Fuel cell,” International research Journal of Engineering and Technology Volume 02 ,Issue ;08 Nov 2015 pp. 424-427.
4. Mustakeem “Electrode materials for microbial fuel cells: nanomaterial” in springer on 5th November 2015.

**Advanced NCs devices for Smart Lighting Purposes a new way of energy saving.****Milind G. Chikalkar**Associate Professor in Chemistry,  
Head of Department of Chemistry  
Y. C. W. M. Waranagar,**Vilas. Shamrao Patil,**Assistant Prof. in Physics,  
Department of physics  
Y. C. W. M. Waranagar,**Abstract:**

*Nanocrystals (NCs) are tiny crystals of metals, semiconductors, and magnetic material consisting of hundreds to a few thousand atoms each. Their size ranges from 2-3 to about 20 nm. The quantum mechanical coupling of over hundreds to thousands atoms is necessary to develop the band structure of metals, semiconductors, and magnetic materials. In this regime, the electronic structure, optical, sensor, thermal and magnetic properties of materials can be tuned by varying the physical size of the crystal. Super paramagnetism of magnetic NCs, surface plasmon resonance some nanoparticles shows the size dependent band gap of semiconductor NCs. Formerly, lithographic techniques aggressively invaded the nanoworld; nowadays, electronic circuits with features as small as 45 nm are used for commercial applications, with good prospects for 32 to 22 nm technologies that are on the way from laboratories to fabrication facilities. Because of similarities in feature size, the knowledge obtained from electronic studies of nanoscale materials should help in understanding the design rules for next generations of electronic circuits. Inorganic semiconductors have a proven track record in electronics and optoelectronics; they offer superior carrier mobilities, light absorption, photo, and thermal stability. However, they are difficult to form by low cost processes. The development of applications ranging from photovoltaics and light-emitting devices to "smart cards", radio frequency tags, and sensors could be accelerated by introducing lower cost alternatives to conventional technologies that rely on single crystals. Here, building blocks for inexpensive manufacturing of low cost and large area devices. Solution-based processes such as spin coating, dip coating, or inkjet printing offer substantial cost reductions for the fabrication of electronic and optoelectronic devices.*

*Plasmonic properties of noble metal NCs are utilized in molecular-specific imaging and sensing, as well as in photodiagnostic and photothermal therapy. At the same time, realizing solid-state electronic applications (e.g., field-effect devices) of these nanoscale building blocks has been more challenging. The band gap of semiconductor nanostructures can be precisely tuned by size and shape control, electron and hole can be spatially separated within the NC by introducing heterostructures with staggered band offsets, different confined regimes can be achieved for electrons and holes, etc. this research play an magical role in smart lightning.*

**Key words :** Advanced NCs devices, lightning purpose.**1. Advanced NCs devices used for Smart Lighting purpose:****1.1 Field-Effect Transistors (FETs)**

Colloidal semiconductor NCs with precisely controlled size, morphology, and chemical composition have been explored as the building blocks for thin film transistors. Potential benefits of employing colloidal NCs in FET devices include possibility of inkjet printing of active electronic circuits on flexible plastic substrates, low temperature solution processing for large area applications such as flat panel displays, etc. Among natural competitors for NCs in this area, we should mention organic electronic materials. Organic FETs have been extensively studied during the past decade and demonstrated impressive improvements of their performance. The major limitations of FETs based on organic polymers and small molecules are rather low carrier mobilities, on the order of a few  $\text{cm}^2 \text{V}^{-1} \text{s}^{-1}$  or less even for well-optimized devices. Organic FETs typically operate in p-type regime. Despite significant research efforts invested in the developments of n-type and ambipolar organic FETs, only limited progress has been achieved in terms of carrier mobility and operational stability availability of materials for stable n-type FETs is highly desired for fabrication of CMOS (complementary metal oxide semiconductor) circuits using solution-processed organic or inorganic components. In general, CMOS allows easier circuit design, greater speed, and lower power consumption than n-MOS or p-MOS circuitry alone. Other classes of materials for solution fabricated FETs include molecular precursors for inorganic semiconductors. FETs are used for advanced switching purpose.

**1.2 Nanocrystal Solar Cells**

The growing demand for renewable energy requires significant efforts to be invested in the development of efficient and inexpensive photovoltaic materials. Semiconductor NCs are considered promising candidates for photovoltaic applications due to the combination of superior optical and electronic properties of inorganic semiconductors with the opportunities for inexpensive, solution-based device fabrication. NC-based photovoltaics are probably the most desired kind of NC devices that can make a really significant technological impact. In this section, we discuss different approaches used to employ colloiddally



synthesized nanomaterials in photovoltaics, state-of-the-art developments in the field, and future perspective directions for NC-based solar cells.

### 1.3 Nanocrystal detectors as sensors

There is a large variety of sensitive photon detection systems operating in the visible spectral range: photomultiplier tubes, single crystal silicon detectors, and CCD cameras. The silicon, which is a main workhorse for CCD and APD technologies, cannot operate beyond 1.1  $\mu\text{m}$ , whereas other materials show higher noise levels or are difficult to process using standard single-crystal-based microfabrication techniques. At the same time, markets for near-IR and mid-IR detectors span from telecommunication to night-vision systems, bioimaging, environmental sensing, spectroscopy, and chemical analysis. For all of those areas, it is highly desirable to find new materials that enable high detectivity at a reasonable cost. Recent developments provide good expectations for photodetectors based on NC solids. Application of NCs for photon detection is receiving steadily growing attention.

### 1.4 NCs Devices

Examples of NC devices include photo resistors, diodes with rectifying I-V characteristic, field-effect transistors, memory elements, light-emitting and photovoltaic devices, etc. All of these have been recently assembled from chemically synthesized metal and semiconductor NCs. Among the benefits provided by this class of electronic materials, there are properties inherent to nanoscale materials such as size-dependent electronic structure, charging energy, melting temperature, and other parameters that can be finetuned by varying NC size. For example, superior luminescent properties of semiconductor NCs (size-tunable color, narrow emission band, almost 100% luminescence quantum efficiency, high stability, etc.) have been utilized in light emitting devices (LEDs).

Smart lightning uses these devices.

### 2.0 Smart Lighting:

Lighting plays an important role in our well-being and use of smart lighting system adds elegance, ambience, convenience and energy efficiency to any place. Lighting is a vital part of life at home. It makes our homes safer, cozier and more welcoming. Lighting plays an important role in our well-being and use of smart lighting system adds elegance, ambience, convenience and energy efficiency to any place. Warm, dime led light creates a calming atmosphere which encourages socializing and relaxation.

At present, incorporating smart lighting in than to think. The lots are ready right out-of-the-box, with light sources and steering devices prepared. All we need to do in install these smart bulbs. Create arrange of preset moods for all activities from weeknights cooking to weekend movie marathons, we can create a preset lightning mood to each activity by setting rise and shine we can wake gently safely brightening light. Smart lightning dimming kit white spectrum changess the room and atmosphere from reading light to dancing light back again with click on the remote control smart lightning, for instance, gives flexibility because we can control it with timers, plus can set schedules and monitor bulb status remotely, etc. There are four reasons why you should use smart lighting.

First and foremost it can save money on a utilities bill. That's because a smart lighting network is very energy efficient; it allows us to calibrate when exactly a light should be on. Smart lights can also simplify our life. When preparing to travel, we won't have to physically alter the settings of each smart light or check to see if it is off before we leave., we can do all this remotely, from a far.

### 3.0 Segments of Smart Lighting System

Smart lighting incorporates many technologies so that either indoor or outdoor lights will work automatically under certain conditions. Different smart lighting networks do different things, but some of the more popular solutions feature smart lights that are capable of instantly switching on when someone enters a room or changing colour when something occurs. Different types of smart lighting systems are available with all know how of their working, and the many products we can buy in market today.

**3.1 Home Automation:** enables to have automatic, electronic, and even remote control of the home as well as the devices, fixtures, accessories, and appliances inside. Several manufacturers have already developed smart products for homes and various control systems that enable their automation. Smart lighting networks fit into the home.

### 3.2 Smart lighting system segmented by product types, is summarized as:

Light source, communication technology and applications is summarized as follows

Product type	Light Source	Communication Technology	Protocol	Applications
<ul style="list-style-type: none"> <li>-Smart Bulbs</li> <li>-Fixtures</li> <li>-Control Systems</li> <li>-Drivers and ballasts</li> <li>-Switches and dimmers, actuators</li> <li>- Sensors</li> <li>- Microcontrollers</li> <li>-Transmitters and receivers.</li> </ul>	<ul style="list-style-type: none"> <li>- Light Emitting Diode</li> <li>- Fluorescent Lamps</li> <li>- High-Intensity -- ---Discharge Lamps</li> </ul>	<ul style="list-style-type: none"> <li>-Wired</li> <li>-Digital addressable lightning interface</li> <li>-Power line communication</li> <li>-Power over Ethernet</li> <li>- Wired Hybrid others</li> </ul>	<ul style="list-style-type: none"> <li>- Wireless</li> <li>- Zigbee</li> <li>-Enocean</li> <li>- Li-Fi</li> <li>- Wi-Fi</li> </ul>	<ul style="list-style-type: none"> <li>- Indoor lightning</li> <li>--Commercial</li> <li>- Industrial</li> <li>- Residential</li> <li>-Others - Outdoor Lighting</li> <li>- Highway &amp; Roadway lightning</li> <li>-Architectural Lighting</li> <li>- Lighting for Public Places</li> </ul>

Automation trend and will change the way of lighting our home, forever.

**3.4 Networks & Controls:** Often allow lights to interact with each other, so that they can be calibrated en masse, or even individually through a remote control setup. Smart lighting networks vary drastically, but generally, their lights can either work independently or together when connected. There are two main types of smart lighting networks: sensor-integrated and non-sensor integrated. Sensor-integrated lights feature sensors that enable them to recognise people and daylight, among other things. These lights automatically send data to the smart lighting network, which sets specific parameters for i; each light. Although non-sensor integrated lights don't have sensors, they're still considered smart, because we can program them. There are two main ways of controlling smart lights: control hubs and smart devices. We can use tablets, smart phones, laptops, and even desktop computers (as long as both the device and the smart lights are connected to Wi-Fi or Bluetooth) to remotely configure and manage smart lighting. In some situations, typically, in larger buildings, there is a dedicated control hub that maintains the smart lighting network.

**3.5. Moving Heads:**

A moving head has the ability to change colours and patterns. It has a wide range of mobility options, such as circular, pan and tilt. The newer moving heads can rotate between 360-180 degrees. They are visually more interesting to guests and offer a larger range of movement and lighting output than scanners.

**3.6 Scanners:**

Scanners also have the ability to change colours and patterns but unlike moving heads, they have limited mobility of its head. Instead, it features a moving mirror that gives the fixture the ability to project patterns and colours throughout the room. There are many debates whether scanners are better than moving heads or vice versa. Scanners are faster than moving head fixtures. However, moving heads will capture the interest of your guests with its moving function. In today's market, intelligent lighting is manufactured with LED technology.

**3.7 Role of LEDs:**

Energy savings, exciting new designs, better light quality, lower environmental impact and a 20-year lifespan; new LED lighting is so much better than old incandescent lighting. So, we've switched our entire lighting range to LEDs. This really does mean everything, from bright and accurate kitchen lighting through to warm and cozy bedroom lighting with LED bulbs for all existing light fittings. To reduce your energy consumption without making sacrifices. To make living a sustainable life at home easier, beautiful and more affordable, LEDs are an easy way to make a big difference. Energy efficiency, viability, and sustainability were the questions the LED lighting industry addressed over the last decade. With Solid-State Lighting successfully established for indoor outdoor and roadway lighting, the industry is poised to take LED to new

dimensions. Within the smart lighting market, light emitting diodes (LEDs) are expected to remain the largest market and are expected to witness the highest growth over the forecast period. Declining cost of LEDs, low maintenance, and high energy efficiency are expected to spur the growth of this segment.

#### 4. Smart Lighting cities:

Sensor technology is developing at a phenomenal rate, battery powered sensors can now last up to 10 years and be deployed in challenging locations to help deploy smart city solutions almost anywhere. Solutions such as smart lighting, where traditional legacy lights are replaced with LED lamps can generate significant savings on energy bills and maintenance costs, and deliver a potential return on investment in less than eight years. The upgraded street lighting assets can then be further used to support other Smart City initiatives such as a WiFi mesh network; smart parking and air quality monitoring. Devices that can power themselves, by tapping into sunlight, vibrations or heat, are also under development. Moving beyond the functionality of products to meaningful applications providing value for citizens and society requires a change in paradigm that affects all participants. Cities strive to improve quality of life for their the citizens and see opportunities in new information CD and 5 communication technology-based it technologies. Public lighting and rr public lighting infrastructure can play a significant role as a stepping stone to achieve the ambitions of cities to become 'smart cities'. New technologies, like LED lighting and data science, do not only contribute to energy saving, but at the same time provide opportunities for value adding services.

#### 5.0 Opportunities:

Opportunities of smart lighting are quality of lighting that addresses human health benefits, digital signage and agricultural lighting and can be summarized below.

Now it is a good time for new startups who wants to improve their city by using old technology and inventing new, in order to find smart ways of using light. There are several case studies are light has for example prevented crime, increased N number of people out, leading to more customers for local businesses and so on. Trends opportunities in the smart lighting systems arise by products (smart bulbs, fixtures, control systems), by light source (light emitting diode, fluorescent lamps, high-intensity discharge lamps, and others), by application (indoor lights and outdoor lights), by communication technology (wired and wireless) and by region. Get started with the magic of smart lighting in one room, or brighten up the entire house.

1. Smart lighting knows no boundaries-from under roof to under the stars. Activate a lighting scene that lights up the deck and emphasizes water features in the backyard. Exterior lighting can turn on-and-off in unison with the sunrise and sunset. Set perimeter lights to flash If the alarm system is triggered drawing attention to unusual activity.
2. Raise or dim light in the room entire house with a single touch, using just our voice or using remote control or Apps.
3. Customizable buttons allow you to control more than just lighting-including music, movies and more-with a simple press.
4. Having automatically to how we live. It lighting responding is not just smart, it is brilliant, With smart lighting, We can change the atmosphere in Our home with the touch of a button. Turn on/off, dim, adjust colour temperature and more from anywhere in the home without rewiring.
5. Make your house occupied while you are away. Choose a light for early mornings, another for late evenings and a third for cooking or working.
6. Wireless lighting sophisticated style provides in sleek color configurations, guaranteed to complement the beauty of your home.
7. Motion sensors provide hands-free illumination and automatically turn off lights when no one is in the room. Button customization enables one-touch control of lighting of course, but also entertainment, security, climate and more.
8. Smart lighting solution with its comprehensive capabilities can detect dusk and drawn, conserve energy and provide huge value to the customers in terms of cost-cutting and operating efficiency.
9. Sophisticated solution continuously monitor the operations of luminaries (indoors and outdoors)by a centralized monitoring system, which helps in reducing the energy consumption , maintenance and manpower cost and increasing efficiency.

**6.0 Problems:** Night shift workers have a higher cancer risk, and some scientist have suggested possible link to lightning at work that could indirectly impact cancer risk by distribution of human circadian (day-night) regulation.

There are always challenges in creating and implementing smart solutions that are truly serving the need of the people and making the places attractive to live. Emerging challenges include connectively,

interloper ability data security non- visible effects of lightning spectral and light dosage for plant and poultry growth . questions have arisen with respect to potential health implications of blue-rich , solid-state or compact fluorescent lighting. Short wavelength visible light at very high intensities can be phototoxic to retina , and the newly discovered retinal cells that influence circadian rhythm are strongly blue-sensitive.

Changing fixture and control technology carpooled with integration expectation and energy management demands leave many lightning designer hesitant to fully embrace lightning control. Relying on manufacturers and engineers for all things “controls” related , the lightning the designer can ignore a vital tool in the design and weaken their position with their clients when problem occur.. Most of us take for granted that our city lights will illuminate the streets but good quality city lightning can also create a feeling of safety , allowing citizen to enjoy life and make most of everything a city has to offer. Cities need to remain attractive and safe place for resident and visitors, to develops the centers of economic growth. But this must be balanced by the harsh reality of budget constraints and the requirement to lower carbon footprints by using fewer resources.

**7.0 Conclusions:** The future of the smart lightning market looks promising with opportunities in the residential and commercial sectors. the global smart lightning marker is expected to reach an estimates USD 17.7 billion to 2022 and the forecast to grow at a CAGR of 23.9% from 2017 to 2022. The major drivers of growth for this market are development of smart cities, increase the usage of wireless technology and increasing awareness of energy saving. Emerging trend which have a direct impact on smart lightning industry.

- 1) Klimov, V. I. J. Phys. Chem. B 2006, 110, 16827.
- 2) Klimov, V. I.; Ivanov, S. A.; Nanda, J.; Achermann, M.; Bezel, I.; McGuire, J. A.; Piryatinski, A. Nature 2007, 447, 441.
- 3) Jain, P. K.; Huang, X.; El-Sayed, I. H.; El-Sayad, M. A. Plasmonics 2007, 2, 107.
- 4) Alivisatos, A. P.; Gu, W. W.; Larabell, C. Annu. Rev. Biomed. Eng. 2005, 7, 55.
- 5) Hergt, R.; Dutz, S.; Muller, R.; Zeisberger, M. J. Phys.: Condens. Matter 2006, 18, S2919.
- 6) Jun, Y. W.; Seo, J. W.; Cheon, A. Acc. Chem. Res. 2008, 41, 179.
- 7) Laurent, S.; Forge, D.; Port, M.; Roch, A.; Robic, C.; Elst, L. V.; Muller, R. N. Chem. Rev. 2008, 108, 2064.
- 8) Clifford, J. P.; Konstantatos, G.; Johnston, K. W.; Hoogland, S.; Levina, L.; Sargent, E. H. Nat. Nanotechnol. 2009, 4, 40.
- 9) Talapin, D. V.; Murray, C. B. Science 2005, 310, 86.
- 10) Lee, J. S.; Shevchenko, E. V.; Talapin, D. V. J. Am. Chem. Soc. 2008, 130, 9673.
- 11) Law, M.; Luther, J. M.; Song, Q.; Hughes, B. K.; Perkins, C. L.; Nozik, A. J. J. Am. Chem. Soc. 2008, 130, 5974.
- 12) Murray, C. B.; Norris, D. J.; Bawendi, M. G. J. Am. Chem. Soc. 1993, 115, 8706.
- 13) Sun, S.; Murray, C. B.; Weller, D.; Folks, L.; Moser, A. Science 2000, 287, 1989.
- 14) Park, J.; Joo, J.; Kwon, C. G.; Jang, Y.; Hyeon, T. Angew. Chem., Int. Ed. 2007, 46, 4630.
- 15) Park, J.; An, K.; Hwang, Y.; Park, J.-G.; Noh, H.-J.; Kim, H.-J.; Park, J.-H.; Hwang, N.-M.; Hyeon, T. Nat. Mater. 2004, 3, 891.
- 16) Yin, Y.; Alivisatos, A. P. Nature 2005, 437, 664.A

## Structural & Optical Studies Of Nanocrystalline CdS Thin Films For Energy Saving Applications.

**Vilas. Shamrao Patil,**  
Assistant Prof. in Physics,  
Department of physics  
Y. C. W. M. Waranagar,

### Abstract

The work mainly concerns with study of the structural details, microstructure, and optical properties of the CdS thin films. The study of semiconductor nanoparticles has been an interesting field of research for more than two decades. The confinement effect is observed for CdS particles when the particle sizes are equal to or less than 50 Å. Bulk CdS is widely used as a commercial photo detector in the visible spectrum. It is also used as a promising material for buffer layers in thin film solar cells is for conversion in electricity/ voltage. The optical properties of CdS nanoparticles have been extensively studied in recent years as this material exhibits pronounced quantum size effects. Various properties like optical absorbance, dc and ac conduction behavior have been investigated in close correlation with the microstructure of the films. It involves the study of nanocrystalline CdS thin films by sol-gel spin coating deposition techniques, studying growth, microstructure, and morphology and from that correlating the microstructure to its physical and optical properties are used for energy saving appliances.

**Keywords :** morphology, microstructure, optical

### Introduction

The study of semiconductor nanoparticles has been an interesting field of research for more than two decades. This is because it gives an opportunity to understand the physical properties in low dimensions and to explore their vast potential for applications, e.g. in optoelectronics [1-4]. The latter is particularly based on the large variations of the band gap as a function of particle size, which is a consequence of quantum confinement [5-11]. Moreover, small nanoparticles allow the study of relevant surface properties due to the high surface to bulk ratio. In semiconductor nanoparticles, strong confinement effects appear when the size of the nanoparticles is comparable to the Bohr radius of the exciton in the bulk material. The confinement effect is observed for CdS particles when the particle sizes are equal to or less than 50 Å [9, 10]. Bulk CdS is widely used as a commercial photodetector in the visible spectrum. It is also used as a promising material for buffer layers in thin film solar cells [12, 13]. The optical properties of CdS nanoparticles have been extensively studied in recent years as this material exhibits pronounced quantum size effects [14, 15]. A lot of work has been done on the preparation of these nanoparticles, and a wet chemical synthesis has come up as a promising technique because of the ability to produce various sizes and large quantities of the nanoparticles [14, 16-18]. Since very small nanoparticles have larger surface to volume ratios, many properties are directly related to the particle surface. The surface properties of the nanoparticles have been studied much less than the bulk properties [19, 20], even though this information is of significant importance, and therefore many interesting aspects of nanoparticles are still not revealed.

Photoelectron spectroscopy (PES) has a great potential to probe the surface of such particles. This is because of the small inelastic mean free paths of emitted photoelectrons. Thus, in metals, where the Fermi level lies in the center of a band, the relevant energy level spacing is still very small, and at temperatures above a few kelvin, the electrical and optical properties more closely resemble those of a continuum, even in relatively small sizes (tens or hundreds of atoms)[12] In semiconductors, however, the Fermi level lies between two bands, so that the edges of the bands dominate the low-energy optical and electrical behavior. Optical excitations across the gap depend strongly on the size, even for crystallites as large as 10 000 atoms.

### 1. Structural studies

#### 1.1 X-ray diffraction

The XRD pattern of the precipitated nanoparticles was illustrated in **Fig. 1** It can be attributed to hexagonal CdS (JCPDS – file No. 10-0454). The broadened peaks are indicating that the sizes of the particles are in nanorange. In order to achieve more confirmative information, the Debye–Scherer formula [21];

$$L = 0.9\lambda / B \cos\theta = 34 \text{ nm}$$

has been applied to calculate the size of the nanoparticles. Here,  $L$  is the coherent length,  $\lambda$  is the wavelength of X-ray radiation,  $B$  is the full-width at half-maximum (FMWH) of the peak, and  $\theta$  is the angle of diffraction. In the case of spherical crystallites, the corresponding crystallite size of nanoparticles obtained in this way is 34 nm which confirms our findings in SEM image .

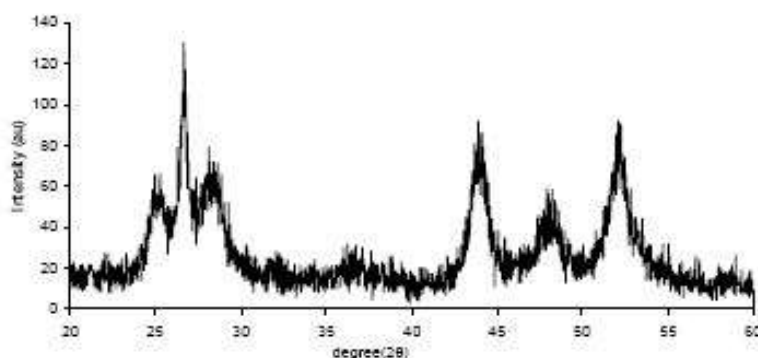

Figure 1 XRD pattern of CdS nanoparticles.

## 1.2. Transmission Electron Microscope (TEM)

Fig.2.A) TEM image of CdS triangular shaped nanocrystals. B) HRTEM of a nanocrystal. C) PS of this nanocrystals. The transmission electron microscopy (TEM) pattern [22] (Fig. 2A) shows that most of the particles are characterized by an angular shape with an average size of 10 nm. To determine the structure of isolated triangular nanocrystals, high-resolution transmission electron microscopy (HRTEM) [23] experiments and image processing by the square Fourier transform (power spectrum, PS)[24] are performed. A large collection of triangular nanocrystals is used and the data

obtained are highly reproducible. The HRTEM image of the triangular nanocrystals shows several lattice planes (Fig. 2 B). The PS shows several well defined sharp spots: the inner three pairs are characterized by an inter-plane distance of  $3.626 \text{ \AA}$ . The second order is well defined. Another series of spots corresponds to a distance of  $2.1094 \text{ \AA}$  with a  $60^\circ$  angle between the spots. These experimental data are compared with the calculated single crystal diffraction patterns [25] oriented in [111] and [001] direction for cubic (zinc blende) and hexagonal (wurtzite) structures, respectively. For the cubic phase, the first order external diffraction spots are observed. Conversely, for the hexagonal phase all the spots are present (inner and external). Table 2 compares the calculated and experimental data of the inter-planar distances and shows rather good agreement between these data. The spots corresponding to 100, 110, and 200 diffraction of the hexagonal structure (wurtzite) are shown in Fig. 2C. Hence, from this, it can be concluded that isolated triangular nanocrystals are crystallized in a wurtzite structure. The well-defined second-order diffraction spots indicate a high crystallinity of the nanoparticles. The triangular shape of PS spots (Fourier transform form factor) indicates a highly homogeneous surface. Thus, at the few-nanometer scale it can be concluded that the isolated triangular particles are highly crystallized in a hexagonal structure with a homogeneous surface. Figure 11 also shows nanocrystals having other shapes. It is difficult to know if they result from coalescence after growth or they grow like that. However, from the results obtained with other nanocrystals the tendency will be to say that they grow like that.

. Calculated single crystal diffraction for the [001] plane of wurtzite CdS with electron radiation  $k = 0.02508 \text{ \AA}^{-1}$  compared with the experimental results.

Diffraction	d calculated ( $\text{\AA}$ )	d experimental ( $\text{\AA}$ )
100	3.5861	3.626
110	2.0705	1.810
200	1.7931	1.810

Table 1

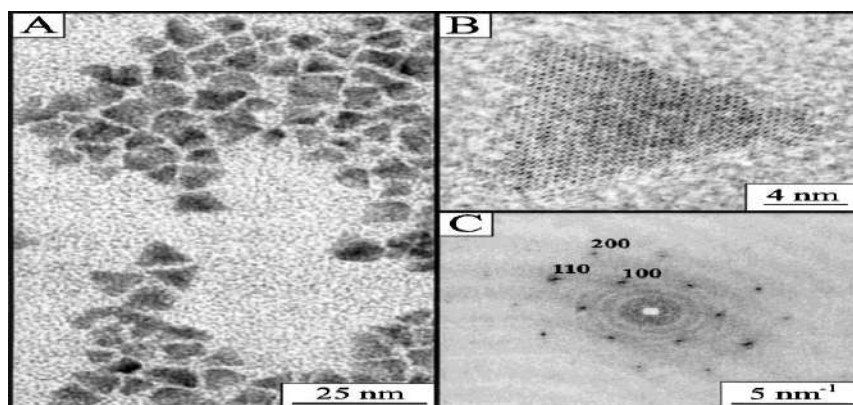

Figure 2

. A) TEM image of CdS triangular shaped nanocrystals. B) HRTEM of a nanocrystal. C) PS of this nanocrystal

## 2 Optical studies

### 2.1 Optical absorption measurements

Figure 3 shows the room temperature absorption spectra. The absorption edges of the nanocrystalline samples are observed at lower wavelengths signifying a blue shift. Figure 4 shows the size dependence of the band gap, clearly showing a blue shift with decreasing crystalline size. It is clear from the figure that a change in band gap could be achieved in the band gap from 2.405eV to 2.97eV as we narrow down the crystalline size.

It is clearly observed that at lower wavelengths nanocrystalline samples show a blue-shift. The sample (S1) is expected to be of smaller size, as it was prepared with a relatively higher proportion of the capping agent. This is supported by the shift of the absorption band edge to still lower wavelength compared to that of sample (S2). This clearly demonstrates a progressive increase of the band gap with decreasing cluster size in CdS nanocrystallites. In more qualitative terms, the sample of larger clusters (S2) has an absorption edge at 461nm (2.69eV) and another one with smaller clusters (S1) has an edge at 396nm (3.13eV). Thus the shift in the band gaps are 0.3eV and 0.73eV for clusters (S2) and (S1) respectively. These shifts corresponds to  $40\text{\AA}$  and  $20\text{\AA}$  diameter particles for these two nanocrystallite samples, when analyzed on the basis of experimental results as well as tight binding calculations reported by Wang and Herron[28]. However the excitonic feature is not pronounced in any of these samples. This may be due to a large size distribution of particles.

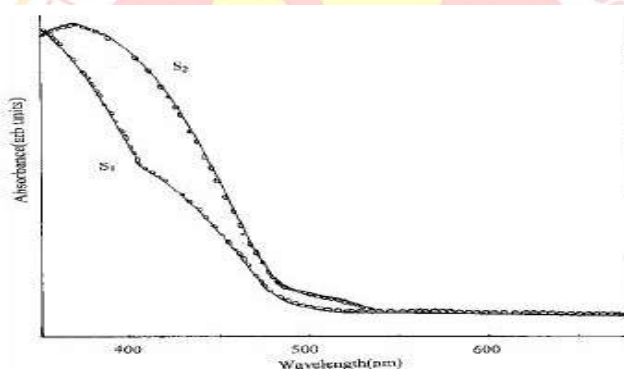

Figure 3

Room temperature absorption spectra of CdS samples.

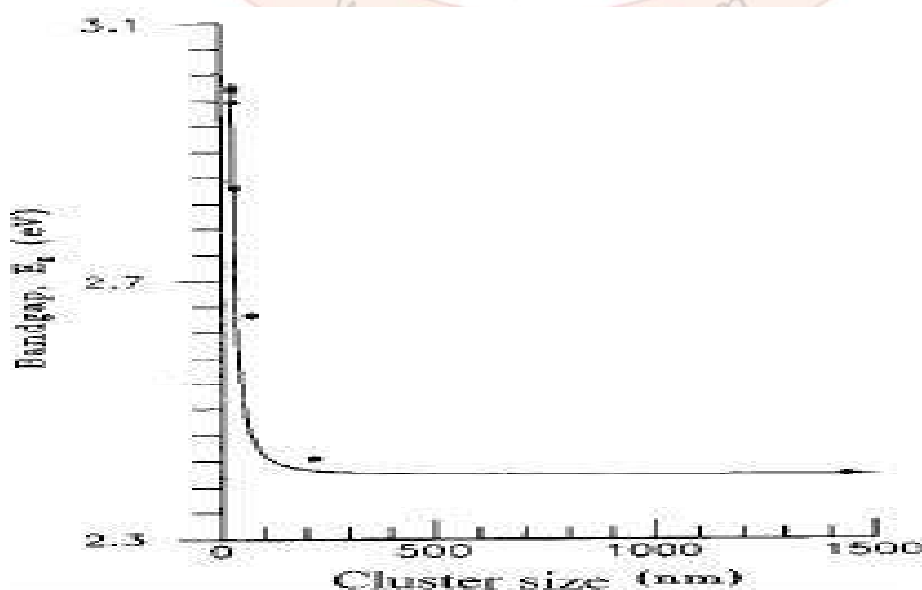

Figure 4. The size dependence of the band gap.

## 2.2. Photoluminescence measurements

Fig. 5 shows the PL emission spectrum of an absolute ethanol solution containing CdS nanoparticles that are obtained by the offered route. The pattern consists of one strong and narrow emission at 340 nm using a 220 nm excitation wavelength. The luminescence at 340 nm may be attributed to a higher level transition in CdS crystallites. It was reported that this kind of band-edge luminescence is caused by the recombination of excitons and/or shallowly trapped electron-hole pairs [24]. The apparent blue shift and the strong peak are also indicative of size quantization in as-prepared CdS nanoparticles. In our synthetic system, the investigations of CdS nanoparticles formation indicated that the nucleation and growth were well controlled. Firstly, ethylenediamine, as a strongly bidentating solvent, was ready to form relatively stable  $\text{Cd}^{2+}$  complexes [25,26]. Next, the  $\text{Na}_2\text{S}$  generate  $\text{S}^{2-}$  ions slowly and homogeneously. The  $\text{S}^{2-}$  ions will react with the  $\text{Cd}^{2+}$  ions that has chelated with ethylenediamine in a reversible and effective pathway to produce small CdS nanoparticles [27]

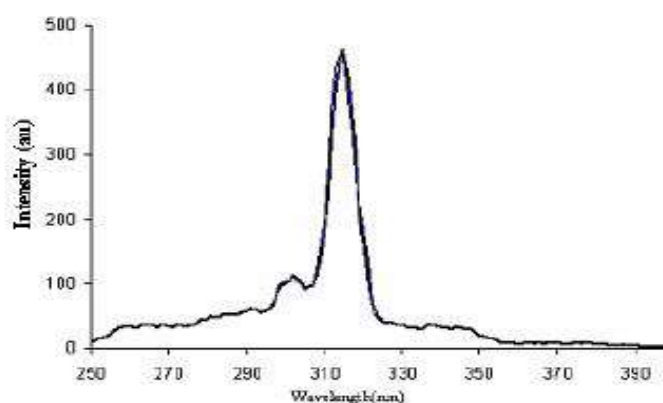

Figure 5

. Photoluminescence emission spectrum of CdS nanoparticles

## 2.3 Photovoltage measurements

**Table 2:** Open-circuit voltage ( $V_{oc}$ ) and short-circuit current ( $J_{sc}$ ) as a function of band gap for different CdS samples for photoelectrochemical solar cells.

Thickness (nm)	Band-gap	$V_{oc}$ (mV)	$J_{sc}$ ( $\mu\text{A}/\text{cm}^2$ )
40	2.95	679	458
20	3.01	686	458

Table 2. Shows the open-circuit voltage ( $V_{oc}$ ) and short-circuits current ( $J_{sc}$ ) as a function of band gap for different CdS samples for photoelectrochemical solar cells with configuration  $\text{Ti}/\text{CdS}/\text{Na}_2\text{SO}_3/\text{Pt}$ . The intensity of illumination used was  $60\text{mW}/\text{cm}^2$ . It is clear from the table that photovoltage increases for nanocrystalline sizes.

## Result & Conclusions

Nanocrystalline semiconductor materials such as CdS have attracted considerable attention due to their unique properties, which are not present in bulk materials. These nanoparticles exhibit size dependent properties (size quantization effects) such as a blue shift of absorption onset, a change of electrochemical potential of band edge, and an enhancement of photocatalytic activities, with decreasing crystallite size. CdS, in particular, have been extensively studied due to their potential applications such as field effect transistors, light emitting diodes, photocatalysis and biological sensors. Many synthetic methods have been employed to prepare CdS nanoparticles including soft chemical reaction, solid-state reaction, sonochemical preparation, microwave heating, photoetching and reverse micelle. In this investigation, we have developed a new method to produce CdS nanoparticles of small sizes using sol gel process.

The XRD pattern of CdS nanoparticles showed the materials to be of the nanometric size regime with a predominantly cubic phase. It was shown that the sizes of nanoparticles are 30-40 nm, which confirms from SEM.

The transmission electron microscopy (TEM) pattern shows that most of the particles are characterized by an angular shape with an average size of 10 nm. To determine the structure of isolated triangular nanocrystals, high-resolution transmission electron microscopy (HRTEM) experiments and image processing



by the square Fourier transform (power spectrum, PS) are performed. The HRTEM image of the triangular nanocrystals shows several lattice planes. The PS shows several well defined sharp spots:

The CdS nanoparticles showed blue shift in their UV-VIS absorption band edge. The PL spectrum of CdS nanoparticles showed fluorescence band with a maximum at about 315 nm.

Photovoltage measurement shows that the photovoltage increases for nanocrystalline sizes.

## References

- 1] T. Vossmeier, L Katsikas, M Giersig, G I Popovic, H. Weller, J. Phys. Chem. 98,7665 (1994).
- 2] V. L. Colvin, A. P. Alivisatos, J. G Tobin, Phys. Rev. Lett.66, 2786 (1991).
- 3] A. N. Goldstein, C. M Echer, A. P. Alivisatos, Science 256, 1425 (1992).
- 4] S. H Tolbert, A. P Alivisatos, Annu. Rev. Phys. Chem., 46,595 (1995).
- 5] C. B Murray, D. B Norris, M. G. Bawendi, J. Am. Chem. Soc.115, 8706 (1993).
- 6] A. P. Alivisatos, Mater. Res. Soc. Bull., 20, 23. (1995).
- 7] J. J Shiang, A.Kadavanich, R. K. Grubbs, A. P. Alivisatos, J.Phys. Chem, in press.
- 8] M. G. Bawendi, , A. R Kortan. M. L. Steigerwald, L. E. Brus. J.Chem. Phys, 91, 7282 (1989).
- 9] D. J. Wales, R. S. Berry, Berry ,Phys. Rev. Lett. 73, 2875 (1994).
- 10] A. I Ekimov, A. A. Onushchenko, Fiz. Tekh. PoluproVodn, 16, 1215 (1982).
- 11] R.Rossetti, S.Nakahara, L. E. Brus, J. Chem. Phys. 79,1086 (1983).
- 12] M. L Cohen, M. Y Chou, W. D. Knight, W. A. de Heer, J.Phys. Chem. 91,3141.C. R. C Wang, S Pollack, T. A. Dahlseid, (1987), G. M. Koretsky, M. J Kappes,Chem. Phys. 96, 7931. C.Ellert, (1992), M Schmidt, C. Schmitt, T. Reiners, H Haberland. Phys. Rev. Lett. 75, 1731 (1995).
- 13] M. A. Kastner, Rev. Mod. Phys., 64, 489 (1992).
- 14] D. C. Ralph, C. T Black, M. Tinkham, Phys. Rev. Lett. 74, 3241 (1995).
- 15] D. L. Klein, P. L. McEuen, J. E. Bowen Katari; R. Roth,Alivisatos, A. P. A
- 16] This section, important for placing nanocrystals in a context, recently appears in abbreviated form: Alivisatos, A. P. Science 271, 993 (1996).
- 17] A Liu, Q.-L Zhang,F. K.; Tittel, R. F Curl,R. E. Smalley, J.Chem. Phys.85, 7434 (1986).
- 18] U.Rothlisberger, W. Andreoni, M Parrinello, Phys. Rev. Lett., 72, 665 (1994).
- 19] C. C Arnold, D. M. Neumark, J. Chem. Phys., 99, 3353(1993).
- 20] The remarkable case of C60, discovered in molecular beam studies, but structurally characterized only after it could be produced in large quantities,demonstrates clearly the complementary roles played by gas and condensed phase studies of clusters.
- 21] L. Sapanhel, M.A. Anderson, Synthesis of porous quantum-size cadmium sulphide membranes: photoluminescence phase shift and demodulation measurements J. Amer. Chem. Soc. 112, p. 2278-2284(1990).
- 22] A Jeol JEM 100CX II (100 kV) was used for TEM. A Philips CM 200 (200 kV) without field emission gun (FEG) was used for TEM high-tilt experiments.
- 23] A Philips CM 200 (200 kV) with FEG was used for HRTEM and electron diffraction. Electron diffraction images are circularly averaged to get better homogeneity of the image and better separation of the diffractions.
- 24] Semper Version 6 was used to perform PS and image processing of electron diffraction.
- 25] Cerius Version 5 was used to perform single-crystal diffraction calculations and structure simulation.
- 26] J. H. Fendler, Chem. Rev. 87, 877 (1987).
- 27] J. Nanda, B. A. Kuruvilla, K. V. P. M. Shafi, and D. D. Sharma, Phys. Sem.Nanostruct. 25 (1997).
- 28] Y. Wang and N. Herron, J. Phys. Chem. 95, 525(1991).

## Structural, Microstructural Characterization & Electrical Transport Studies Of Nano Cds For Nano Electronic Applications

Chandrakant Balu Mane,  
Assistant Prof. in Chemistry  
Department of Chemistry  
V. Y. M. Pethvadgaon.  
Email:cbmane007@gmail.com

Vilas. Shamrao Patil,  
Assistant Prof. in Physics,  
Department of physics  
Y. C. W. M. Waranagar,  
Email: vilaspatilkodoli2201@gmail.com

### Abstract

*The work mainly concerns with study of the structural details, microstructure, and optical properties of the CdS thin films. Various properties like optical absorbance, dc and ac conduction behavior have been investigated in close correlation with the microstructure of the films. It involves the study of nanocrystalline CdS thin films by sol-gel spin coating deposition techniques, studying growth, microstructure, and morphology and from that correlating the microstructure to its physical, electrical and optical properties.*

*Keywords : morphology, microstructure.*

### 1.0 Introduction

The study of semiconductor nanoparticles has been an interesting field of research for more than two decades. This is because it gives an opportunity to understand the physical properties in low dimensions and to explore their vast potential for applications, e.g. in optoelectronics [1-4]. The latter is particularly based on the large variations of the band gap as a function of particle size, which is a consequence of quantum confinement [5-11]. Moreover, small nanoparticles allow the study of relevant surface properties due to the high surface to bulk ratio. In semiconductor nanoparticles, strong confinement effects appear when the size of the nanoparticles is comparable to the Bohr radius of the exciton in the bulk material. The confinement effect is observed for CdS particles when the particle sizes are equal to or less than 50 Å [9, 10]. Bulk CdS is widely used as a commercial photodetector in the visible spectrum. It is also used as a promising material for buffer layers in thin film solar cells [12, 13]. The optical properties of CdS nanoparticles have been extensively studied in recent years as this material exhibits pronounced quantum size effects [14, 15]. A lot of work has been done on the preparation of these nanoparticles, and a wet chemical synthesis has come up as a promising technique because of the ability to produce various sizes and large quantities of the nanoparticles [14, 16-18]. Since very small nanoparticles have larger surface to volume ratios, many properties are directly related to the particle surface. The surface properties of the nanoparticles have been studied much less than the bulk properties [19, 20], even though this information is of significant importance, and therefore many interesting aspects of nanoparticles are still not revealed. Photoelectron spectroscopy (PES) has a great potential to probe the surface of such particles. This is because of the small inelastic mean free paths of emitted photoelectrons,

### 2.0 Structure of CdS:

Cadmium sulphide is a wide band gap semiconductor with  $E_g \approx 2.5$  eV [21]. It is used in photodetectors and for solar cell applications as n-type window layers in heterojunction devices [22]. The optical properties of CdS have been extensively studied [23, 24]. Quantum size effects are quite pronounced because CdS has a rather large  $r_B$  ( $\approx 3$  nm) [25]. CdS nanoparticles are attractive candidates for optoelectronic applications as it is possible to engineer the band gap over a wide spectral range (visible to UV). Bulk CdS has a hexagonal wurtzite-type (W) crystal structure with  $a = 0.4160$  nm and  $c = 0.6756$  nm [26]. Two other structures (see table 1) are observed *only* in nanocrystalline CdS [36]: (a) a cubic zinc blende (Z) phase under ambient conditions, and (b) a high-pressure rock salt phase [27]. The wurtzite to rock salt transformation involves not only a change in symmetry (hexagonal to cubic) but also a change in the nearest-neighbour atomic coordination (from four to six), whereas the wurtzite to zinc blende transformation involves only a change in symmetry. The two types of transition are affected by particle size in different ways.

There exists a large number of methods to obtain clusters with different properties. These were developed over many years. The cluster preparation methods can be classified in two general classes as gas phase methods and condensed phase methods. Often gas phase clusters are produced and studied in the gas phase only, or they are deposited on a solid surface. These methods are used for small quantities of clusters. The second class of synthesis is that in which the clusters are obtained in the condensed phase. These methods are mainly divided into two classes as chemical and physical methods. Chemical methods are promising in terms of cost reduction and ability to produce large amounts of particles. Usually the nanoparticles are being capped by different organic molecules since this is an easy way of stabilizing them to avoid agglomeration. CdS nanoparticles are of the great interest since many years. The reason may be that this small band gap material shows interesting size quantization effects (below the Bohr radius, i.e. 30 Å), and the nanoparticles can be obtained in macroscopic amounts for various characterizations, which is difficult for many other II-VI

semiconductor particles excluding CdSe and to some extent CdTe. An important aspect of research on nanoparticles has been to prepare size selected particles in order to study various size dependent features. There were many efforts to synthesize size selected CdS with a very narrow size distribution, however only a few were successful [2, 4,5]. Most of the techniques follow an organic capping route and a wet chemical synthesis with solvents like ethanol, methanol, acetonitrile, dimethylformamide(DMF), etc. The particles are obtained as free standing powders and can be redissolved to form a “nanoparticles solution”. Polyphosphate and thiols are the most commonly used capping agents. Use of monochromatic light to irradiate a colloidal solution of CdS particles was adopted in order to produce various sizes. Gel electrophoresis in order to separate sizes was used [23]. Monodispersed CdS particles can be found in the literature in a few cases [12], A report on photoemission studies also shows nice absorption spectra of two monodispersed CdS nanoparticles (produced in DMF) [15]. We have done an extensive literature search in order to reach our goal of producing highly monodispersed nanoparticles using wet chemical synthesis

### 3.0 Materials and Methods

#### 3.1 Transmission Electron Microscope (TEM)

Fig.1.A) TEM image of CdS triangular shaped nanocrystals. B) HRTEM of a nanocrystal. C) PS of this nanocrystals. The transmission electron microscopy (TEM) pattern (Fig. 1A) shows that most of the particles are characterized by an angular shape with an average size of 10 nm. To determine the structure of isolated triangular nanocrystals, high-resolution transmission electron microscopy (HRTEM) experiments and image processing by the square Fourier transform (power spectrum, PS) are performed. A large collection of triangular nanocrystals is used and the data

obtained are highly reproducible. The HRTEM image of the triangular nanocrystals shows several lattice planes (Fig. 1 B). The PS shows several well defined sharp spots: the inner three pairs are characterized by an inter-plane distance of  $3.626\text{\AA}$ . The second order is well defined. Another series of spots corresponds to a distance of  $2.1094\text{\AA}$  with a  $60^\circ$  angle between the spots. These experimental data are compared with the calculated single crystal diffraction patterns oriented in [111] and [001] direction for cubic (zinc blende) and hexagonal (wurtzite) structures, respectively. For the cubic phase, the first order external diffraction spots are observed. Conversely, for the hexagonal phase all the spots are present (inner and external).

Table 1 compares the calculated and experimental data of the inter-planar distances and shows rather good agreement between these data. The spots corresponding to 100, 110, and 200 diffraction of the hexagonal structure (wurtzite) are shown in Fig. 11C. Hence, from this, it can be concluded that isolated triangular nanocrystals are crystallized in a wurtzite structure. The well-defined second-order diffraction spots indicate a high crystallinity of the nanoparticles. The triangular shape of PS spots (Fourier transform form factor) indicates a highly homogeneous surface. Thus, at the few-nanometer scale it can be concluded that the isolated triangular particles are highly crystallized in a hexagonal structure with a homogeneous surface. Figure 2 also shows nanocrystals having other shapes. It is difficult to know if they result from coalescence after growth or they grow like that. However, from the results obtained with other nanocrystals the tendency will be to say that they grow like that.

**Table 1.** Calculated single crystal diffraction for the [001] plane of wurtzite CdS with electron radiation  $k = 0.02508\text{\AA}^{-1}$  compared with the experimental results

Diffraction	d calculated ( $\text{\AA}$ )	d experimental ( $\text{\AA}$ )
100	3.5861	3.626
110	2.0705	1.810
200	1.7931	1.810

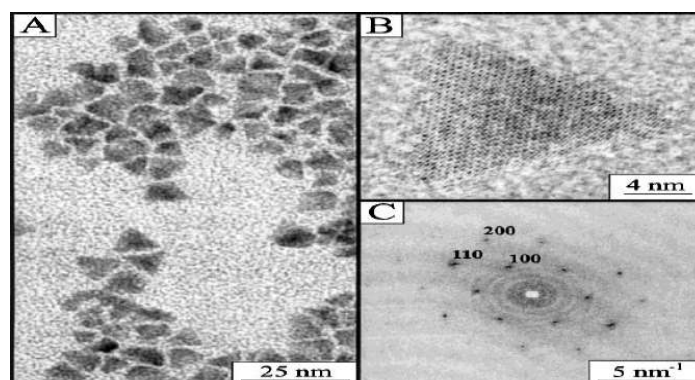

**Figure 1.** A) TEM image of CdS triangular shaped nanocrystals. B) HRTEM of a nanocrystal. C) PS of this nanocrystal

## Scanning Electron Microscope (SEM)

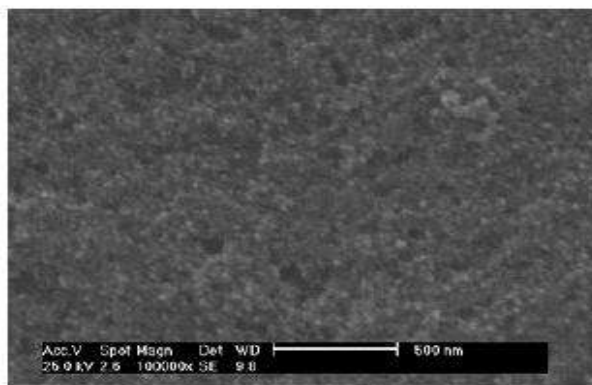

**Figure 2.** SEM image of CdS nanoparticles

### 4.0 Electrical transport studies

#### 4.1 Electrical Conductivity

Variation of dc conductivity  $\sigma_{dc}$  and ac conductivity  $\sigma_{ac}$  of CdS with temperature is shown in figure 3. The  $\log \sigma_{dc}$  vs  $1000/T$  graph of CdS shows two distinct regions, the first region indicating a slow increase of conductivity with temperature and the second one indicating a rapid increase beyond this temperature.  $\sigma_{ac}$  of CdS samples is found to increase linearly with frequency. Ac conductivity  $\sigma_{ac}$  increases at a low rate with temperature initially and more rapidly beyond about 425K. The  $\sigma_{ac}$  versus  $1000/T$  graphs of the samples at low frequencies show a maximum around almost the same temperature. The variation of dielectric constant  $\epsilon$  and the ac conductivity  $\sigma_{ac}$  of the CdS samples as function of temperature is shown in figure 4.

It is clear from the present study that the dc conductivity of CdS increases at a lower rate or is approximately constant up to 500K and thereafter the conductivity increases at a rapid rate. Beyond  $T_c$  it is seen that the portion of the  $\sigma_{dc}$  versus  $1000/T$  is almost a straight line showing an Arrhenius behaviour. The lack of dependence of conductivity on temperature up to  $T_c$  may be attributed to the large band gap (nanosize), due to which the charges are not released from the particles by thermionic emission are not available for tunneling. The conductivity above  $T_c$  is due to both thermionic emission and tunneling of charge carriers across the barrier. Because of the small size of the particles, the charge carriers reach the surface of the particles more easily enabling easy electron transfer by thermionic emission, or tunneling or both, enhancing the conductivity

The dielectric constant of nanoparticles of CdS is found to be larger than the corresponding values of CdS crystals [30, 31]. Also  $\sigma_{ac}$  of CdS is much larger than that of the bulk crystals [32, 33]. Unlike the case of ionic crystals, where the effective fields CdS nanocrystalline were synthesized using thiophenol as capping agent. By changing the relative ratio of sulphide to thiophenol, clusters of different sizes were obtained. Electrical and optical properties of CdS nanocrystallites exhibit extraordinary behavior over that of bulk.

$$E_{eff} = E + (4/3) \pi P,$$

For semiconductors  $E_{eff}$  should be essentially equal to the macroscopic field  $E$ ,

$$\text{i.e. } E_{eff} = E.$$

This leads to an expression for  $\epsilon$  of the form  $\epsilon - 1 = 4\pi\alpha/V$  where  $V$  is the volume. The large value of  $\epsilon$  of pallets of nanoparticles of CdS compared to the corresponding bulk values may due to the small of  $V$  in the above expression. The very large value of  $\sigma_{ac}$  of CdS may be attributed to the defect structure of the particles [34, 35].

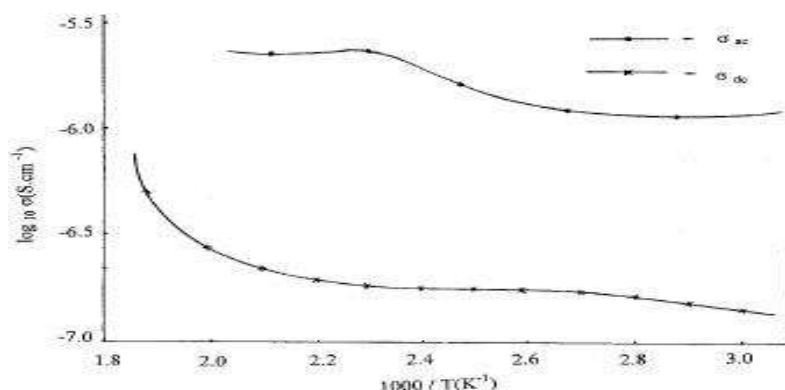

**Figure 3.** Variation of log of dc conductivity  $\sigma_{dc}$  and ac conductivity  $\sigma_{ac}$  of CdS with  $1000/T$ .

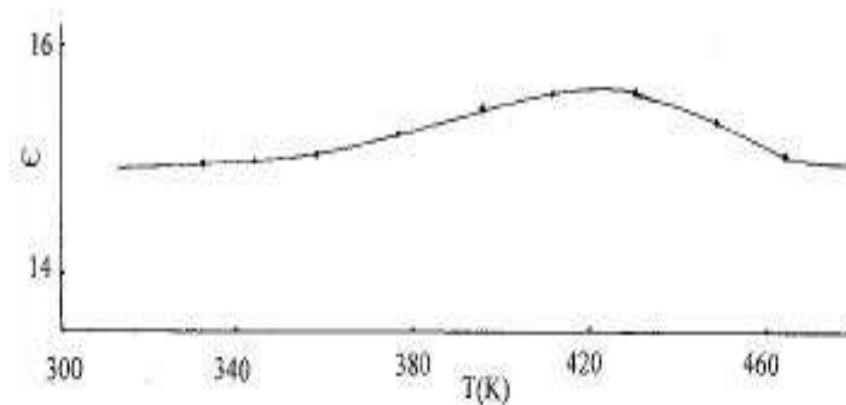

**Figure 4.** Variation of dielectric constant  $\epsilon$  of CdS samples with temperature

## 5.0 Result & conclusion

The basic principle of sol-gel technique is to make a solution of the elements of desired composition in an organic solvent, polymerize the solution to form gel then it is decomposed in the substrate in a spin coater with in definite speed of rotation to form a uniform thin films.

The XRD pattern of CdS nanoparticles showed the materials to be of the nanometric size regime with a predominantly cubic phase. It was shown that the sizes of nanoparticles are 30-40 nm, which confirms from SEM.

AFM analysis of a film shows that the surface is composed of crystallites with an approximate size of 30 nm grouped together into larger agglomerates.

The transmission electron microscopy (TEM) pattern shows that most of the particles are characterized by an angular shape with an average size of 10 nm. To determine the structure of isolated triangular nanocrystals, high-resolution transmission electron microscopy (HRTEM) experiments and image processing by the square Fourier transform (power spectrum, PS) are performed. The HRTEM image of the triangular nanocrystals shows several lattice planes. The PS shows several well defined sharp spots:

The  $\log \sigma_{ac}$  vs  $1000/T$  graph of CdS shows two distinct regions, the first region indicating a slow increase of conductivity with temperature and the second one indicating a rapid increase beyond this temperature.  $\sigma_{ac}$  of CdS samples is found to increase linearly with frequency. Ac conductivity  $\sigma_{ac}$  increases at a low rate with temperature initially and more rapidly beyond about 425K. The  $\sigma_{ac}$  versus  $1000/T$  graphs of the samples at low frequencies show a maximum around almost the same temperature.

## 6.0 References

- [1] H. M. Gibbs and G. Khitrova, Semiconductor nanocrystals for non-linear optical devices, in non-linear photoionics, edited by H. Gibbs, G. Khitrova, and N. Peyghambarian, Springer, Berlin, Heidelberg (1990).
- [2] S. V. Gaponenko, "Optical Properties of Semiconductor Nanocrystals", Cambridge Univ. Press (1998).
- [3] I. Ekimov and A. L. Efros, Phys. Sta. Sol. B 150, 627 (1988).
- [4] L. E. Brus, Appl. Phys. A 53, 465 (1991).
- [5] A. I. Efros and A. L. Efros, Sov. Phys. Semicond. 16, 772 (1982).
- [6] L. E. Brus, J. Chem. Phys. 79, 5566 (1983).
- [7] L. E. Brus, J. Chem. Phys. 80, 4403 (1984).
- [8] Y. Kayanuma, Solid State Commun. 59, 405 (1986).
- [9] Y. Wang and N. Herron, Phys. Rev. B 42, 7253 (1990).
- [10] P. E. Lippens and M. Lannoo, Phys. Rev. B 39, 10935 (1989).
- [11] A. P. Alivisatos, Science, 271, 933 (1996).
- [12] W. I. Danaher, L. E. Lyons, and G. C. Morris, Sol. Energy Mater. 12, 137 (1985).
- [13] L. Weinhardt, Th. Gleim, O. Fuchs, C. Heske, E. Umbach, M. Bär, H.-J. Muffler, Ch.-H. Fischer, M.C. Lux-Steiner, Y. Zubavichus, T.P. Niesen, and F. Karg, Appl. Phys. Lett. 82, 571 (2003).
- [14] R. Rossetti, J. L. Ellison, J. M. Gibson, and L. E. Brus, J. Chem. Phys. 80, 4464 (1984).
- [15] N. Herron, J. C. Calabrese, W. E. Farneth, and Y. Wang, Science 259, 1426 (1993).
- [16] T. Vossmeier, L. Katsikas, M. Giersig, I. G. Popovic, K. Diesner, A. Chemseddine, A. Eychmüller, and H. Weller, J. Phys. Chem. 98, 7665 (1994).
- [17] H. Weller, U. Koch, M. Gutierrez, and A. Heglein, Ber. Bunsenges. Phys. Chem. 88, 649 (1984).
- [18] A. Fojtik, H. Weller, U. Koch, A. Heglein, Ber. Bunsenges. Phys. Chem. 88, 969 (1984).

- [19] J. R. Sachleben, E. W. Wooten, L. Emsley, A. Pines, V. L. Colvin, and A.P. Alivisatos, Chem. Phys. Lett. 198, 431 (1992).
- [20] J. Rockenberger, L. Tröger, A. Rogach, M. Tischer, M. Grundmann, A. Eychmüller, and H. Weller, J. Chem. Phys. 108, 7807 (1998).
- [21] F. Y. Chen and R. L. Johnston, Appl. Phys. Lett. 90, 153123 (2007).
- [22] N. Sankara, C. Sanjeevirajab, and K. Ramachandran, J. Cryst. Growth 243, 117 (2002).
- [23] A. Szczerbakow, J. Bak-Misiuk, E. Dynowska, M. Ghali, M. Godlewski, V. Yu. Ivanov, and K. Szwiatek, J. Cryst. Growth 216, 532 (2000).
- [24] S. M. Zhou, Y. S. Feng, and L. D. Zhang, J. Cryst. Growth 252, 1 (2003).
- [25] L. Qi, J. Ma, H. Cheng, and Z. Zhao, Colloids Surf. 111, 195 (1996).
- [26] L. A. Patil, P. A. Wani, K. B. Saraf, and M. S. Wagh, Cryst. Res. Technol. 33, 233 (1998).
- [27] U. Hotje, C. Rose, and M. Binnewies, Solid State Sci. 5, 1259 (2003).
- [28] H. Gleiter, Nanostruct. Mat. 1, 1 (1992).
- [29] M. G. Bawendi, P. J. Corroll, W. L. Willson, and L. E. Brus, J. Chem. Phys. 96, 946 (1992).
- [30] J. Nanda, B. A. Kuruvilla, K. V. P. M. Shafi, and D. D. Sharma, Phys. Sem. Nanostruct. 25 (1997).
- [31] K. K. Nanda, S. N. Sarangi, and S. N. Sahu, Phys. Sem. Nanostruct. 217 (1997).
- [32] C. Elbaum, Phys. Rev. Lett. 32, 376 (1974).
- [33] P. Merchant and C. Elbaum, Solid State Commun. 26, 73 (1978).
- [34] K. Shahi and K. Wagner, J. Electrochem. Soc. 128, 6 (1981).
- [35] K. Shahi and J. B. Wagner, J. Electrochem. Soc. 42, 107 (1982).



## Nanocrystal Devices (Light Emitting Devices and Plasmonics) For Electric Energy Conservation Applications

**Vilas. Shamrao Patil,**  
Assistant Prof. in Physics,  
Department of physics  
Y. C. W. M. Waranagar,  
Email: vilaspatilkodoli2201@gmail.com

**Avinash Ladgonkar.**  
Assistant Prof. in Physics,  
Department of physics  
Y. C. W. M. Waranagar,  
Email: ladgoankar.avinash1@gmail.com

### Abstract:

*Solid-state lighting (SSL) is an - illumination technology that has emerged in the past decade due to the development of white light-emitting diodes (LEDs). Currently, LEDs use a mature technology that can outperform traditional light sources due to their higher efficiencies, longer lifetimes, fast switching, robustness and compact size. The working principle of LEDs is based on electroluminescence, that is, the radiative recombination of injected electron-hole pairs in a material. We expect to see widespread replacement of traditional light sources, with LEDs within the next two decades, leading to considerable reduction in worldwide electricity consumption. To facilitate this transition, we must integrate LEDs into many different applications. To do this, we must be able to accurately and specifically control brightness, color and directionality of light emitted from LEDs. It appears that this control may be achieved using nanostructures. Metallic nanostructures supporting plasmonic resonances are an interesting alternative to this approach due to their strong light-matter interaction, which facilitates control over light emission without requiring external secondary optical components.*

### Keywords:

#### 1. Nanocrystal Devices

Examples of NC devices include photoresistors, diodes with rectifying I-V characteristic, field-effect transistors, memory elements, light-emitting and photovoltaic devices, etc. All of these have been recently assembled from chemically synthesized metal and semiconductor NCs. Among the benefits provided by this class of electronic materials, there are properties inherent to nanoscale materials such as size-dependent electronic structure, charging energy, melting temperature, and other parameters that can be finetuned by varying NC size. For example, superior luminescent properties of semiconductor NCs (size-tunable color, narrow emission band, almost 100% luminescence quantum efficiency, high stability, etc.) have been utilized in light-emitting devices (LEDs). In addition, colloidal NCs offer opportunities for inexpensive device fabrication by solution-based techniques like spin-coating, dip-coating, inkjet printing, etc., and can be used in roll-to-roll processing. As a result, colloidal NCs are considered as a very promising class of materials for large area applications, such as thin film solar cells and for the applications where low fabrication cost is very important. Along these lines, solution-cast NC field-effect transistors (FETs) show respectable carrier mobilities, which compare favorably to the best devices made from organic electronic materials. (23,24,87,130,132) Several interesting concepts have been proposed for NC-based solar cells. (115, 133-136) The progress in developments of commercially successful NC devices requires collaborative efforts of chemists synthesizing new materials, scientists studying materials properties, engineers working on device architecture, and technologists involved in the process of device fabrication. In this section, we provide an overview of state-of-the-art for several classes of applications utilizing colloidal NCs.

#### 2.. Light-Emitting Devices (LEDs)

Colloidal NCs have been explored as the emitters for thin film light-emitting diodes (LEDs). (137-145) In a typical LED, a thin layer of light-emitting NCs, for example, CdS/CdSe/ ZnS core-shells or Cd<sub>1-x</sub>Zn<sub>x</sub>Se (recombination layer), is sandwiched between the hole transport layer (HTL) and electron transport layer (ETL), which provide injection of carriers into the NCs (**Figure.1**.) The performance of NCs-based LEDs has remarkably improved over the past decade. (142,146,147) Among the strong points of NC-based LEDs are their high color purity (i.e., narrow emission band) and tunability of the emission color from UV to near-IR by simply varying the NC size. (148) Because size-dependent emission of semiconductor NCs is well described by the quantum dot (QD) formalism, the NC-based LEDs are often named "QDLEDs".

To be fully competitive with other emerging

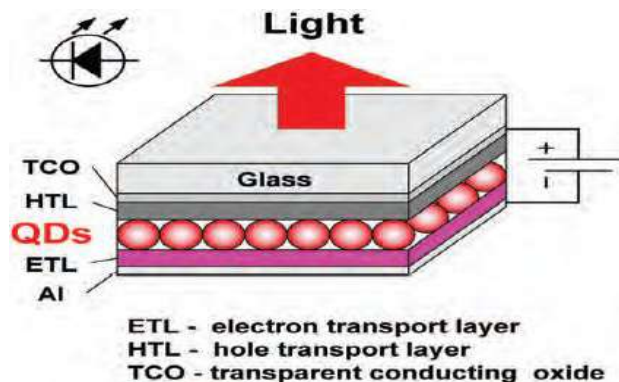

**Figure 1** Schematic diagram and a typical structure of a thin film LED utilizing semiconductor NCs technologies such as organic LEDs, both brightness and especially lifetime of QD-LEDs have to be considerably improved.

### 3.operation and review recent progress in NC-based LEDs.

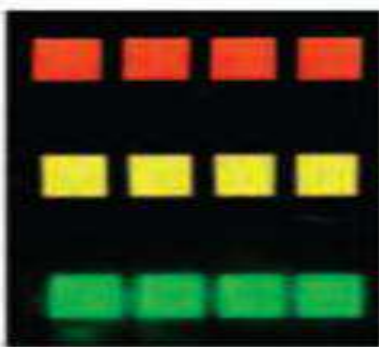
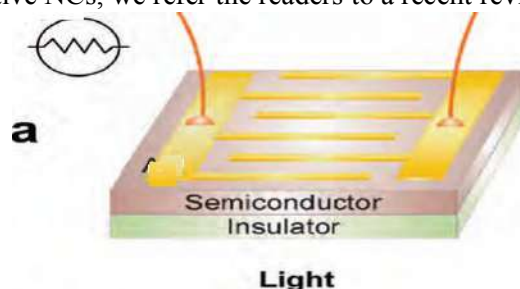

**Figure.2.**Optical photographs of green, yellow, and red light emitting devices using CdS/CdSe/ZnS core-shell nanocrystals with different sizes of CdSe cores.

### 4.Photodetectors

There is a large variety of sensitive photon detection systems operating in the visible spectral range: photomultiplier tubes, single crystal silicon detectors, and CCD cameras. Unfortunately, in the infrared the situation is not nearly as good; available detection systems, especially arraybased, are either insensitive or very expensive. The reason is simple; silicon, which is a main workhorse for CCD and APD technologies, cannot operate beyond 1.1  $\mu\text{m}$ , whereas other materials show higher noise levels or are difficult to process using standard single-crystal-based microfabrication techniques. At the same time, markets for near-IR and mid- IR detectors span from telecommunication to night-vision systems, bioimaging, environmental sensing, spectroscopy, and chemical analysis. For all of those areas, it is highly desirable to find new materials that enable high detectivity at a reasonable cost. Recent developments provide good expectations for photodetectors based on NC solids. Application of NCs for photon detection is receiving steadily growing attention. The progress in this direction is driven by the unique opportunities given by the size-tunable NC electronic structure, NC surface chemistry, and surface trap engineering, compositional flexibility, and the possibility to manufacture devices using inexpensive solution processing. Relatively wide band gaps of

conductive organic polymers and small molecules limit their absorption to visible spectral range. For applications requiring light absorption/ emission in the near-IR region, inorganic NCs, especially those made of narrow-gap PbS, PbSe, CdS/CdSe, PbTe, HgTe, InAs, and InSb semiconductors, are in strong position to compete with other technologies, because their band gap can be precisely tuned from the visible spectral region upto the wavelengths of 3500 nm. For more detail on the synthesis and optical properties of IR-active NCs, we refer the readers to a recent review by Rogach .





**Figure 3 (a)** A sketch of typical thin film photoconductive photodetector. Interdigitate electrode structure is deposited onto the surface of active semiconductor

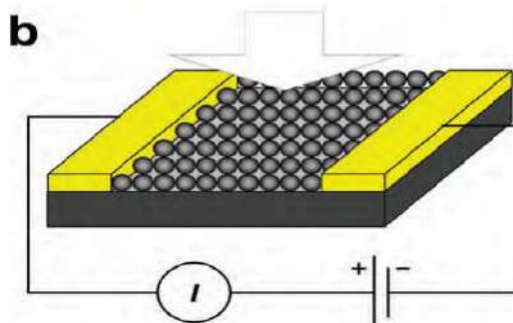

**Figure 3 (b)** A photodetector geometry that is typically used for NC-based devices: thin NC layer is deposited on top of the prepatterned electrode structure.

### 5. Light-emitting diodes (LEDs):



Fig :4 Different Light-emitting diodes (LEDs)

Light-emitting diodes (LEDs) are driving a shift towards energy-efficient illumination. Nonetheless, modifying the emission intensities, colors and directionalities of LEDs in specific ways remains a challenge often tackled by incorporating secondary optical components. Metallic nanostructures supporting plasmonic resonances are an interesting alternative to this approach due to their strong light-matter interaction, which facilitates control over light emission without requiring external secondary optical components. An efficient light source is characterized by the three following aspects:

- the generation of photons from electrical power with minimal losses
- a maximum of the generated photons illuminates the desired object, which can be for example a secondary optical element, or an open space
- the emission spectrum is optimized for the sensitivity of the detector, which in case of general lighting is the human eye. A lot of progress has been made to improve the electrical LED efficiency mentioned above in a) since the first LED has been introduced. Furthermore, over the past few years, a lot of attention has also been paid to point c), the optimization of the white light emission spectrum with respect to the human eye sensitivity curve. However, the latter has to be done with the boundary condition of still representing all the colors visible to the human eye, which is typically characterized by the color rendering index (CRI). Several ways on how to achieve highly efficient systems while maintaining an acceptable CRI have been proposed and realized.

### 6. Plasmonic LED :

Nanostructures, which have dimensions comparable to the wavelength of light, are especially, suited to enhancing light-matter modification interactions.

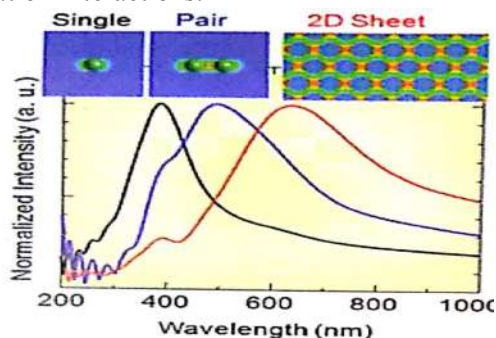

Fig. 5. graphical representation

Metallic surfaces and nanostructures supporting surface plasmon polariton (SPP) resonances are of particular interest in this regard. These resonances have their origin in the coherent oscillation of charge carriers in the metal. The spontaneous emission from sources in the proximity of metals can be modified by SPPs, thereby, influencing the emission rate and directionality. These modifications are analogous to the resonant amplification and directional radiation of antennas. Therefore, metallic nano-particles supporting SPPs have been referred to as optical antennas or nano-antennas. However, integrating such resonant nanostructures into state-of-the-art lighting applications remains challenging. The vast majority of studies has focused on modification of the emission properties of single and low-efficiency emitters, while real applications in SSL require modification of emission over macroscopic areas, typically, in the mm<sup>2</sup> range, of highly efficient emitters for which the typical photoluminescence quantum yield (QY) exceeds 90%. Until recently, these stringent requirements have limited the use of plasmonic structures for SSL. This situation is quickly changing due to the introduction of cost-effective nanofabrication techniques for use in light extraction, spectral shaping of emissions and strong beaming, without requiring additional external optical components.

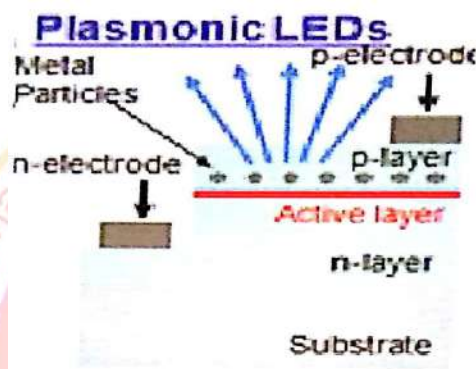

Fig. 6. Plasmonic LEDs

Plasmonic nanostructures are known to influence the emission of near-by emitters. They can enhance the absorption and modify the external quantum efficiency of the coupled system. It has been shown that periodic plasmonic metal nanoparticle (NP) arrays can largely enhance the photoluminescence of nearby emitters in particular directions for a certain narrow wavelength range. This enhancement corresponds, on the one hand, to a modification of the angular emission profile, as more light is emitted in a specific direction than in others at a particular wavelength. On the other hand, it also corresponds to a modification of the spectrum in a particular direction or small solid angle, as in this angular range more emission occurs at certain wavelengths than at others. Therefore, using periodic plasmonic arrays in combination with LED phosphors can address both points b) and c) mentioned above simultaneously. Using such a plasmonic LED device could therefore, show the following advantages over a regular phosphor-converted LED:

- Modification of the angular emission profile such that the periodic plasmonic NP array could replace (partly) bulky secondary optical structures for focusing and collimating light in lighting applications.
- Shaping of the emission to better fit the eye sensitivity, especially in the red part of the visible spectrum.

### 7. Developmental Status:

**A.** Confinement-which occurs due to the large difference in refractive index between the semiconductor and the ambient media-leads to severe total internal reflection at the interface, lowering the light extraction efficiency (LEE) of III nitride LEDs. The light trapped inside of the LED device is eventually reabsorbed, thereby, decreasing its efficiency. To achieve high light excitation and output performance, LEE enhancement is crucial. By modifying the chip shape or its surface morphology, the LEE can be improved. Several approaches have been proposed for the fabrication of different structures, either-inside of the substrate or on its surface (e.g., photonic crystals, nano pyramids, a patterned substrate, surface roughness, and reflectors). The typical scale of these structures ranges from a few hundred nanometers to a few micrometers, depending on the resolution limit of the optical lithographic technology used.

**B.** New methods that enhance the efficiencies of LEDs using nanostructured metals are being investigated, this is an emerging field that incorporates physics, materials science, device technology and industry. To evaluate the possibility of using plasmonics to enhance the light emission of a phosphor converted LED device and create an efficient directional light sources, regular arrays of aluminum nanoparticles covered with a red dye layer are under investigation. In array; of aluminum nanocylinders, with a diameter of 140nm combined with a thin (650 nm) layer of luminescent material, very narrow resonances

have been observed, which leads to large enhance factors of up to 70 and 20 for excitation with the directional blue laser sources and a lambertian LEDs respectively, in a small spectral range in particular angles. These changes in angular emission profile of the red dye as well as the spectral shape of its emission can help to optimize the efficacy of phosphor-converted LED modules and increase the amount of useable light in a certain angular cone. Using Foul ier microscopy, large modifications of the angular emission profile as well as spectral shaping ;ire observed for these plasmonic LED device if compared to reference plasmonic samples without nanostructures.

Inorganic blue LEDs that are based on InGaN/GaN multi-quantum-well heterostructures are currently used in advanced architectures to obtain white-light emission. However, light generated in the active region of the multi-quantum-well structure can be reflected at the interfaces and trapped in the layered structure before it reaches the phosphor. To remedy this and maximize light extraction, metallic surfaces and nanostructures have been used. The metallic thin films used with SPPs have been applied directly to LEDs to enhance the spontaneous emission rate of excitons in quantum wells. The process can be explained as follows. Electron-hole pairs are injected in the active region of the LED. When a metal layer is grown at a distance smaller than the evanescent decay length of the SPPs, the electron-hole pairs recombine, giving their energy to the SPPs. Thus, the metal provides additional states for exciton recombination. This enhanced density of states for exciton recombination can significantly increase the recombination rate. Because SPPs are evanescent surface waves, they cannot radiate to free space. The metallic surface can be made rough to efficiently couple SPPs to free space radiation and enhance the emission intensity. Enhancement of the visible light emission originates from a combined higher recombination rate and a higher quantum-well extraction efficiency enabled by the nanometer-sized roughness in the metal layer. Although such random textures result in improved extraction efficiencies, they provide little control over the directionality of the emitted light, which typically displays a Lambertian profile.

C.Accurate control over the angular distribution of the emission can be achieved using metallic nanostructures, which are directly fabricated, with predetermined geometries and dimensions, on the emissive semiconductor surface. A periodic designs may also be used to avoid undesirable angular and/or spectral dependencies. Unidirectional beaming of the LED emission has been recently demonstrated using a periodic array of optical antennas with specifically designed geometries. The silver flat film causes a substantial reduction in the intensity of the emitted light for both polarizations because no mechanism is provided to scatter the excited SPPs into radiation. In contrast, in the direction of the maximum intensity for one polarization, the output intensity of the LED with metallic nanostructures is enhanced compared with that of the flat sample. This polarization dependence can be attributed to the asymmetric shape of the nanostructures. Emission enhancements with a preferential light polarization can be beneficial for applications where light impinges upon smooth surfaces at nearly grazing angles, for example, automotive lighting. In these cases, it may be desirable to selectively enhance the emission obtained for one polarization only, because the other polarization may lead to unwanted effects, such as glare from incoming drivers.

D.At the LSPR wavelength (-650 nm), the nanopyramid array beams more light toward the bottom of the pyramids. The opposite occurs at the SLR wavelength (-585 nm). These effects are due to the enhanced magnetoelectric response of the nanopyramid array (magnetic dipole moments are excited via the electric field of light), which originates from the pyramidal shape and height of the nanostructures. Future research should further investigate these phenomena in order to increase emission asymmetry maximize the fraction of the emitted intensity that can be efficiently used in SSL.

**Limitless Advantages :-** LEDs constitute a new technology that is currently driving substantial changes in the way artificial light is generated .Several applications, for example, screen or automotive lightning, require light to be directed in only one direction. For planar structures, such as shallow nano-antenna arrays, light beaming into small angles is enhanced with roughly equal strength in the forward and backward directions. The light emitted backward must be recycled using secondary optics, resulting in losses. To address this issue, forward-backward light emission symmetry of planar structures can be broken by integrating an array of nanostructures with a pyramidal shape into the fluorescent layer. The inclusion of metallic . nanoparticles minimizes the need for optical components in LEDs, such as parabolic mirrors or condenser lenses that are used for beaming the emission. These optical elements are often bulky, increasinc; the total size of the LEDs and limiting their integration. Therefore, the performance of metallic nanoparticle arrays in SSL applications must be assessed in terms of overall system efficiency with and without the presence of the metallic nanoparticle arrays. From a device perspective, the enhancement of phosphor-layer emissions enabled by the use of nanoparticles must not only be compared with emissions obtained from the same layer when no nanoparticles are used. We must also compare the results obtained with the same phosphor layer under conditions in which the usual secondary optical elements are in place. An additional

advantage of nanoantenna-enhanced emission is that it also reduces the phosphor layer thickness, which is important with regard to heat dissipation. Heat reduces emission efficiency, limiting the performance of LEDs. So far, it has not been easy to use thin layers in pc LEDs owing to their low blue absorption; the Conversion efficiencies of these layers have not been sufficient to generate the desired emission spectrum.

**Results and Problems:** The texturing process still has several disadvantages, h (Meyer, including non-uniformity, high cost, material citogirtsdhaition, and limited efficiency enhancement. Due trans gh °Ptical transparency and low resistivity, a Parent conductive oxide layer (TCL) can be employed on the LED surface as an effective current spreading layer and graded refractive index material. Although the physics of strongly coupled Plasmon emitter system very rich, and the prospect of strongly interacting emitters is exciting, the potential of this for use in light-emitting devices has rarely been discussed. One of the challenges in this only one regard is related to the poor QY that phosphor layers with high densities of organic molecules display. Although it is required to access the strong coupling regime, a high molecular density degrades the photoluminescence quantum yield QY of the ensemble via an effect known as 'concentration quenching'. Therefore, challenges remain with regard to improving high-QY light-emitting devices via strong emitter-plasmon coupling .

### References:

- (1) Link, S.; El-Sayed, M. A. J. Phys. Chem. B 1999, 8410.
- (2) Efros, A. L. SoV. Phys. Semicond. 1982, 16, 772.
- (3) Brus, L. J. Phys. Chem. 1986, 90, 2555.
- (4) Murray, C. B.; Sun, S. H.; Doyle, H.; Betley, T. MRS Bull. 2001,26, 985.
- (5) International Technology Roadmap for Semiconductors, 2005; available online at <http://public.itrs.net/>.
- (6) Thin Film Transistors; Kagan, C. R., Andry, P., Eds.; Marcel Dekker:New York, 2003.
- (7) Friend, R. H.; et al. Nature 1999, 397, 121.
- (8) Avouris, P.; Chen, Z.; Perebeinos, V. Nat. Nanotechnol. 2007, 2,605.
- (9) Duan, X.; Niu, C.; Sahi, V.; Chen, J.; Parce, J. W.; Empedocles, S.; Goldman, J. L. Nature 2003, 425, 274.
- (10) Mitzi, D. B.; Chondroudis, K.; Kagan, C. R. IBM J. Res. DeV. 2001,45, 29.



## Voltage Measurement Using Digital voltmeter for different electrical appliances: Power Saving by VHDL Language.

Ms. Rohini Patil<sup>1</sup>, Mr. Patil Vilas Shamrao.<sup>1</sup>

<sup>1</sup>Assistant Professor,

Department of Physics, Y.C.W.M. Warananagar.

### Abstract:

In India now day there are crisis in power like petroleum, natural gases, electric energy. In India generate an electric power is to save electric power is need of hour. For this calibrated/ accurate measurement of electric energy is essential for which digital voltmeter are used, which measure electric energy digitally. As electric power is pollution free form of energy and it is highly used for giving luxuries' services to human being. The digital voltmeter are IC based hence it has high degree of accuracy in measurement. Digital voltmeter can display numerical value of voltage on a display by using ADC. Here "IN0 to IN7" of ADC is configured to acquire an analog data available at its inputs. ADC converts it into digital & sends out that data to VHDL kit. The VHDL kit reads the outputs of ADC, using vhdl program it convert binary number into decimal, displays analog voltage on the screen at the same time. It is calibrated voltage measurement can be used for proper billing and power saving purpose in developing country like India. This paper focus the light on how to fabricate high accuracy calibrated IC based digital voltmeter for electricity saving purpose in India.

### 2. Introduction-

Digital voltmeter can display numerical value of voltage on a display by using analogue to digital converter. Here "IN0 to IN7" of ADC is configured to acquire an analog data available at its inputs. ADC converts it into digital & sends out that data to VHDL kit. The VHDL kit reads the outputs of ADC, using vhdl program it convert binary number into decimal, displays analog voltage on the screen at the same time.

### 3. System Hardware-

General Description- ADC 0808, ADC 0807, ADC 0806 8-bit A/D converters. The ADC 8008 series is an 8-bit Monolithic digital to analog converter (ADC) featuring a full scale output current setting time of 150ms. While dissipating only 33 mV. With  $\pm 5V$  supplies. No reference current (I<sub>ref</sub>) Trimming is required for most applications since the full-scale output current is typically  $\pm 1$  LSB of 255 I<sub>ref</sub>/256. Relative accuracies of better than  $\pm 0.19\%$  assure 8 bit monotonically and Linearity while zero level output current of less than 4uA provides 8-bit zero accuracy for I<sub>ref</sub> 2mA. the power supply currents of the ADC 0808 series are independent of bit codes, and exhibits essentially constant device characteristics over the entire supply voltage range. The ADC 0808 will interface directly with popular TTL, DTL, or CMOS logic levels, and is a direct replacement for the MC1508/MC1408 for higher speed applications

### 4. Features-

- 1) Easy interface to all microprocessors.
- 2) Operates ratio metrically or with 5 VDC or analog span.
- 3) Adjusted voltage reference.
- 4) No zero or full-scale adjust required.
- 5) 8-channel multiplexer with address logic.
- 6) 0V to 5V input range with single 5V power supply.
- 7) Outputs meet TTL voltage level specifications.
- 8) Standard hermetic or molded 28-pin DIP package.
- 9) 28-pin molded chip carrier package.
- 10) ADC0808 equivalent to MM74C949. 11) ADC0809 equivalent to MM74C949-1.

### 5. Key Specifications-

- 1) Resolution 8 Bits.
- 2) Total Unadjusted Error  $\pm 1/2$  LSB and  $\pm 1$  LSB.
- 3) Single Supply 5 VDC.
- 4) Low Power 15 Mw.
- 5) Conversion Time 100 s.

## 6. Information Of Vhdl Programming Language

**6.1.Introduction To Vhdl :** The VHSIC Hardware Description Language is industry standard language used to describe hardware from the abstract to the concrete level. VHDL resulted from work done in the '70s and '80s by the U. S. Department of Defense. VHDL usage has risen rapidly since its inception and it used by literally tens of thousands of engineers around the globe to create sophisticated electronic products. In 1986 VHDL was proposed as an IEEE standard. It went through a number of revisions and changes until it was adopted as the IEEE 1076 standard in December 1987.

### A. Vhdl Terms:

- 1) **Entity** – All designs are expressed in terms of entities. An entity is most basic building block in design. If the design is hierarchical, then top level description will have low level description contained in it.
- 2) **Architecture**- All entities that can be stimulated have an architecture description. The architecture describes the behavior of entity. A single entity can have multiple architecture.
- 3) **Configuration**-A configuration statement is used to bind a component instance to an entity architecture pair.
- 4) **Package**- A package is a collection of commonly used data types and sub-programs used in a design. Think of a package as a tool box that contains tools used to build designs.
- 5) **Bus**- The term bus usually brings to mind a group of signals or a particular method of communication used in a design of hardware.
- 6) **Process**- Process is the basic unit of execution in VHDL. All operations that are performed in simulation of a VHDL description are broken into single or multiple processes.

## 7.0 Experimental Setup-

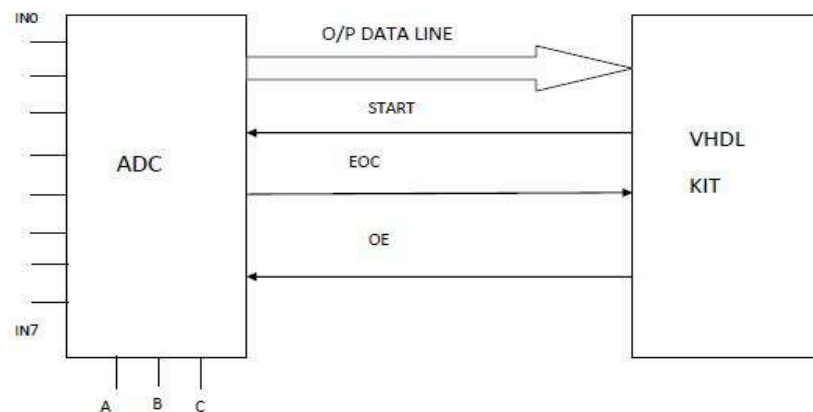

### 7.1. Setup Description:

Digital voltmeter can display numerical value of voltage on a display by using ADC. Here “IN0” of ADC is configured to acquire an analog data available at its input , ADC converts it into digital & sends out that data to VHDL kit. The VHDL kit reads the outputs of ADC, using vhdL program it convert binary number into decimal, displays analog voltage on the screen at the same time.

## 8.0 System Photograph-



**9.01 Applications: Home application Automation:** enables to have automatic, electronic, and even remote control of the home as well as the devices, fixtures, accessories, and appliances inside. Several manufacturers have already developed smart products for homes and various control systems that enable their automation.

**9.02. Use of Smart voltage measurement sysyem is summarized as:**

Light source, communication technology and applications is summarized as follows

Light Source	Power use	Data use	Applications
- Light Emitting Diode - Fluorescent Lamps - High-Intensity ----	-Wired -Digital addressable lightning interface -Power line communication	- Wireless - Zigbee -Enocan - Li-Fi - Wi-Fi	- Indoor lightning --Commercial - Industrial - Residential -Others - Outdoor Lighting - Lighting for Public Places

**9.03. Moving Head appliance:**

A moving head has the ability to change colours and patterns. It has a wide range of mobility options, such as circular, pan and tilt. The newer moving heads can rotate between 360-180 degrees. They are visually more interesting to guests and offer a larger range of movement and lighting output than scanners.

**9.04 Scanning devices :**

There are many debates whether scanners are better than moving heads or vice versa. Scanners are faster than moving head fixtures. However, moving heads will capture the interest of your guests with its moving function. In today's market, intelligent lighting is manufactured with LED technology.

**9.05 LEDs Applications:**

With Solid-State Lighting successfully established for indoor outdoor and roadway lighting, the industry is poised to take LED to new dimensions. Within the smart lighting market, light emitting diodes (LEDs) are expected to remain the largest market and are expected to witness the highest growth over the forecast period. Declining cost of LEDs, low maintenance, and high energy efficiency are expected to spur the growth of this This really does mean everything, from bright and accurate kitchen lighting through to warm and cozy bedroom lighting with LED bulbs for all existing light fittings. To reduce your energy consumption without making sacrifices.

**10. Conclusions:**

The digital voltmeter by using VHDL programming language has been studied successfully. It worked as highly calibrated accurate digital voltmeter rather than other IC based voltmeter. It is used to measure voltage of any device

**11.0 Limitations:**

1. VHDL kit is high cost.
2. We can obtain the voltage in limiting range.

**12.0 Future Enhancement:**

In future, we can design Digital Voltmeter to display fraction number by using VHDL programming.

**13 References**

1. Microcontrollers by -Ajay V. Deshmukh
2. The 8051 microcontroller by -M. A. Mazidi
3. VHDL programming by -Douglas L. Perry

## Energy Dispersive Analysis of X-rays (EDAX) an Ideal Tool for elemental mapping of Mixed- Metal Oxides Synthesized by Sol-Gel Method

U. D. Kadam\*, B. S. Shirke, S. M. Arde, R. S. Pandav\*

Department of Chemistry, Y. C. Warana Mahavidyalaya, Warananagar (MS) India.

### Abstract:

Since last two to three-decade enormous work has been done on nanoscale mixed metal oxide because of their interesting physico-chemical properties owing to their extremely small size and large surface area. Particles of nanometer size began to attract an attention of researchers of different field in the last 15-20 years. Their physical properties like magnetic permeability, dc electrical resistivity and dielectric properties make them useful in electromagnetic devices and capacitors. Due to novel properties exhibited by this material, there has been growing interest in synthesis of this kind of material. Along with their technological importance as magnetic materials, mixed metal oxide also established photocatalytic and gas sensing properties. All these properties mainly depend upon their chemical composition and microstructure of the materials. Desired composition is detected by Energy Dispersive Analysis of X-rays (EDAX).

**Key words :** Metal oxide, Composition, EDAX technique.

### Introduction

Mixed-metal oxides are an important class of compounds in solid state and materials chemistry. Mixed-metal oxides of the general formula,  $AB_2O_4$  have a wide range of electrical and magnetic properties. These metal oxides have been investigated in the past because of their potential use as logic- or memory-components or as lasers and light modulators in optical materials. The surface acidity/basicity of some of the alkaline earth and transition metal oxides has been correlated with their catalytic activity. The surface electron donor properties of some of the metal oxides are also correlated with their acid-base behavior and catalytic activity. Since the dawn of civilization man has been trying to understand nature and properties of solids, providing a basis for developing new tailor made materials with derived properties which can be converted into useful products by controlling their metallic constituents. These systems are of immense technological importance due to their diverse applications in sensors, transducers, microelectronics, magnatoelectronic devices, telecommunication systems and industrially important catalytic reactions. The interesting electrical and magnetic properties of these compounds are governed critically by their chemical composition. Hence preparation of oxides, with specific properties has gained much importance(1,2).

Spinel's have a face centered cubic crystal structure with space group  $Fd3mO_7^h$ . The structure is derived from that of mineral spinel,  $MgAl_2O_4$ . Hence the unit cell formula is  $M^{2+}_8Fe^{3+}_{16}O^{2-}_{32}$ . The 32 oxygen ions form two kinds of interstitial sites- tetrahedral or A sites (four oxygen neighbors) and octahedral or B sites (six oxygen neighbors) per unit cell. In all, there are 64 tetrahedral and 32 octahedral sites. Mixed metal oxide systems of transition metal ions like  $Cu^{2+}$ ,  $Co^{2+}$ ,  $Zn^{2+}$ ,  $Mn^{3+}$ ,  $Ni^{2+}$  and  $Fe^{3+}$  etc. have been investigated. The present work consists of the method of preparation of spinel's elemental mapping of resultant composition with EDAX(3).

### Synthesis Technique:

Mixed metal oxide with composition  $NiMn_xFe_{2-x}O_4$  where  $x = 0.0, 0.5, 1.0, 1.5$  and  $2.0$  was synthesized by sol-gel auto- combustion technique. Calculated amount of A.R. Grade citric acid ( $C_6H_8O_7$ ) and metal nitrates were used as starting materials. The above nitrates were taken in appropriate proportions and mixed together after dissolving them into the doubly distilled water. An aqueous solution of citric acid was added slowly with constant stirring to the metal nitrate solution and ammonia was added to adjust the pH at 10. The mixed solution was kept on hot plate with continuous stirring at  $70^\circ C$ . During the evaporation the solution becomes viscous and finally forms gel. The so formed gel was heated at  $110^\circ C$ , when all remaining water was released from the mixture, the gel automatically burnt with glowing flints. The auto-combustion was completed within a minute yielding the brown pulpy powders. The above synthesized powders were heated separately at  $700^\circ C$  for 8 hours to get final product. (4)

### Energy Dispersive Analysis of X-rays (EDAX):

EDAX is a chemical microanalysis technique. The technique utilizes X-rays that are emitted from the sample during bombardment by the electron beam to characterize the elemental composition of the analyzed volume. Features or phases as small as about  $1 \mu m$  can be analyzed using EDAX [5]. When the sample is bombarded by the electron beam of the SEM, electrons are ejected from the atoms comprising the sample's surface. A resulting electron vacancy is filled by an electron from a higher shell, and an X-ray is emitted to balance the energy difference between the two electrons. The EDAX X-ray detector measures the number of



emitted X-rays versus their energy. The energy of the X-ray is characteristic of the element from which the X-ray was emitted. A spectrum of the energy versus relative counts of the detected X-rays is obtained and evaluated for qualitative and quantitative determinations of the elements present in the sampled volume [6].

There are four primary components of the EDS setup, they are: the beam source; the X-ray detector; the pulse processor; and the analyzer as shown in Fig. An EDS system is mostly equipped with scanning electron microscopes. A detector is used to convert X-ray energy into voltage signals; this information is sent to a pulse processor, which erases the signals and passes them onto an analyzer for data display and analysis. EDS gathers a spectrum of all elements, within limits, of a sample. The quantitative analysis of the system was carried out using Energy Dispersive X-ray Analysis (EDAX or EDS) for some samples to study the stoichiometry of the material.

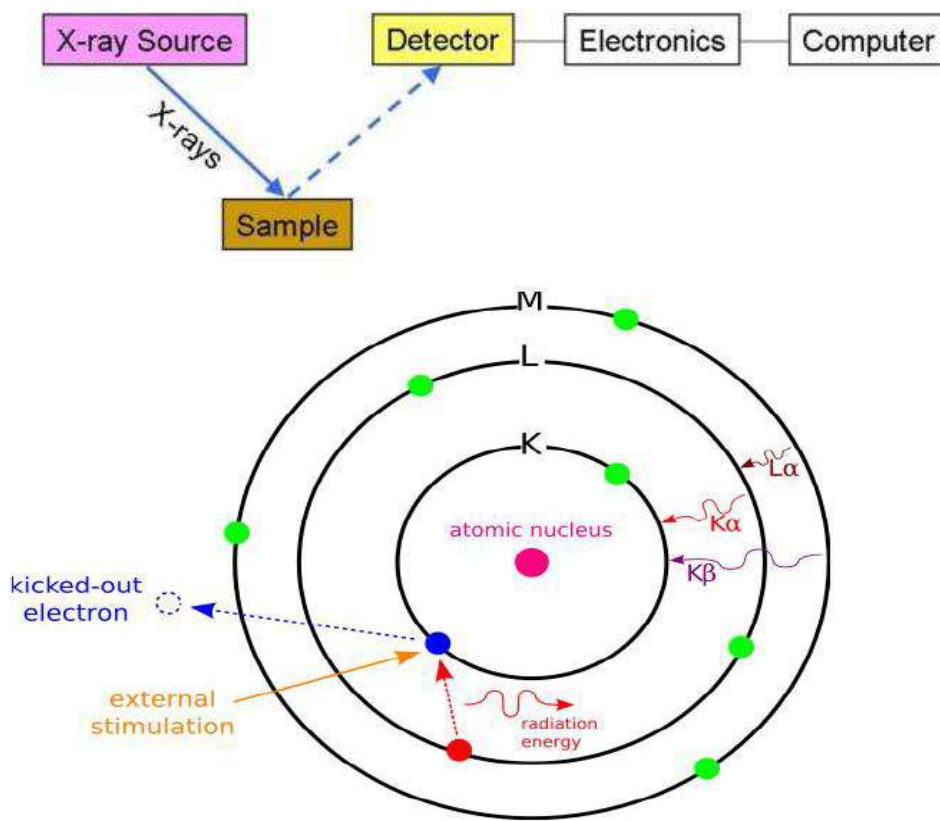

### Elemental mapping:

The composition of the nanocrystalline metal oxides has been determined using the energy dispersion x-ray analysis (EDAX). The X-ray spectra for  $x = 0.0, 1.0$  and  $2.0$ , compositions are shown in **Fig. (a-c)**. From the EDAX spectra, the presence of Ni, Mn, Fe and O is confirmed in the sample. The data of the EDAX analysis for all three samples are given in **Table** and it is revealed that, the experimental value of the atomic percentage is in well agreement with assumed stoichiometry in preparation.

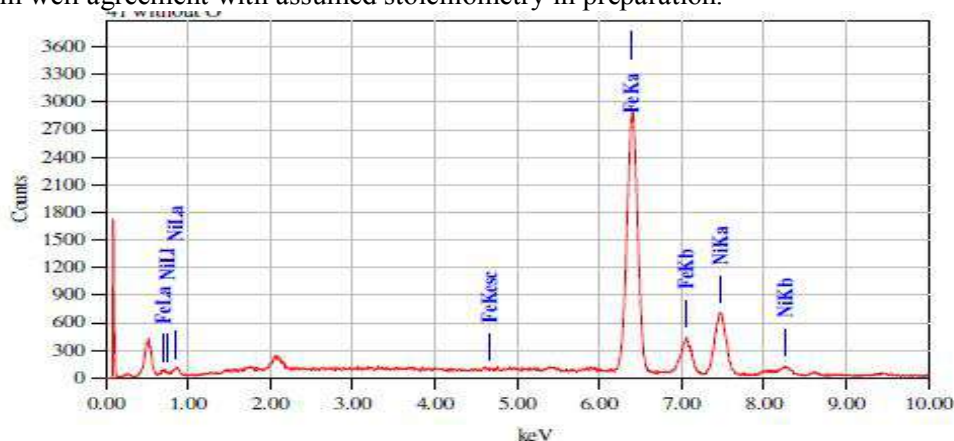

a)  $x=0.0$

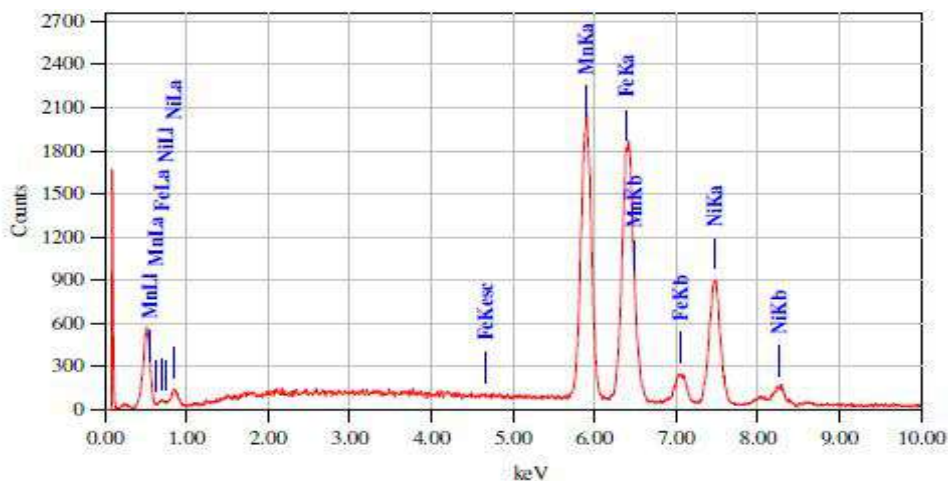

b)X=1.0

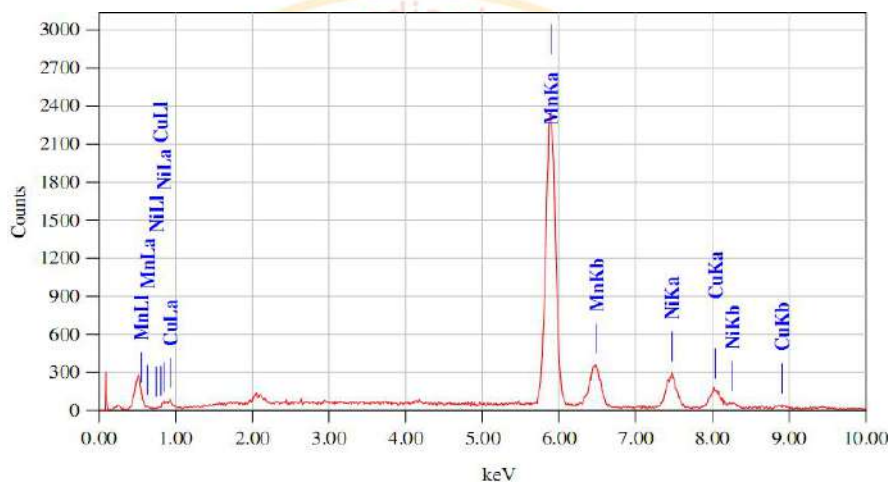

c)X=2.0

Fig. EDAX graphs for the system  $\text{NiFe}_{2-x}\text{Mn}_x\text{O}_4$  (x=0.0, 1.0 and 2.0)

Compo- sition (x)	Atomic % for element					
	Ni		Mn		Fe	
	Expt.	Thero.	Expt.	Thero.	Expt.	Thero.
0.0	28.57	33.33			71.43	65.56
0.5	29.79		35.70	32.41	34.50	32.95
1.0	33.54		6.46	65.13		

**Table.** Atomic percentage value for the  $\text{NiFe}_{2-x}\text{Mn}_x\text{O}_4$  System by EDAX analysis**Conclusion:**

The data of the EDAX analysis for all three samples are given in **Table** and it is revealed that, the experimental value of the atomic percentage is in well agreement with assumed stoichiometry in preparation.

**Reference :**

1. A. R. West, Basic Solid State Chemistry John Wiley and Sons. Ltd. (1988).
2. B. Viswanathan and V. R. K. Murthy, Ferrite Materials: Science and Technology (Narosa Publishing House, New Delhi, 1990).
3. K. J. Klabunde, Nanoscale Materials in Chemistry, Wiley- Interscience, New York, 2001
4. C. N. R. Rao and J. Gopalkrishnan, New directions in Solid State Chemistry (Second Edn.) Cambridge University press, Cambridge. (1997).
5. J. D. Corbalt, Solid State Chemistry Techniques, Clarendon press, Oxford (1987).
6. J. R. Fryer, Chemical Applications of Transmission Electron Microscopy, (Academic Press, San Diego, 1979).

## Evaluation of the Underground Water Quality from various regions of Kolhapur City

P.P.Pujari

(Head, Department of zoology)

D.K.A.S.C.College, Ichalkaranji. Dist Kolhapur (M.S.)

### Abstract

Presently river Panchganga is severely polluted because of direct discharge from industrial effluents domestic waste, hospital waste, similarly agricultural runoff mixes large number of pollutants in water. Hence study has been undertaken to evaluate underground water quality by physico-chemical and bacteriological parameters from some bore wells of various regions of Kolhapur such as Urban, Slum, Agricultural, Industrial region. In Urban region bore well near domestic sewage, Slum region namely Rajendranagar is influenced by anthropogenic activities like bathing, washing cloths and utensil near water resource. In this region drainage and poor sanitation contaminate the ground water resources, some bore wells are near public toilet. The dumpy region near source deteriorates the ground water. Residents from this region use the bore well water for domestic as well as drinking purpose because of acute shortage of water supply from Kolhapur Municipal Corporation (KMC). So to monitor the contamination of water and evaluate the quality of water the representative sampling sites are selected from this region. The water sample analyzed for physico-chemical and bacteriological parameters. Certain physico-chemical parameters are beyond the permissible limit recommended by World Health Organization (WHO) and Indian Standard Institute (ISI).

Bacteriological analysis reveals that water from bore wells were contaminated by fecal coliform bacteria.

### Introduction:

Safe drinking water is basic need of human being. It is available from surface and underground resources. It fulfils the agricultural, industrial and domestic needs. Underground water quality depends upon geological origin and presence of chemical substances as studied by number of workers (Garg 2003). Direct discharge from Municipal waste, Industrial waste from metal processing units such as electroplating units automobile servicing centers, dyes industries, tanneries and other domestic sewage, agricultural runoff from agriculture areas mixes the large number of pollutants in the river Panchganga. Generally ground water is recharged by leakage from river channels in certain geological situations, so ultimately bore water is also contaminated. Hence the residents of Kolhapur city complaints about quality of drinking water.

In some areas due to acute shortage of KMC water supply, residents used bore well water for domestic and drinking purpose. In these regions the lack of sanitation and drainages contaminate the ground water resources. Therefore the present study has been undertaken to evaluate the quality of bore well water from slum area of Kolhapur city.

### Study Area:

Kolhapur is located in South Maharashtra at an altitude of about 550 meter above MSL at latitude 16°84' to north and longitude 74°81' east. The study areas selected for bore well water analysis is slum area named Rajendranagar, Industrial area named Udyamnagar, Urban area (Near B.T.College), Agriculture area Vadanage.

These four representative sampling sites of bore wells were selected to evaluate drinking water quality.

### Material And Method:

The samples from selected bore well were collected for assess the quality of water from slum area. Samples were collected in sterilized 2-L plastic cans and analyzed as per the procedure given in standard method for examination of water and waste water by APHA (1985) Washington DC. Physico-chemical parameters such as Electric Conductivity (EC), pH, dissolved oxygen analyzed at site and COD, BOD, Chloride, Alkalinity, Sulphate, Total Hardness, Calcium, Magnesium, Sodium in Laboratory. (APHA 1985)

For Bacteriological analysis water samples were collected in separate sterilized glass bottles, MPN of coliform bacteria, SPC of total coliform, E-coli estimated by multiple fermentation technique with Mac-Conkey's broth (Hi-media), Nutrient agar medium and Endoagar medium respectively. *Salmonella* sp. isolated with Bismuth sulphite agar medium by four quadrant method.

**Table No.1 Average value of physico-chemical parameters of water in Four regions of Kolhapur city.**

Parameters	Urban	Slum	Agricultural	Industrial
pH	7.31± 0.21	6.91±0.30	7.06±0.45	7.19±0.29
EC (µmhos/cm)	947.58±103.5	751.58±164.2	827.75±174.7	649.83±139.4
TDS	590.67±75.36	502.75±105.2	591.33±104.1	489.17±187.32
DO	3.034±0.98	3.25±1.04	3.20±0.85	3.57±1.14

BOD	5.76±2.05	3.64±2.03	9.22±2.94	4.42±2.99
COD	25.12±8.81	21.35±12.58	28.63±6.47	24.68±11.2
Chloride	119.68±13.22	89.52±21.24	87.24±15.89	60.22±18.21
Alkalinity	215.08±38.60	312.55±47.21	313.13±59.37	241.74±24.10
Sulphate	118.41±41.85	98.02±44.62	100.51±33.53	91.30±37.97
Total Hardness	243.53±101.25	315.35±77.68	350.025±79.7	397.89±60.65
Calcium	53.66±25.46	74.45±15.34	82.86±20.34	52.03±24.08
Magnesium	26.72±11.79	31.56±12.10	34.86±14.13	25.22±13.42
Sodium	70.58±31.42	31.91±10.63	58.58±22.05	50.83±12.26

Values are expressed as Mean ± SD. All values are in mg/l except pH.

**Table No.2 Seasonal variation of Bacteriological analysis in Various regions.**

Parameters	Sites Season	Various regions			
		Uran	Slum	Agricultural	Industrial
MPN /100ml faecal coliform	S	45	70	25	70
	R	20	85	50	25
	W	Nil	40	10	5
SPC/ml Total coliform	S	Nil	Nil	Nil	Nil
	R	1000	800	700	500
	W	Nil	Nil	Nil	Nil
E. coli/ml	S	Nil	Nil	Nil	Nil
	R	2	10	2	Nil
	W	Nil	Nil	Nil	Nil
Salmonella Sp./ml	S	Nil	Nil	Nil	Nil
	R	14	16	10	12
	W	Nil	Nil	Nil	Nil

### Result And Discussion:

The results of physico-chemical and bacteriological analysis of bore well water samples are depicted in table No.1 and 2 respectively.

In present investigation pH of water samples ranged from 6.93±0.30 to 7.31 ±0.29. The limit of pH value for drinking water is specified at 6.5 to 8.5 (ICMR, WHO 1975). The pH of all bore well water samples are within the prescribed limit of ICMR and WHO 1975. pH is important parameter to evaluate acidic and alkaline nature of water. It is important in regulating respiration and enzyme system (Fokmane and Mohmed 2001) pH has no direct adverse effect on human health (Khadsan & Khadu 2003), but all biochemical reactions are sensitive to the variation of pH.

Electric conductivity (EC) is an important parameter to assess the water quality. In the present investigation, EC value recorded as 947.58±103.5, µmhos/cm 751.58±164.2µmhos/cm, 827.75±174.7mhos/cm and 649.83± 139.4µmhos/cm site I, II, III, & IV sampling site respectively. The permissible limit of WHO standard for conductivity of drinking water is 300 µmhos/cm. All bore well water sample cross the permissible level might be due to waste deposit near bore wells. High conductivity is due to ground water recharges as well as solubilized mineral from underground soil structure (Sarma *et al.* 2002). The high values of EC are due to high concentration of ionic constituents present in water reflect salinity, intrusion as well as pollution by industrial and domestic waste (Abbasi and Vinithan, 1999).

Total dissolved solids (TDS) are an important parameter in drinking water quality standards. It develops particular taste to the water. The TDS value ranged from 439.17 ± 187.32 to 591.33 ± 104.4 mg/L. The higher values of dissolved solids can be related to solid waste deposits near bore wells (Sharma and Kaur 1998, Mehta 2003), Dissolved oxygen ranged from 3.034 ± 0.98 to 3.57 ± 1.14 mg/L. The recommended dissolved oxygen limit for all domestic purposes is 4 to 5 ppm (Garg *et al.* 1998). Low DO clearly indicate the pollution due to sewage and domestic waste seepage (Hegde *et al.* 1992, Olaniya *et al.* 1977, Pradhan *et al.* 1998). In present investigation BOD value are ranged from 3.64 ± 2.03 to 9.22 ± 2.94 mg/L. The recommended permissible value of BOD is 2.0 mg/L as per ISI standards. All water samples showed values of

BOD beyond the ISI standard. More BOD indicates that water sources are polluted due to increased leaching of organic matter from dumping sites & biodegradable waste from sanitary waste.

Chemical oxygen Demand (COD) is important water quality parameter in deciding to the pollution load of water. In present investigation the average COD values in all four sites ranged from  $21.35 \pm 12.58$  mg/L to  $6.47$  mg/L. The COD values more than  $1$  mg/L are due to pollution. (Turneasure and Russel 1948) The average COD values in all sites is beyond the guideline of WHO. It should not exceed more than  $10$  ppm limit. The average chloride concentration in bore well water ranges between  $60.22 \pm 18.21$  to  $119.68 \pm 13.22$  mg/L. In the present study the phenolphthelin alkalinity is zero, indicating absence of any hydroxide and carbonate ions. Bicarbonate that is total alkalinity ranges from  $215.08 \pm 38.60$  to  $313.13 \pm 59.37$  mg/L in four sites. The ISI limit for alkalinity is  $50-200$  mg/L. It means water sample of bore wells have higher alkalinity which can be attributed to concentration of calcium and magnesium salts in water (Maniraskum 1984).

The sulphate may be present in sedimentary rock and in minor quantities in Igneous rock the average sulphate value ranges from  $91.30 \pm 37.97$  to  $118.41 \pm 41.85$  mg/L in four sampling site. All values are within permissible limit.

The total hardness value ranged from  $236.94 \pm 102.44$  to  $350.025 \pm 79.7$  mg/L. The BIS and WHO permissible limit of total hardness in drinking water is  $300$  mg/L. Water sample from site II & III shows the hardness of water beyond permissible limit. Hardness of water is an important parameter determining suitability of water for drinking and domestic purpose. Park and Park (1986) observed correlation between hardness of water and its role in heart and Kidney diseases. The calcium and magnesium concentration is within limit of WHO & BIS standard.

The low content of calcium in drinking water may cause rickets and defective teeth. It is essential for nervous system, cardiac function and in coagulation of blood (Khurshid et al 1997, Garg 2003). Excess calcium leads to urinary calculi (Taquikhan 1986). In human body excess calcium causes hypercalcemia, coma and death (Dasgupta et al 2001). Human body requires approximately  $0.7$  gm to  $2.00$  gm of Calcium per day as a food element.

In present investigation the average value of sodium ranges between  $31.91 \pm 10.63$  to  $70.58 \pm 31.42$  in four sites which are within the permissible limit.

Microbiological analysis is an important study to ensure the safety of potable water. MPN of coliform is important microbiological parameter from public health point to assess any contamination of drinking water with sewage or excretory waste. In slum area MPN count was maximum in rainy season at slum & agricultural region and in summer season at urban & industrial regions. Bore well water in these areas were fecal contaminated. MPN of coliform ranges from  $25/100$  ml to  $85/100$  ml in rainy season. The coliform bacteria include the genera *Escherichia*, *Citrobaetor*, *Enterobactor* and *Klebsidella*. These pathogenic bacteria causes diseases such as typhoid, fever dysentery, diarrhea cholera etc. (Trivedi & Goel 1986). In present study all bore well water sample showed MPN of coliform beyond the safe limit of WHO standard.

SPC helps in the measurement of density of coliform bacteria. SPC count is maximum in rainy season. *E. coli* reported in rainy season. *Salmonella* sp. was detected in rainy season. All bore well water was heavily contaminated by *Salmonella* sp. According to Isolation Hospital record most of the patients were suffered by typhoid and gastrointestinal disorders during rainy season from these areas which are positively correlated with our findings.

### Conclusion:

From the study of physico-chemical and bacteriological parameters, it is concluded that the bore well water is unfit for drinking purpose. Some physico-chemical parameters such as Electric conductivity, TDS, BOD, COD, Alkalinity, Total hardness showed values beyond the standard limit of WHO, ICMR & ISI. Dissolved oxygen, chlorides, Calcium and Manganese values are within permissible limit. All bore well water showed, MPN of coliform, SPC of coliform, *E. coli* beyond the safe limit of WHO standard. *Salmonella* sp. is detected in all water samples which is positively correlated with hospital record.

Most of bore well (Hand pump) of Municipal Corporation are located at improper location, near public toilet, solid dump, garbage dump and are fecal contaminated. Most of the people depending upon bore well water sources in some regions are suffered from water borne diseases like dysentery, Diarrhea, Typhoid and Jaundice. Hence over all water quality is rated as very poor from WQI, Severally polluted and unfit for human consumption.

**References:**

1. APHA, 1998. Standard methods for examination of water and wastewater, American Public Health Association, Washington, D.C.
2. Dasgupta Adak, M. and K.M. Purohit 2001. Assessment of the water quality in Rajangpur Industrial Complex-II, Metallic parameters, *Poll. Res.* **20**(4) : 575-581.
3. Fokmare K. and M. Mohmad 2001. Comparative studies of physico-chemical and bacteriological quality of surface and ground water. *Poll. Res.*, **20** : 651-655.
4. Garg, V.K.; Deepshikha, Dahiya S. and Chowdhary A. 1998. Groundwater quality in rural areas of Jind district, Haryana. *J. of Env. And Poll.* **5** (4) : 285-290.
5. Garg s.s 2003 Water quality of wells and bore wellsof 10 selected locations of chitrakoot region. *Indian Jr.Env.Prot* 10 (9):672-676.
6. Hedge S.H.; S.C. Puranik and A.K. Abbi 1992. Study of ground water quality deterioration in Hubli city area. *Indian J. Env. Health*, **28** : 214-224.
7. ICMR 1975. Manual of standards of Quality of drinking water supplies (2<sup>nd</sup> edn.)
8. Khadson R.E. and Mangesh V. Kadu 2003. Drinking Water Quality Analysis of some Bore well water of Chikhali Town, Maharashtra. *Jr. Industrial Poll. Control*, **20** (1) : 31-36.
9. Khurshid S.; Zaheeruddin and A. Basheer 1997. Pollution assessment and water quality status in parts of Cochin. *Indian J. Env. Prot.*, **18** (4) : 246-249.
10. Manivaskam, N. 1984. Physico-chemical examination of water sewage and industrial effluents, Pragati Prakashan, Meerut p. 46.
11. Pradhan S.K.; D. Patnaik and S.P. Rout 1998. Ground water quality - An assessment around a phosphatic fertilizer plant at Paradip.
12. Sarma, C. D.K.; Deka and K.G. Bhattacharya 2002. Quality of water in a few urban drinking water sources.
13. Sharma B.K. and Kaur 1998. Environmental Chemistry. *Goel. Pub. House Meerut* p. 40.
14. Trivedy R.K. and Goel P.K. 1986. Chemical and biological methods for water pollution studies, Environmental Publications, Karad, p.35-38.
15. Taquikhan M.M. 1986. Presidential address section of Chemistry 73<sup>rd</sup> Indian Science Congress, Delhi.
16. WHO 1971. International Standards for drinking water (3<sup>rd</sup> edn.). World Health Organization, Geneva.

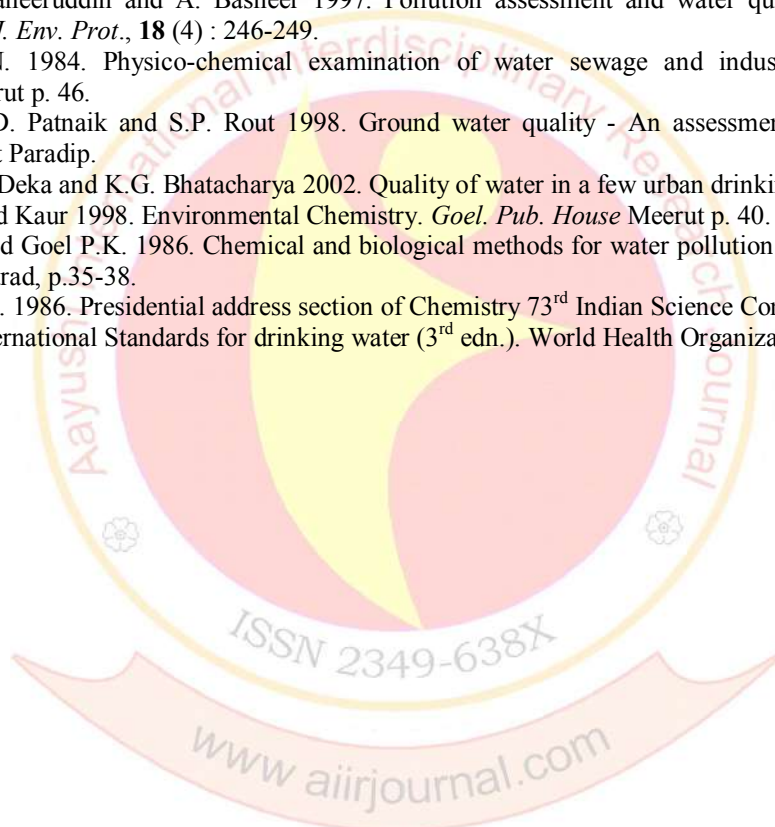

## Adsorption of Rhodamine B from Aqueous Solution onto Low-Cost Cerium Oxide Nanoparticles

B.S. Shirke<sup>\*</sup>, A.A. Kabure, M.G. Chikalkar, S.R. Mane and K.M. Garadkar

<sup>\*</sup>Nanomaterials Research Laboratory, Department of Chemistry, Yashwantrao Chavan Warana Mahavidyalaya, Warananagar

### Abstract

Nanoparticles of cerium oxide with a narrow size distribution were prepared by employing microwave assisted sol-gel method using cerium nitrate solution with ammonium reagent. The product was characterized by X-ray diffraction (XRD), energy dispersive analysis using X-rays (EDAX), scanning electron microscopy (SEM). The adsorption process was tested by using CeO<sub>2</sub> nanocrystals to remove rhodamine B (Rh B) upto the 20 mg/dm<sup>3</sup>. UV-Visible absorption spectrum confirms that upto 95% of Rh B aqueous solution could be removed with 100 mg of the as-prepared CeO<sub>2</sub> nanocrystalline within 60 minutes.

**Keywords:** Ceria; Precipitation; Adsorption; Surface Morphology; X-ray Diffraction

### 1. Introduction

The effluent containing dyes generated by various industries like paints, pulp and paper, carpet and printing emerged into various ecosystems lead to some hazards problem for all ecosystems, cause the need for the development of new and efficient method to remove these pollutants from waste water and soil. Among different dyes the classes of anionic, cationic, non-ionic and zwitterionic the cationic dyes are more toxic than anionic dyes [1]. Because stability of dyes to light, heat and oxidizing agents and their resistance to biodegradation they are harmful to aquatic life and the primary and secondary treatment systems are insufficient for their removal from waste water treatment. In particular, rhodamine B used in the textile, printing and paint industries from wastewater using microbial biomass remains unexplored [2].

Ceria is an oxide with important applications in areas of catalysis, electrochemistry, photochemistry and materials science [3]. In its most stable phase, bulk CeO<sub>2</sub> adopts a fluorite-type crystal structure in which each metal cation is surrounded by eight oxygen atoms [4]. The band gap of pure ceria is 5.0 eV, but crystal defects or impurities can transform the material in a n-type semiconductor [5]. Experimental and theoretical studies indicate that bulk CeO<sub>2</sub> is not a fully ionic oxide. The photoelectron spectroscopy and optical reflectivity measurements show a strong hybridization of the metal and oxygen orbitals of the valence band, although dominated by 2p character of oxygen, still contains a significant amount of metal character [6]. Thus, the charge on the metal cations is probably much smaller than the formal value of +4 frequently assigned, and CeO<sub>2</sub> is best described as an ionocovalent compound or covalent insulator [7]. One of the most interesting properties of ceria is its ability to undergo a facile conversion between +4 and +3 formal oxidation states [8]. Because of this, ceria is a key component in the so-called three-way catalytic converter (TWC) commonly used to reduce the emissions of CO, NO<sub>x</sub>, and hydrocarbons from automobile exhaust, or used as a base material of electrolytes and electrodes in solid oxide fuel cells (SOFC) [9]. Ceria-supported noble metal catalysts are capable of storing oxygen under oxidizing conditions and releasing oxygen under reducing conditions through a transformation between Ce<sup>4+</sup> and Ce<sup>3+</sup> oxidation states [10].

Crystalline ceria nanoparticles have been synthesized by variety of methods such as solution precipitation, sonochemical, hydrothermal crystallization, microemulsion, mechanochemical, thermal decomposition, spray pyrolysis, sol-gel, thermal hydrolysis, and solvothermal synthesis [11-17]. These techniques rely mainly on high pressure, or salt-solvent mediated high temperature, or surface capping agent, and the sizes of ceria particles are relatively large. Therefore, seeking a simple approach for low-cost, lower-temperature preparation, large-scale, controlled growth of ceria nanostructures at atmospheric pressure is essential [18]. However, microwave synthesis is very beneficial to find a fast, simple and energy efficient approach to produce fine CeO<sub>2</sub> nanoparticles [19]. It is relatively new method to produce inorganic compounds for material processing to enhance the material properties as well as economic advantages through energy saving and acceleration of product development. Microwave heating offers several potential advantages over conventional heating for inducing or enhancing the rates of chemical reactions [20-22].

As a result, removal of dyes from wastewater becomes difficult by conventional techniques, such as aerobic digestion etc [23]. Current research is now focused on the removal of dye from effluent using the adsorption technique, which does not generate a huge amount of sludge or harmful substances [24]. Activated carbon is the most efficient and popular choice as a adsorbent but due to high cost and large requirement restrict its use in many countries including India. Thus, there is much interest in the development of new adsorbents for the treatment of biological and industrial waste [25]. Due to the low adsorption capacity of these materials, a huge amount is required; hence, highly efficient and economically viable adsorbents are needed for the removal of dyes [26]. The three-dimensional (3D) flowerlike ceria is able to remove toxic ions

from water with higher removal capacity than bulk materials [27]. In this communication a simple method for the preparation of ultrafine nanocrystalline cerium oxide is reported and the resulting CeO<sub>2</sub> nanocrystals could effectively remove organic dye rhodamine B (RhB) from wastewater at neutral pH.

## 2. Experimental Details

### 2.1. Materials and chemicals

All the chemicals used for the preparation were of analytical grade. It includes cerium nitrate (99%), propylene glycol, ammonia and rhodamine B. All the solutions were prepared in millipore water obtained from ultrapure water system.

### 2.2. Preparation of CeO<sub>2</sub> nanoparticles

Monodispersed nanocrystalline CeO<sub>2</sub> powder was prepared by controlled addition of aqueous ammonia to a mixture of 0.1M aqueous solution of cerium nitrate and propylene glycol until the solution reached pH = 10. The ratio of concentration of propylene glycol to cerium nitrate solution was kept 1:1. The special arrangement was made to add dropwise aqueous ammonia into the solution with constant stirring. After complete precipitation, the precipitated hydroxide was washed with distilled water. Then pure hydroxide in a glass beaker was placed in a microwave oven (in put power 600W) about 30 minutes with on-off cycle. The Phase purity and the degree of crystallinity of the resulting CeO<sub>2</sub> sample were monitored by XRD analysis.

### 2.3. Characterization of CeO<sub>2</sub> Nanoparticles

The X-ray diffraction of the powder samples were measured on Philips PW 3710 diffractometer with Cr K $\alpha$  radiation ( $\lambda = 2.2897 \text{ \AA}$ ). The XRD pattern was recorded between 10 to 100° with the scanning speed of 1°/min. The EDAX was recorded in the binding energy region between 0–20 keV. The surface morphology and chemical composition of the powder were analyzed using a scanning electron microscope (JEOL, JSM-6360, JAPAN). Before scanning, the powder was sputter coated with platinum in order to increase conductivity of the material.

### 2.4. Rhodamine B (RhB) adsorption

Mesoporous CeO<sub>2</sub> nanocrystals were agitated in 100 mL of aqueous solution with concentration 20 mg/L of RhB under constant mechanical stirring. The adsorption bottles were covered with carbon paper to prevent the photodegradation of RhB. At different time intervals, 5 mL suspension was collected, filtered through a 0.45 m membrane and finally analyzed by a UV-Visible spectrophotometer immediately. The structure of the RhB molecule is illustrated below.



## 3. Results and discussion

### 3.1. The XRD of the nanoparticles

Fig.1 shows the X-ray diffractogram of the as prepared powder of CeO<sub>2</sub> nanoparticles synthesized by microwave assisted sol-gel method. The CeO<sub>2</sub> nanoparticles are crystalline in nature with d values 3.13, 2.70, 1.91 and 1.63 Å. The synthesized samples by microwave confirmed the formation of face centered cubic structure of CeO<sub>2</sub> nanoparticles. The determined characteristics 2 $\theta$  values and [hkl] planes are 42.87° [111], 50.17° [200], 73.86° [220] and 89° [311] respectively and lattice parameter is 5.42 Å. The particle size of CeO<sub>2</sub> powder was calculated by using Scherrer's relation,

$$t = 0.9\lambda / \beta \cos \theta$$

where  $\lambda$  is wavelength of X-ray (Cr K $\alpha$  line, 2.28 Å),  $\beta$ -full width at half maximum in radian and  $\theta$  is the Bragg's angle of the peak. The average particle size of CeO<sub>2</sub> nanoparticles was found to about 10 nm.

### 3.2. Compositional analysis and surface morphology of CeO<sub>2</sub> nanoparticles

The EDAX was recorded in the binding energy region between 0–20 keV and shown in Fig. 2. The peak from the spectrum reveals the presence of Ce and O at 4.837 and 0.525 keV respectively. The atomic % of Ce and O is 35.97 and 64.03 respectively. The present composition of Ce and O reveals that, the formation of non-stoichiometric CeO<sub>2</sub> which is superior for adsorption of toxic ions from wastewater.



Fig. 3 shows the surface morphology (SEM) of CeO<sub>2</sub> nanoparticles at different magnification, which reveals the particle size was found to be about 10 nm with spherical shape and narrow size distribution. The value of particle size observed from SEM was in good agreement with the XRD results. It reveals that the microwave hydrolysis makes it possible to obtain particles of predominantly spherical shape with a narrow size particle distribution.

### 3.3. Removal of rhodamine B

The effect of adsorption of organics substance on the surface of CeO<sub>2</sub> has become a focus of attention since the early study of the photocatalytic oxidation. As compared to photodegradation of organic compound, adsorption process is easy, inexpensive and effective at large scale. Both the reaction mechanism, under either UV or Visible irradiation, suggests that preliminary adsorption of organic substance on the CeO<sub>2</sub> surface exhibits an advantage for high efficient oxidation. The removal of dye pollutants are also of great importance for wastewater treatment. Rhodamine B, a common cationic dye used in textile industry, is one of the most notorious contaminants in aquatic environments. In this study, synthesized CeO<sub>2</sub> nanocrystals are further used to remove RhB. The absorption spectrum of RhB solution was characterized by its characteristic absorption at 555 nm, which was attributed to the chromophore containing azo linkage of the dye molecules. UV-Visible absorption spectrum represented in Fig. 4 confirms that upto 95% of RhB aqueous solution could be removed with a 100 mg of the as-prepared CeO<sub>2</sub> nanocrystalline powder within 60 minutes. The reasons may account for the efficient removal of RhB with CeO<sub>2</sub> nanocrystals are facilitate the adsorption of RhB due to the oxygen vacancies on the surface of CeO<sub>2</sub> nanocrystals. These abundant surface oxygen vacancies could produce strong electrostatic attraction with the cationic groups of RhB as well as hydrogen bonding with the nitrogen atoms of RhB [18]. RhB adsorbs on the surface of CeO<sub>2</sub> particles with diethylamino group. In case of adsorption of a diethylamino group, RhB initially has a high selective stepwise deethylation process in which the various deethylated intermediate species have an adsorption/desorption equilibrium between CeO<sub>2</sub> surface and bulk solution. This work provides a possibility that we can utilize nanometal oxides to modify the surface area to adsorb effectively the special colored organic molecules.

#### 3.3.1. Adsorption isotherm

The adsorption equilibrium models often provide insight into the sorption mechanism, surface properties and affinity of adsorbent. The most commonly used equilibrium models are Freundlich and Langmuir isotherms. The Freundlich isotherm was represented by,

$$\log Q_0 = \log K_f + 1/n \log C_0$$

where Q<sub>0</sub> is the amount of RhB dye adsorbed (mg/g), C<sub>0</sub> is the equilibrium concentration of dye in solution (mg/L), K<sub>f</sub> and n are constants incorporating the factors affecting the adsorption capacity and intensity of adsorption, respectively. Linear plot of log Q<sub>0</sub> versus log C<sub>0</sub> from Fig.5 shows that, the adsorption of RhB dye obeys the Freundlich adsorption isotherm. The values of K<sub>f</sub> and n shows increase in negative charges on the adsorbent surface that makes electrostatic force like Vanderwaal's between the cerium oxide surface and dye ions. The values of n are greater than one indicating the adsorption is much more favorable.

The Langmuir isotherm represented by the following equation,

$$C_0 / Q_0 = 1 / K_L + (C_L / K_L) C_0$$

where C<sub>0</sub> is the equilibrium concentration (mg/L), Q<sub>0</sub> is the amount adsorbed at equilibrium (mg/g) and, K<sub>L</sub> and C<sub>L</sub> are Langmuir constants related to adsorption efficiency and energy of adsorption, respectively. From Fig. 6, the linear plots of C<sub>0</sub>/Q<sub>0</sub> versus C<sub>0</sub> suggest the applicability of the Langmuir isotherms. The values of K<sub>L</sub> and C<sub>L</sub> were determined from slope and intercepts of the plots. From the results, it is clear that the value of adsorption efficiency (K<sub>L</sub>) and adsorption energy (C<sub>L</sub>) of the CeO<sub>2</sub> are increases. From the values it can conclude that the maximum adsorption corresponds to a saturated monolayer of adsorbate molecules on adsorbent surface with constant energy and no transmission of adsorbate in the plane of the adsorbent surface. The observed C<sub>L</sub> values shows that the adsorbent prefers to bind acidic ions and that speciation predominates on sorbent characteristics, when ion exchange is the predominant mechanism takes place in the adsorption of RhB, it confirms the exothermic nature of the process involved in the system. The molecular weight, size and radii either limit or increase the possibility of the adsorption of the dye onto adsorbent. However, the values clearly show the dominance in adsorption capacity. The intensity of adsorption is an indicative of the bond energies between dye and adsorbent and the possibility of slight chemisorptions rather than physisorption. However, the multilayer adsorption of RhB through the percolation process may be possible.

### 4. Conclusions

Microwave synthesis is very beneficial to find a fast, simple and energy efficient approach to produce fine CeO<sub>2</sub> nanoparticles. The present study illustrates that the CeO<sub>2</sub> nanocrystals could adsorb RhB from

wastewater efficiently i.e. CeO<sub>2</sub> nanocrystals are novel adsorbent for wastewater treatment. Rhodamine B adsorbs on the surface of CeO<sub>2</sub> particles with diethylamino group. In case of adsorption of a diethylamino group, RhB initially has a high selective stepwise deethylation process in which the various deethylated intermediate species have an adsorption/desorption equilibrium between CeO<sub>2</sub> surface and bulk solution. This work provides a possibility that we can utilize nanometal oxides to modify the surface area to adsorb effectively the special colored organic molecules.

### Acknowledgment

One of the authors (B.S.Shirke) is thankful to UGC, New Delhi for providing the Financial Support under Minor Research Project No. 47-805/09 (WRO).

### References

1. Das SK, Ghosh P, Ghosh I, Guha AK, Adsorption of rhodamine B on *Rhizopus oryzae*: Role of functional groups and cell wall components, *Colloids and Surfaces B: Biointerfaces* 65 : 30 (2008).
2. Ansari R, Mosayebzadeh Z, Application of polyaniline as an efficient and novel adsorbent for azo dyes removal from textile wastewaters, *Chemical Papers* 65 (1) : 1 (2011).
3. Hul C, Zhang Z, Liu H, Gao P, Wang ZL, Direct synthesis and structure characterization of ultrafine CeO<sub>2</sub> nanoparticles, *Nanotechnology*, 17 : 5983 (2006).
4. Sathyamurthy S, Leonard KJ, Dabestani RT, Paranthaman MP, Reverse micellar synthesis of cerium oxide, Nanoparticles, *Nanotechnology* 16: 1960 (2005).
5. Al-Qaradawi S, Salman SR, Photocatalytic degradation of methyl orange as a model compound, *J. Photochem. Photobiol. A: Chem.*, 148 : 161 (2002).
6. Girija D, Bhojya Naik HS, Sudhamani CN, Kumar BV, Cerium oxide nanoparticles – a green, reusable, and highly efficient heterogeneous catalyst for the synthesis of Polyhydroquinolines under solvent-free conditions, *Archives of Applied Science Research*, 3 (3):373 (2011).
7. Zhang M, Juan Li, Li H, Li Y, Shen W, Morphology-dependent redox and catalytic properties of CeO<sub>2</sub> nanostructures, nanowires, nanorods and nanoparticles, *Catalysis Today* 148 : 179 (2009).
8. Wang G, Mu Q, Chen T, Wang Y, Synthesis, characterization and photoluminescence of CeO<sub>2</sub> nanoparticles by a facile method at room temperature, *Journal of Alloys and Compounds*, 493 : 202 (2010).
9. Gu H, Soucek MD, Preparation and Characterization of Monodisperse Cerium Oxide Nanoparticles in Hydrocarbon Solvents, *Chem. Mater.*, 19 : 1103 (2007).
10. Zhang F, Chan SW, Spanier JE, Apak E, Jin Q, Robinson RD, Herman IP, Cerium oxide nanoparticles: Size-selective formation and structure Analysis, *Appl. Phys.Letts.*, 80 : 127 (2002)
11. Combemale L, Caboche G, Stuergea D, Chaumont D, Microwave synthesis of yttria stabilized zirconia, *Microwave Research Bulletin*, 40 : 529 (2005).
12. Zawadzki M, A facile microwave solvothermal process to synthesize ZnWO<sub>4</sub> nanoparticles, *J. of Alloys and Comps.*, 454 : 347 (2008).
13. Garadkar KM, Shirke BS, Patil YB, Patil DR, Nanostructured ZrO<sub>2</sub> Thick Film Resistors as H<sub>2</sub>-Gas Sensors Operable at Room Temperature, *Sens. and Transducers* 110 : 17 (2009).
14. Garadkar KM, Shirke BS, Hankare PP, Patil DR, Low Cost Nanostructured Anatase TiO<sub>2</sub> as a H<sub>2</sub>S Gas Sensor Synthesized by Microwave Assisted Technique, *Sensor Lett.* 9 : 1(2011).
15. Shirke BS, Korake PV, Hankare PP, Bamane SR, Garadkar KM, Synthesis and characterization of pure anatase TiO<sub>2</sub> nanoparticles, *J. Mater. Sci.: Mater. Electron.* 22 : 821 (2011).
16. Zhang F, Yang S, Chen H, Yu X, Preparation and characterization of mesoporous MO<sub>2</sub> (M = Ti, Ce, Zr, and Hf) nanopowders by a modified sol-gel method, *Ceramic International*, 30: 997 (2004).
17. Gu F, Wang SF, Lu MK, Zhou G, Xu D, Langmuir DR, Synthesis of ZnO Nanocrystals with Hexagonal (Wurtzite) Structure in Water Using Microwave Irradiation *J. Sci.I.R. Iran*, 20 : 3528 (2004).
18. Xiao H, Ai Z, Zhang L, Facile Low-Temperature Synthesis of Ceria and Samarium-Doped Ceria Nanoparticles and Catalytic Allylic Oxidation of Cyclohexene, *J. Phys. Chem.*, 113 : 16625 (2009).
19. Das SK, Bhowal J, Das A R, Guha AK, Adsorption Behavior of Rhodamine B on *Rhizopus oryzae* Biomass, *Langmuir*, 22 : 7265 (2006).
20. Khan TA, Ali I, Singh VV, Sharma S, Utilization of Fly ash as Low-Cost Adsorbent for the Removal of Methylene Blue, Malachite Green and Rhodamine B Dyes from Textile Wastewater, *J. Envi. Protec. Sci.*, 3 : 11 (2009).
21. Arslan I, Balcioglu IA, Tuhkanen T, Mannesmann D, H<sub>2</sub>O<sub>2</sub>/UV-C and Fe<sup>2+</sup>/H<sub>2</sub>O<sub>2</sub>/UV-C versus TiO<sub>2</sub>/UV-A treatment for reactive dyewastewater, *J. Environ. Engg.*, 126 : 903 (2000).
22. Stock N, Peller J, Vinodgopal K, Kamat PV, Combinative sonolysis and photocatalysis for textile dye degradation, *Environ. Sci. Technol.*, 34 : 1747 (2000).
23. Kusvuran E, Samil A, Atanur OM, Erbatur O, Photocatalytic degradation of di- and tri-substituted phenolic compounds in aqueous solution by TiO<sub>2</sub>/UV, *Appl. Catal. B: Environ.*, 58 : 211(2005).
24. Neppolian B, Choi HC, Sakthivel S, Arabindoo B, Murugesan V, Solar/UV-induced photocatalytic degradation of three commercial textile dyes, *J. Hazard. Mater. B*, 89 : 303 (2002).

26. Akyol A, Yatmaz HC, Bayramoglu M, Photocatalytic decolorization of Remazol Red RR in aqueous ZnO suspensions, *Appl. Catal. B: Environ.*, 54 : 19 (2004).
27. Daneshvar N, Salari D, Khataee AR, Photocatalytic degradation of azo dye acid red 14 in water on ZnO as an alternative catalyst to TiO<sub>2</sub>, *J.Photochem. Photobiol. A: Chem.* 157 : 111 (2003).
28. Xiao H, Ai Z, Zhang L, Nonaqueous Sol-Gel Synthesized Hierarchical CeO<sub>2</sub> Nanocrystal Microspheres as Novel Adsorbents for Wastewater Treatment, *J. Phys. Chem. C*, 113: 16625 (2009).

### Figure Captions

- 1] Figure 1. XRD pattern of the nano CeO<sub>2</sub>.
- 2] Figure 2. EDAX of CeO<sub>2</sub> nanoparticles.
- 3] Figure 3. SEM image of the CeO<sub>2</sub> nanoparticles.
- 4] Figure 4. Absorption spectrum of aqueous solution of RhB in the presence of CeO<sub>2</sub> nanocrystals at different times.
- 5] Figure 5. Freundlich adsorption isotherm for RhB by CeO<sub>2</sub>
- 6] Figure 6. Langmuir adsorption isotherm for RhB by CeO<sub>2</sub>

### Figures

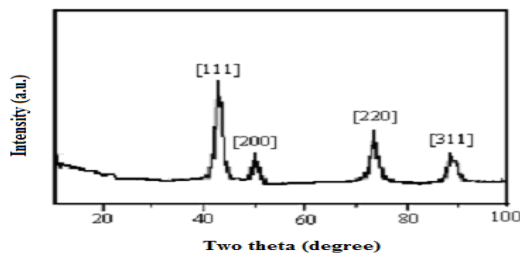

Fig. 1

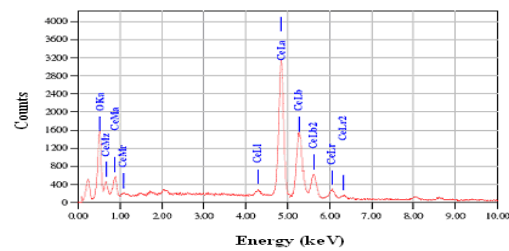

Fig. 2

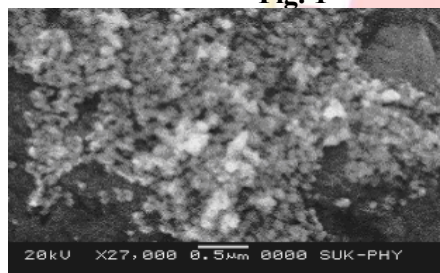

Fig. 3

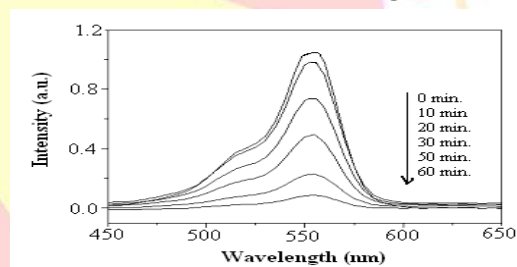

Fig.4

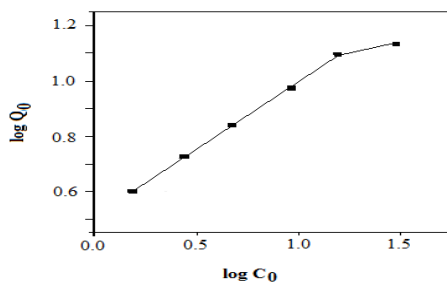

Fig.5

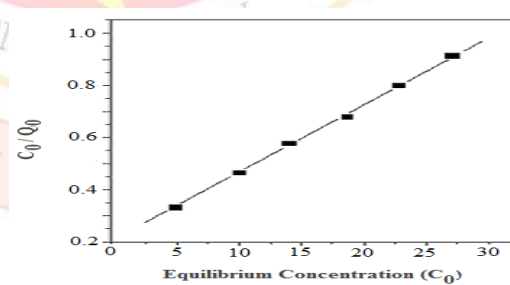

Fig.6

**Fauna Of Amphibia From Poladpur Tehsil, Western Ghats, Maharashtra, India.****B.P.Tingare**Dr.Babasaheb Ambedkar College,  
Mahad. Dist-Raigad (M.S) India.**Abstract**

We survey the selected spots of Poladpur tehsil of Raigad district of Western Ghats from June 2013 to 2014 during rainy season. Western Ghats of India is well known for biodiversity hotspots. The selected spots are well known biodiversity hot spots in Poladpur Tehsil of Raigad district of Western Ghats. The ecological parameters viz. Rain fall, temperature, humidity etc. are favorable for inhabitations of amphibians. We reported 13 species of amphibians belongs to 5 families 6 genera in Mangoan Tehsil of 342 species of amphibian found in India belongs to 15 families.

**Key Words:** Amphibian fauna, Poladpur tehsil Western Ghats, etc

**Introduction:-**

India has two well known as biodiversity hotspots amongst the 25 biodiversity hotspots of the world. Out of two, western Ghats is one of the well known for biodiversity hotspots in India. As far as Western biodiversity is concerned the southern part of the Western Ghats is more explored than the northern Western Ghats, Maharashtra. As far as Western part of Poladpur tehsil is concerned Karje, Umarath, Kapada, Poladpur and Kangori are well known biodiversity hotspots in Kokan region of Poladpur Tehsil. The survey of Indian amphibian fauna has been developed by many herpetologists such as Annandale, Broulanger Daniel, Pillai, Dutta etc. Sekar (1989) Ravichandran and Pillai (1990), Daniel (1992), Dutta (1992), Padhy et al (2000,2002) Frost et al (2006), Dinesh et al, (2011) and Jadhav et al (2007).

**Study Area:**

Poladpur Tehsil in Raigad district of Maharashtra lies between latitude 17° 55' and 18° 05' N and longitude 73° 50' and 74° 30' E. The famous Karje locate at latitude 17° 55' N and longitude 73° 05' E and 74° 05' E and Umarath and kapada situated at latitude 17° 20' N and longitude 73° 15' E. The Poladpur and kangori locate at latitude 17° 55' and 18° 01' N and longitude 73° 25' and 73° 30' E respectively. The selected spots cover with grassland, Semi evergreen forest and deciduous forest. Altitude of Kangori 754 m above the sea level and a average rainfall 3038 mm/year. Average temperature was 26°C. Biodiversity of frogs and caecilians were least known. Hence, the attempt has made on fauna of amphibian from Poladpur tehsil.

**Materials And Methods:**

The surveys were carried out during 2013-2014 in different selected spots of Poladpur Tehsil of Western Ghats, Maharashtra as a part to study of amphibian fauna. Survey were carried out mostly Karje, Umarath Poladpur and at fifteen day interval mostly during night in rainy season. We surveyed various habitats such as open land, dense forest, mixed forest and cultivated fields such as ground nut, Paddy and nachani. Studies diversity of amphibians especially Frogs, Toads, Caecilians particularly during night at ponds, Shallow streams, hilly waterfalls and moist places nearby rivers, booklets, Ponds Swamps and its nearly moist and shadow places. Only sample specimen of Unknown species carried out in laboratory for further identification.

During survey used the Nikon Camera for photographs of Frogs, Toads and Caecilians, Head torches for light, plastic bottle for collecting unknown sample specimen. After getting photographs frogs, toads and caecilians were released in their natural habitat.

**Results And Discussion:**

During this survey, we reported 13 species of amphibians belongs to 5 families and 6 genera in Poladpur Tehsil of Raigad district Western Ghats. Prasad and et al (2013) reported 37 species of amphibians belongs to 8 families 14 genera in Patan tehsil.

Chick List of Amphibian fauna of Poladpur Tehsil of Raigad District of western Ghats.

Sr.No	Amphibian Species
<b>01</b>	<b>A) Family: Ranidae Gray 1825</b>
<b>I</b>	<b>Genus :Rana Linnaeus 1758</b>
	1. <i>Rana tigerina</i> Daudin 1802
	2. <i>Rana hexcadactla</i> Lesson 1834
	3. <i>Rana beddomi</i>
	4. <i>Rana cyanophlyctis</i> Schneidr 1799
	5. <i>Rana nilgeri</i>
	6. <i>Rana temporalis</i> Gunter 1864
<b>02</b>	<b>B) Family Racophoridae Hoffman 1932</b>
<b>II</b>	Genus :Polypedates Tschudi 1838
	7. Polypedates maculates Gray 1864
<b>03</b>	<b>C) Family Bufonidae Gray 1825</b>
<b>III</b>	Genus :Bufo Laurenti 1768
	8. Bufo metanosticus Schneider 1799
	9. Bufo stomaticus Lutken 1862
<b>04</b>	<b>D) Family Microhylidae Gunter 1858</b>
<b>IV</b>	Genus Microhyla Tschudi 1838
	10. Microhyla ornate Dumeril & Bibron 1843
<b>V</b>	Genus: Uperodon Dumeril & Bibron 1843
	11. Uperodon Globulosus Gunter 1864
<b>05</b>	<b>E) Family: Ichthyophidae Taylor 1968</b>
<b>VI</b>	Genus :Ichthyophis Fitzinger 1826
	12. Ichthyopis bombayensis
	13. Ichthyopis Sp.

#### Acknowledgements:

The author is thankful to Suresh Athwale, Principal Dr. Babasaheb Ambedkar College Mahad for providing Infrastructural facilities .BPT is thankful to UGC ,Pune for providing financial support for minor research project.

#### References:

- Chanda, S.K.(2002) Hand book of Amphibians .Zoological survey of India.Kolkatta 1-350
- Daniel, J.C.(2002) The book of Indian Reptiles and Amphibians .Bom.Nat.Hist.Soc.1-238
- Dinesh K.P. C. Radhakrishnan, K.V.Gururaja, K Deuti and G.Bhatta (2011) A checklist of Amphibian of India .Online version .Zool.Survey India 1-11.
- Gururaja ,K.V(2011) Sahyadri Western Ghats Biodiversity Information system A Review list of Amphibian of the Western Ghats /wgbis.ces iisc ernet .in biodiversity /Sahyadri\_ enews /news.1-10
- Gururaja K.V. (2012) Pictorial guide to Frogs and Toads of Western Ghats .Gubbi Labs LLP. http // www.gubbilabs.in .1-153.
- Myers N. and et al (2000) Biodiversity hotspots for conservation priorities. Nature 403:853-858.
- Padhy A.D., Mahabaleshwarkar and H.V.Ghate (2002) An overview of Amphibian fauna of Pune district with special reference to their status Zoo print J.17 (4):757-763.
- Sekar A.G.(1999) Key of the Amphibian fauna of Goa .Herpeton 4:3-4

## A Comparative Analysis of Mathematical Linear Programming Problem

**Dr. Janardhan K. Mane**

Department of Mathematics Sanjeevane Mahavidyalaya,  
Chapoli, Dist. Latur. M.S

**Mahesh S. Wavare**

Head, Department of Mathematics, Rajarshi Shahu  
Mahavidyalaya (Autonomous), Latur. M.S

### Abstract:-

*In this paper Comparative Analysis of Linear Programming problems arise in different method of solving LPP such as Mathematical Formulation, Linear Programming Problem Graphical Method and LPP in Simplex Method. The Simplex Method is matrix based method used for solving linear programming problems with any number of variables. The Linear Programming Problem is a some special case of Mathematical Formulation. Depending on the objective we want to optimize Minimize or Maximize, we obtain the typical Linear programming Problem. Also introduce linear programming, one of the most powerful tools in operations research. Thus equipped, we then venture into some of the many applications that can be modeled with linear programming. This subsection will first demonstrate how to plot constraints, and then show how to deal with objective functions, and then put it all together in the graphical solution method. As with the graphical method, the simplex method finds the most attractive corner of the feasible region to solve the LP problem. Also some of the variations and some special cases in Linear Programming Problem and its Comparative Analysis have been discussed in the paper.*

**Keywords:-**Mathematical linear programming problem, Linear Programming Problem(LPP), Graphical Method of LPP, Simplex Method.

### Introduction

The Linear Programming Problem (LPP) of the Mathematical Programming consists of a linear objective function and a set of linear constraints to be fulfilled. It is simple in structure but powerful in applicability to a wide range of problems in engineering, medicine, agriculture, industry, business, social science, management, defense, administration, communication etc... It has become an important model in modern theoretical and applied mathematics and has proved to be one of the most effective tools in operations research for decision making. The success of it stems from its flexibility in depicting real world situations varying from military operations to behavioral and social sciences. It is a model to get the best out of a given situation. Linear Programming Problems are concerned with the optimal allocation of limited resources to meet certain desired objective. The linear function, which is to be optimized, is called the objective function and the conditions to be satisfied are expressed as simultaneous linear equalities or inequalities referred to as constraints. A solution vector, which satisfies the set of constraints and the given objective, is termed as an optimal solution. The logical analysis and conclusions of all decision making problems are based on the concept of models and model building, which is an abstraction of the reality and may appear to be less complex than the reality itself. The collection of data is the most difficult part of constructing a model. The formulation of a linear programming model involves a detailed study of the system, data collection, identification of decision variables, and construction of the objective function and system constraints. In the course of formulating a model, model builders often tend to include inadvertently or innocently, constraints and variables that may not play a role at all in defining the feasible set. The presence of such constraints / variables is hardly disputed and can play havoc with Linear Programming solution procedures and greatly hamper the solution effort. It is well known that every additional constraint / variable in a Linear Programming Problem demands more computational effort and computer memory. The identification of such embedded non-role play constraints / variables in the model without affecting the character of the system is as difficult as solving the Linear Programming Problem itself.

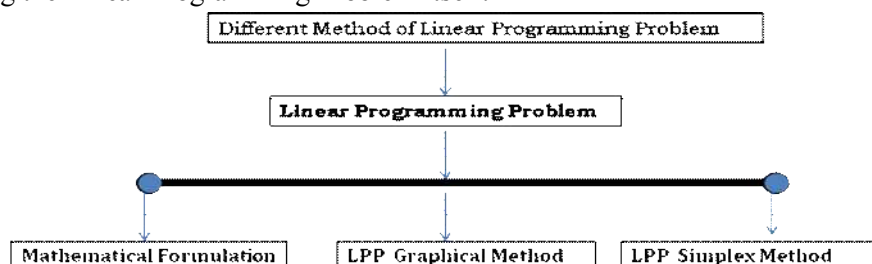

### Linear Programming Problem

Linear programming is a powerful quantitative technique (or operational research technique) designs to solve allocation problem. The term ‘linear programming’ consists of the two words ‘Linear’ and ‘Programming’. The word ‘Linear’ is used to describe the relationship between decision variables, which are directly proportional. For example, if doubling (or tripling) the production of a product will exactly double (or triple) the profit and required resources, then it is linear relationship. The word ‘programming’ means planning of activities in a manner that achieves some ‘optimal’ result with available resources. A program is ‘optimal’ if it maximizes or minimizes some measure or criterion of effectiveness such as profit, contribution (i.e. sales-variable cost), sales, and cost. Thus, ‘Linear Programming’ indicates the planning of decision variables, which are directly proportional, to achieve the ‘optimal’ result considering the limitations within which the problem is to be solved.

**Decision Variables:** - The decision variables refer to the economic or physical quantities, which are competing with one another for sharing the given limited resources. The relationship among these variables must be linear under linear programming. The numerical values of decision variables indicate the solution of the linear programming problem.

**Objective Function:** - The objective function of a linear programming problem is a linear function of the decision variable expressing the objective of the decision maker. For example, maximization of profit or contribution, minimization of cost/time.

**Constraints:** - The constraints indicate limitations on the resources, which are to be allocated among various decision variables. These resources may be production capacity, manpower, time, space or machinery. These must be capable of being expressed as linear equation (i.e. =) or inequalities (i.e. > or <; type) in terms of decision variables. Thus, constraints of a linear programming problem are linear equalities or inequalities arising out of practical limitations.

**Non-negativity Restriction:** - Non-negativity restriction indicates that all decision variables must take on values equal to or greater than zero.

**Divisibility:** - Divisibility means that the numerical values of the decision variables are continuous and not limited to integers. In other words, fractional values of the decision variables must be permissible in obtaining optimal solution.

**Certainty:** - In all LP models it is assumed that, all the model parameters such as availability of resources, profit contribution of a unit of decision variable and consumption of resources by a unit of decision variable must be known and constant.

### The General Lpp And Computational Procedures

The general linear programming problem as under: Subject Maximize (Minimize)

$$Z = C_1X_1 + C_2X_2 + \dots + C_nX_n$$

subject to conditions

$$a_{11}X_1 + a_{12}X_2 + \dots + a_{1n}X_n \leq b_1 \text{ (Maximum availability)}$$

$$a_{21}X_1 + a_{22}X_2 + \dots + a_{2n}X_n \geq b_2 \text{ (Minimum availability)}$$

$$a_{31}X_1 + a_{32}X_2 + \dots + a_{3n}X_n = b_3 \text{ (Equality)}$$

□

□

$$a_{m1}X_1 + a_{m2}X_2 + \dots + a_{mn}X_n \leq = \geq b_m$$

$$\text{And } x_1; x_2; \dots; x_n \geq 0 \text{ (Non-Negative restriction)}$$

### The Mathematical Formulation Of Lpp

The steps involved in the formation of linear programming problem are as follows:

- Step 1: Identify the Decision Variables of interest to the decision maker and express them as  $X_1, X_2, X_3 \dots$
- Step 2: Ascertain the Objective of the decision maker whether he wants to minimize or to maximize.
- Step 3: Ascertain the cost or the profit per unit of each of the decision variables.

Step 4: Ascertain the constraints representing the maximum availability or minimum commitment or equality and represent them as less than or equal to ( $\leq$ ) type inequality or 'equal to' ( $=$ ) type equality respectively.

### **Marketing Problem:**

The P Q stone company sells stone secured from any of the two adjacent quarries. The stone sold by the company must conform to the following specifications.

Material X equal to 40% and material Y equal to 30%.

Stone from quarry a cost Rs. 15 per tone and has the following properties.

Material X: 4%, Material Y: 2%

Stone from quarry B cost Rs. 20 per tone and has following properties

Material X: 2%, Material Y: 3%

### **Formulation Mathematical**

The data of the problem is summarized below

Material	Quarry		Specifications
	A	B	
X	4	2	40
Y	2	3	30
Cost per tone	15	20	

$$\text{Max } Z = 15x_1 + 24x_2 \text{ Subject to constraints}$$

$$4x_1 + 2x_2 \leq 40, 2x_1 + 3x_2 \leq 30 \text{ and } x_1, x_2 \geq 0$$

### **Linear Programming Problem In Graphical Method**

Graphical method of linear programming is used to solve problems by finding the highest or lowest point of intersection between the objective function line and the feasible region on a graph

**Closed Half Plane:** - A linear inequality in two variables is known as a half plane. The corresponding equality or the line is known as the boundary of the half plane. The half plane along with its boundary is called a closed half plane. Thus, a closed half plane is a linear inequality in two variables, which include the value of the variable for which equality is attained.

**Feasible Solution:** - Any non-negative solution which satisfies all the constraints is known as a feasible solution of the problem.

**Feasible Region:** - The collection of all feasible solutions is known as a feasible region.

**Convex Set:** - A set (or region) is convex if only if for any two points on the set, the line segment joining those points lies entirely in the set. Thus, the collection of feasible solutions in a linear programming problem forms a convex set. In other words, the feasible region of a linear programming problem is a convex set.

**Convex Polygon:** - A convex polygon is a convex set formed by the intersection of a finite number of closed half planes.

**Extreme Points or Vertexes or Corner Points:-** The extreme points of a convex polygon are the points of intersection of the lines bounding the feasible region. The value of the decision variables, which maximize or minimize the objective function, is located on one of the extreme points of the convex polygon. If the maximum or minimum value of a linear function defined over a convex polygon exists, then it must be on one of the extreme points.

**Redundant Constraint:** - Redundant constraint is a constraint, which does not affect the feasible region. Multiple Solutions Multiple solutions of a linear programming problem are solutions each of which maximize or minimize the objective function. Under graphical method, the existence of multiple solutions is indicated by a situation under which the objective function line coincides with one of the half planes generated by a constraint. In other words, where both the objective function line and one of constraint lines have the same slope.

**Unbounded Solution:** - An unbounded solution of a linear programming problem is a solution whose objective function is infinite. A linear programming problem is said to have unbounded solution if its solution can be made infinitely large without violating any of the constraints in the problem. Since there is no real applied problem, which has infinite returns, hence an unbounded solution always represents a problem that has been incorrectly formulated. For example, in a maximization problem at least one of the constraints must



be an equality' or 'less than or equal to' ( $\leq$ ) type, then there will be no upper limit on the feasible region. Similarly for minimization problem, at least one of constraints must be an 'equality' or 'a greater than or equal to' type ( $\geq$ ) if a solution is to be bounded. Under graphical method, the feasible solution region extends indefinitely.

**Infeasible Problem** A linear programming problem is said to be infeasible if there is no solution that satisfies all the constraints. It represents a state of inconsistency in the set of constraints.

### An Idea of linear programming

If the feasible set of a linear programming problem with two variables is bounded (contained inside some big circle; equivalently, there is no direction in which you can travel indefinitely while staying in the feasible set), then, whether the problem is a minimization or a maximization, there will be an optimum value. Furthermore:

- there will be some corner point of the feasible region that is an optimum
- if there is more than one optimum corner point then there will be exactly two of them, they will be adjacent, and any point in the line between them will also be optimum.

### Practical Steps Involved In Solving Lpp By Graphical Method

The practical steps involved in solving linear programming problems by Graphical Method are given below:

Step 1: Consider each inequality constraint as equation.

Step 2: Take one variable (say x) in a given equation equal to zero and find the value of other variable (say y) by solving that equation to get one co-ordinate [say (0, y)] for that equation.

Step 3: Take the second variable (say y) as zero in the said equation and find the value of first variable (say x) to get another co-ordinate [say (x, 0)] for that equation.

Step 4: Plot both the co-ordinates so obtained [i.e., (0, y) and (x, 0)] on the graph and join them by a straight line. This straight line shows that any point on that line satisfies the equality and any point below or above that line shows inequality. Shade the feasible region which may be either convex to the origin in case of less than type of inequality.

Step 5: Repeat Steps 2 to 4 for other constraints.

Step 6: Find the common shaded feasible region and mark the co-ordinates of its corner points.

Step 7: Put the co-ordinates of each of such vertex in the Objective Function. Choose that vertex which achieves the most optimal solution.

Table:-

Vertex No	Co-ordinates of vertices of common Shaded Feasible region	Value of Z
1	$(x_1, y_1)$	$Z_1 =$
2	$(x_2, y_2)$	$Z_2 =$
3	$(x_3, y_3)$	$Z_3 =$
4	$(x_4, y_4)$	$Z_4 =$

**Step:** Let  $x_1, x_2$  represent the proportion of stone in tone to be produced from quarries A and B

Objective function: The objective function is to minimize the total cost i. e.  $\text{Max } Z = 15x_1 + 20x_2$

Constraints: The constraints are on the two types material of the stone there are graphical method of solving LPP

$$\text{Max } Z = 15x_1 + 24x_2$$

subject to constraints

$$4x_1 + 2x_2 \leq 40, 2x_1 + 3x_2 \leq 30 \text{ and } x_1, x_2 \geq 0$$

Solution: Let us convert each both of the constraints from ' $\leq$ ' type to '=' type

$4x_1 + 2x_2 = 40, 2x_1 + 3x_2 = 30$  Now we draw corresponding lines for each equation as follows.

The first constraints  $4x_1 + 2x_2 = 40$

When  $x_1 = 0$  we get  $4 \times 0 + 2x_2 = 40$  implies  $x_2 = 20$

Similarly  $x_2 = 0$  we get  $2x_1 + 2 \times 0 = 30$  implies  $x_1 = 10$

The second constraints  $2x_1 + 3x_2 = 30$

When  $x_1 = 0$  we get  $2 \times 0 + 3x_2 = 30$  implies  $x_2 = 10$

Similarly  $x_2 = 0$  we get  $2x_1 + 3 \times 0 = 30$  implies  $x_1 = 15$

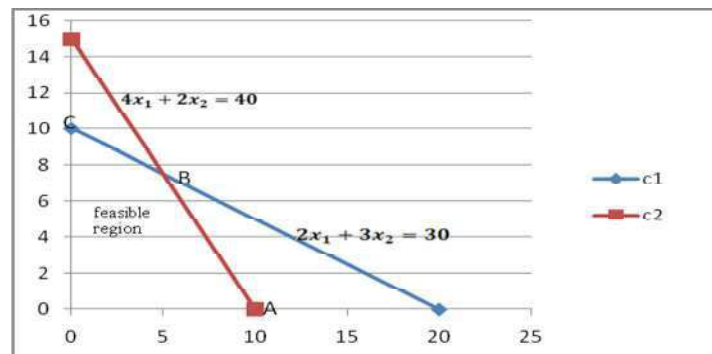

Point	$x_1$	$x_2$	$z = 15x_1 + 2x_2$
O	0	0	0
A	10	0	150
B	7	5	205 Maximize
C	0	10	200

### Simplex Method

It was developed by G. Danztig in 1947. The simplex method provides an algorithm which is based on the fundamental theorem of linear programming. If the feasible region to any linear programming problem has at least one point and is convex and if the objective function has a maximum (or minimum) value within the feasible region, then the maximum (or minimum) will always occur at a corner point in that region. Criteria for the existence of solutions,  $f(x,y) = ax + by$  If the feasible region is bounded, then has a maximum and minimum. If the feasible region is unbounded and  $a, b > 0$ , then  $f$  has a minimum; but not a maximum. The Simplex Method is “a systematic procedure for generating and testing candidate vertex solutions to a linear program.” (Gill, Murray, and Wright, p. 337) It begins at an arbitrary corner of the solution set. At each iteration the Simplex Method selects the variable that will produce the largest change towards the minimum (or maximum) solution. That variable replaces one of its compatriots that is most severely restricting it, thus moving the Simplex Method to a different corner of the solution set and closer to the final solution. In addition, the Simplex Method can determine if no solution actually exists.

The Simplex Method solves a linear program of the form described in Figure. Here, the coefficients  $C_j$  represent the respective weights, or costs, of the variables  $X_j$ . The minimized statement is similarly called the cost of the solution. The coefficients of the system of equations are represented by,  $a_{ij}$  and any constant values in the system of equations are combined on the right-hand side of the inequality in the variables  $b_i$ . Combined, these statements represent a linear program, to which we seek a solution of minimum cost.

Optimal Solution	Type of Problem	Optimum Solution
a)	In case of maximization problem	Maximum value of Z is the optimal solution
b)	In case of minimization problem	Minimum value of Z is the optimal solution

The following important definitions are necessary for understanding and developing the theory those fellows.

**Objective Function:** - The function that is either being minimized or maximized. For example, it may represent the cost that you are trying to minimize.

**Optimal Solution:-** A vector  $x$ , which is both feasible (satisfying the constraints) and optimal (obtaining the largest or smallest objective value).

**Constraints:-** A set of equalities and inequalities that the feasible solution must satisfy.

**Feasible Solution:-** A solution vector,  $x$ , which satisfies the constraints.

**Basic Solution:** - It is a solution obtained by setting any ‘n’ variable equal to zero and solving remaining ‘m’ variables such ‘m’ variables are called Basic variables and ‘n’ variables are called Non-basic variables.

**Slack Variable** A variable added to the problem to eliminate less-than constraints.

**Surplus Variable** A variable added to the problem to eliminate greater-than constraints.

**Artificial Variable** A variable added to a linear program in phase 1 to aid finding a feasible solution.

**Unbounded Solution** For some linear programs it is possible to make the objective arbitrarily small (without bound). Such an LP is said to have an unbounded solution.

**Computational Procedure Of Simplex Method**

The optimal solution to a General LPP is obtained in the following major steps:

Step 1 - Write the given GLPP in the form of SLPP

Step 2 - Present the constraints in the matrix form

Step 3 - Construct the starting simplex table using the notations.

Step 4 - Calculation of Z and  $\Delta_j$  and test the basic feasible solution for optimality by the rules

given.  $Z = C_B X_B$ . Procedure to test the basic feasible solution for optimality by the rules given.

- If all  $\Delta_j \geq 0$ , the solution under the test will be optimal. Alternate optimal solution will exist if any non-basic  $\Delta_j$  is also zero.
- If at least one  $\Delta_j$  is negative, the solution is not optimal and then proceeds to improve the solution in the next step.
- If corresponding to any negative  $\Delta_j$  all elements of the column  $X_{-j}$  are negative or zero, then the solution under test will be unbounded. In this problem it is observed that  $\Delta_1$  and  $\Delta_2$  are negative. Hence proceed to improve this solution

Step 5 – To improve the basic feasible solution, the vector entering the basis matrix and the vector to be removed from the basis matrix are determined.

**Incoming vector:** - The incoming vector  $X_{-j}$  is always selected corresponding to the most negative value of  $\Delta_{-j}$ . It is indicated by ( $\uparrow$ ).

**Outgoing vector:** - The outgoing vector is selected corresponding to the least positive value of minimum ratio. It is indicated by ( $\rightarrow$ ).

Step 6–Mark the key element or pivot element by ‘1’ the element at the intersection of outgoing vector and incoming vector is the pivot element.

- If the number in the marked position is other than unity, divide all the elements of that row by the key element.
- Then subtract appropriate multiples of this new row from the remaining rows, so as to obtain zeroes in the remaining position of the column  $X_{-j}$ .

Step 6– Now repeat step 4 through step 6 unit an optimal solution is obtained.

**Examples:** - Using simplex method to solve the following LPP

Max:  $Z = 15x_1 + 20x_2 + 0x_3 + 0x_4$  Subject to constraints

$$4x_1 + 2x_2 + x_3 = 40, 2x_1 + 3x_2 + x_4 = 30$$

Preset the constraints in the matrix form

$$\begin{bmatrix} 4 & 2 & 1 & 0 \\ 2 & 3 & 0 & 1 \end{bmatrix} \begin{bmatrix} x_1 \\ x_2 \\ x_3 \\ x_4 \end{bmatrix} = \begin{bmatrix} 40 \\ 30 \end{bmatrix}$$

**Simplex table**

**First Iteration Table**

Basic Variables		$x_3$	15	20	0	0	min ratio
	$x_3$	$x_4$	$x_1$	$x_2$	$x_3$	$x_4$	

$x_1$	0	40	4	2	1	0	$40/2 = 20$
$x_2$	0	30	2	$[\frac{3}{2}]$	0	1	$30/3 = 10$
	$Z =$	$x_1 = 40$	-15	-20	0	0	

$$Z = [0 \ 0] \begin{bmatrix} 40 \\ 30 \end{bmatrix} = 0$$

$$\Delta_j = C_j - Z_j = C_j - C_1x_1 - C_2x_2$$

**Second Iteration Table**

Basic Variables		$x_1$	15	20	0	0	min ratio
	$x_1$	$x_1$	$x_1$	$x_2$	$x_1$	$x_2$	
$x_1$	0	20	-5/3	0	1	-7/3	
$x_2$	20	10	3	1	0	1/3	
	$Z =$	$x_1 = 200$	45	0	0	0	

$$Z = [0 \ 20] \begin{bmatrix} 20 \\ 10 \end{bmatrix} = 20*10 = 200$$

$$\Delta_j = C_j - Z_j = C_j - C_1x_1 - C_2x_2$$

Therefore solution is max Z=200

**Conclusion**

We study Linear Programming problems arise in different method of solving LPP such as Mathematical Formulation, Linear Programming Problem Graphical Method and LPP in Simplex Method. Also in this paper presents a insight into understanding, analyzing a linear programming problem and obtaining a optimum solution (maximization or minimization) by simplex method. The procedure and algorithm of simplex method with examples are discussed in detail to understand the LPP more precisely and effectively. Give a Marketing problem in a data center, and an application of Linear Programming problems are a well studied topic in combinatorial optimization. These problems find numerous applications in production planning, engineering, medicine, agriculture, industry, business, social science, management etc.

**References**

1. Dr. B S Grewal , Higher Engineering Mathematics, Khanna Publishers
2. Dr. V. H. Bajaj, Dr. Hemant. P. Umap, Dr. Omprakash. S. Jadhav, Operation Reasearch, Statperson publishing Corporation.
3. Winston, Wayne L. Operations Research: Applications and Algorithms, 2nd ed., Boston: PWS-Kent, 1991.
4. Hillier, Frederick S., and Gerald J. Leberman. Introduction to Operations Research, 4th ed., Oakland, Calif.: HoldenDay, 1986.
5. A. Schrijver, Theory of linear and integer programming. John Wiley& Sons, 1986.
6. Dr. K S Chandrashekar , Engineering Mathematics, Sudha Publications
7. Prof G K Ranganath , Introduction to Linear Programming , S Chand & Company
8. www.studymode.com/essays/linearprogramming.

## A Comparative Study Between Chemical And Biocatalytic Reduction Of Prochiral Ketones

Prabha R. Salokhe

Department of chemistry, Y. C. Warana Mahavidyalaya, Warananagar

### Abstract:

*The demand for optically pure synthetic intermediates and the drive to adopt green methods of synthesis have stimulated a growing interest in biocatalysis as a selective and environmentally benign synthetic technique. With the aim of designing a fully sustainable and ecofriendly procedure for reduction of prochiral ketones, we have focused attention to carry out comparative study of reduction using conventional chemical as well as biocatalytic methods for benzophenone, propiophenone and its analogues. The influencing parameters and absolute results of the analysis gives the result of superiority of use of biocatalysts in reduction of prochiral ketones.*

**Key words :** chemical catalyst, biocatalyst, reduction, prochiral ketones.

### Introduction

The growing awareness of the need for green, clean and more sustainable technologies has focused attention on the use of atom efficient different catalytic methodologies for the manufacture of fine chemicals, agrochemicals and pharmaceuticals. The use of nonconventional reaction media also provides opportunities for facilitating the recovery and recycling of the catalyst<sup>1</sup>. The use of alternative biocatalyst that circumvent the problems associated with many of the traditional chemical catalysts is one more aspect which is receiving more attention from the view point of green chemistry. The present processes for synthesizing chemical products are highly inefficient. The E factor<sup>2</sup> provided a quantifiable measure of such inefficiency and showed that, for every kilogram of fine chemical and pharmaceutical products produced, 10 –100 times that amount of chemical waste is generated. Such low efficiency in state of the art organic synthesis presents great challenges in resource conservation and draws environmental and health problems related to the chemical wastes. To address these challenges, innovative and fundamentally novel catalysts is needed throughout the synthetic processes.

The reduction of prochiral ketones generally yielded secondary alcohols. The scope of reducing agents used in conventional chemical reduction has been greatly expanded from the use of hydrogen gas in catalytic hydrogenation, the use of non gaseous reducing agents like sodium borohydride, lithium aluminium hydride, alkoxy aluminum hydride and boranes. However these reactions usually lacks specificity and gives racemic mixture. Initial efforts toward enantioselective ketone reductions focused on the development of chiral, non-racemic reducing agents and opens a new era of asymmetric synthesis. Chiral metal catalysts such as oxazaborolidinium ion (COBI)<sup>3</sup> enables a highly enantioselective hydrosilylation of ketones for the synthesis of various chiral secondary alcohols in good yields and excellent enantioselectivities,. An asymmetric transfer hydrogenation of diaryl ketones is promoted by bifunctional Ru complexes with an etherial linkage between 1,2-diphenylethylenediamine (DPEN) and  $\eta^6$ -arene ligands<sup>4</sup> have been successfully used as chemical catalyst for synthesizing chiral alcohols. However trace metal contamination left in the products and the high cost of catalysts are unresolved difficulties affecting many reactions . To overcome the issues of traditional metallo and organo-catalysis and with the aim of designing a fully sustainable and ecofriendly procedures, we have focused attention to carry out reduction reactions using green methodologies. Biocatalysis has many attractive features in the context of green chemistry e.g. these processes are environment friendly in contrast to conventional chemical catalytic processes. They accelerates the rate of reaction in the order of  $10^9$  to  $10^{12}$  under mild condition. Also, They shows a high degree of enantio- differentiation in their catalytic activity. This affords processes which are shorter, generate less waste and are therefore, both environmentally and economically more attractive than conventional catalytic methods.

The present study describes in detail procedure and experimental results for chemical as well as biocatalytic reduction of prochiral ketones like benzophenone, propiophenone and its analogues and has made a comparison of experimental results.

For biocatalytic reduction herein, we report enantioselective bioreduction of prochiral ketones using the fungus *Rhizopus arrhizus* to obtain the corresponding (S)-aryl alcohols

## Experimental Section

**Chemical synthesis of substrates:** The reducing agent  $\text{NaBH}_4$  and the substrate propiophenone and benzophenone was obtained from Lancaster while p-chloro propiophenone, p-methyl propiophenone and p-methoxy propiophenone have been synthesized by using chlorobenzene, toluene and anisole with polyphosphoric acid (PPA) - propionic acid and benzoic acid by using conventional as well as microwave methods<sup>5</sup>. The metabolites were purified and characterized by IR, NMR.

**Cultures and analytical methods:** The *Rhizopus* species, *R. arrhizus* NCIM 1009, was obtained from the National Collection of Industrial Microorganisms, National Chemical Laboratory Pune, India.

IR spectra were recorded on Perkin-Elmer FTIR spectrometer. The NMR spectra were recorded in  $\text{CDCl}_3$  with TMS internal reference standard on varian-Gemini 200 NMR spectrometer. Optical rotations were measured on Jasco digital polarimeter.

**Chemical reduction of substrates :** To a stirred solution of propiophenone (1 mmol) in methanol (10 ml), sodium borohydride (2 mmol) was added in portions at  $0^\circ\text{C}$ . After the addition was complete (30 min) the stirring was continued at R.T. and the progress of the reaction was monitored by TLC. After the completion of reaction, methanol was removed under reduced pressure, followed by addition of saturated solution of ammonium chloride (20 ml) and extracted with ether (3 X 10 ml). The ether layer was washed with brine and dried over anhydrous sodium sulphate, (2 g). Removal of the solvent gave corresponding ( $\pm$ ) 1-(4-methoxy-phenyl)-propan-1-ol in quantitative yield. The product was purified by column chromatography and characterized by IR, NMR data and correlates with the literature value.

**Biocatalytic reduction of substrates :** *Rhizopus arrhizus* inoculated in autoclaved (15 psi for 20 min) 500 mL cotton plugged conical flask containing 150 mL of Czapek-dox medium. The substrates 1(a-e) (100 mg each in 1 mL of 95 % ethanol) were added to 72 h grown culture and incubated on rotary shaker for different time intervals. At the end of biotransformation, the mycelial mass was filtered from the culture medium. The filtrate was extracted with chloroform, washed with water and dried over anhydrous  $\text{Na}_2\text{SO}_4$ . The transformed products were purified by preparative TLC (silica gel GF-254) and characterized by IR,  $^1\text{H}$  NMR spectroscopy and optical rotations.

## Results and Discussion

The chemical reduction of propiophenone, its p-chloro, p-methyl, p-methoxy derivatives and benzophenone 1 (a-e) using  $\text{NaBH}_4$  yielded corresponding **racemic** alcohols. 2(a-e). While the biocatalytic reduction of the same substrates with *Rhizopus arrhizus* gives corresponding (**S**) alcohols. 3(a-e). (**Scheme D**)

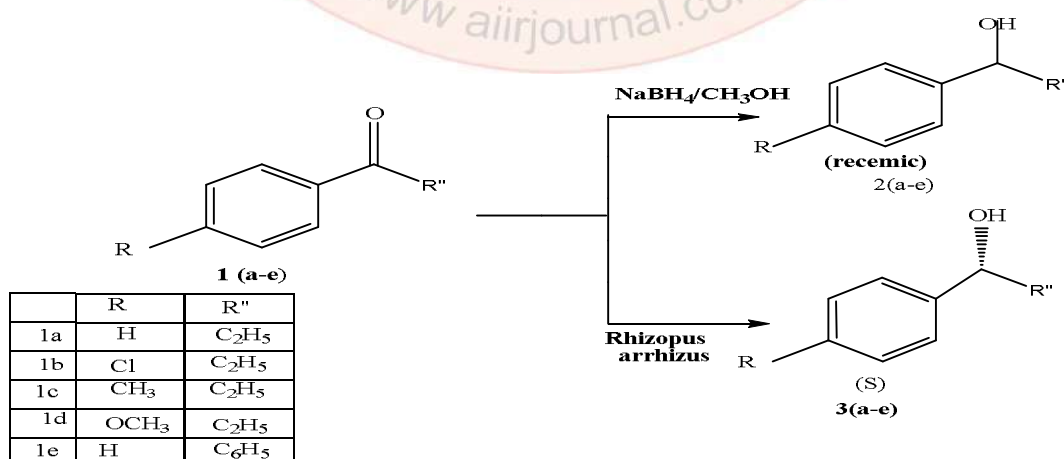

Scheme I

Among different reducing agents, sodium borohydride is more specific for the reduction of aldehydes and ketones. It is also selective between carbonyl groups in different environment and bring

reduction of carbonyl group to **recemic alcohols**. However, when we use *Rhizopus arrhizus* as biocatalyst, due to their high enantio, regio, and stereoselective properties **chiral alcohols** are obtained.

The comparative study of yield obtained in both the reduction methods is summarized in the ( **Table 1** )

**Table 1 : Reduction of substrates 1(a-e) by chemical and biocatalytic method**

substrate	Chemical method		Biocatalytic method			
	Product (racemic)	Yield(%)	Product (chiral)	Yield (%)	ee(%)	configuration
<b>1a</b>	2a	70	3a	70	80	(S)
<b>1b</b>	2b	64	3b	72	83	(S)
<b>1c</b>	2c	75	3c	75	85	(S)
<b>1d</b>	2d	50	3d	60	45	(S)
<b>1e</b>	2e	72	3e	80	90	(S)

It is observed that the yield of recemic alcohol obtained by chemical method is comparatively less than the biocatalytic method. Also the biocatalytic reactions are generally safe with mild reaction conditions; the solvent is usually water and hazardous reagents are not necessary. As these are natural catalysts, they decompose easily in the environment. On the contrary, reduction by conventional method requires hazardous chemical reagents, solvents and reaction conditions. Even for selective catalysis, more selective and expensive catalyst composition is required. Thus, the simplicity, stereospecificity and high efficiency of the biocatalytic processes make them an attractive alternative to the existing methods in asymmetric catalysis for obtaining highly functionalised chiral alcohols in enantiomerically pure forms.

### Conclusion

In conclusion, the comparative study for the reduction of prochiral ketones by chemical as well as biocatalytic methods shows that biocatalytic reduction using *R. arrhizus* NCIM 1009, provides an inexpensive, operationally simple method for asymmetric reduction of benzophenone, propiophenone and its analogues. This process is more efficient and generates less waste than the conventional chemical reagents.

### References

1. R. A. Sheldon, Critical review Green Chemistry, (2005). DOI: 10.1039/b418069k
2. Sheldon RA (1994) ChemTech 38–47.
3. B. C. Kang, S. H. Shin, J. Yun, D. H. Ryu, *Org. Lett.*, **2017**, *19*, 6316-6319.
4. T. Touge, H. Nara, M. Fujiwhara, Y. Kayaki, T. Ikariya, *J. Am. Chem. Soc.*, **2016**, *138*, 10084-10087.
5. D.A. Learmonth, *Synth. Commun.*, **32**, 2757 (2002).

**Tobacco induced alteration in the Mantle of terrestrial molluscs *Leveculusalte*****R.R. Patil A.C. Jadhav J.G. Mangule, S. S. Shaikh, S.R. Patil, A.A. Jog and N.H. Shaikh**

Department of Zoology, D.K.A.S.C. college, Ichalkaranji.

**Abstract**

In the present day we facing problems related with the use of Tobacco. So present study desgined to investigate the effect of Tobacco on the respiratory system. From the findings, we concluded that, Slug *L. alte* giving response to Induction of Tobacco and alter their normal structure of mantle. The major alterations includes, hypertrophy decreased number of epidermal cells, increased blood space, shrinkage in connective and muscular tissues with depleted number of leydig cells. So this study brief information about the effect of Tobacco on the respiratory system of experimental animals.

**Introduction**

In the last decades the world facing problem related with the use of Tobacco and tobacco related product. Organization pointed out that, among the eight main causes of death in the world today, six are associated with tobacco exposure, among them we stress inflammatory and infectious diseases of the respiratory tract (Organizaç o Mundial da Sa de, 2008). *Nicotianatabacum L.*, of the Solanaceae family (figure 1), is an annual (sometimes bi- or triennial) herbaceous plant, that grows 1-3 metres high. It is native to tropical America, although it has since been farmed in many other areas (*angustifolia*, *brasilensis*, *fruticosa*, *havanensis*, *latissima*, *macrophylla*, *virginica*, etc.) (Lovell 1993). The best characterised chemicals found in tobacco and tobacco smoke include polycyclic aromatic hydrocarbons (PHs), such as benzopyrene, and the highly addictive alkaloid, nicotine and its metabolites. Nicotine, working through the neuronal nicotinic acetylcholine receptors in the brain, is responsible for the addictive nature of tobacco use; the alkaloid has also been implicated in conditions such as delayed wound healing and reproductive disorders (Mishra et al. 2015). Tobacco and tobacco smoke are strongly associated with various skin conditions, among which contact dermatitis is of prime importance. The aetiological and clinical aspects vary according to the different tobacco production and processing steps. Contact dermatitis is frequent in tobacco harvesters, curers and cigar makers, whereas it rarely affects smokers and, only exceptionally, cigarette packaging workers. The skin sites involved also vary, according to whether the exposure is occupational or non-occupational (Bonamonte et al. 2016).

Mollusca is the second largest phylum of invertebrate animals. The members are known as molluscs. Molluscs are the largest marine phylum, comprising 23% of all the named marine organisms. Numerous molluscs also live in freshwater and terrestrial habitats. Along with other terrestrial fauna, invertebrate molluscs are recognized as important animals principally involved in food chain and agricultural pests. Terrestrial gastropods are sensitive to toxic chemicals producing alterations at the cellular level (Hernadi et al. 1992; Boer et al. 1995). Angulo, and Saez (1986) reported depleted feeding and growth responses following exposure to Cu, Zn, Hg, and Pb toxicity in the terrestrial gastropod *Arion ater* (Linn). In recent decades Londhe and Kamble studied the effect of different heavy metals on different aspects of slug *Semperulamaculata* (Kamble and Londhe 2012a; 2012b; 2012c).

Easily availability of molluscan in the environment and the previous finding suggest molluscs are the useful species to find out effect of any relevant exposure. So the present study desgined to investigate the mortality response and alteration in the structural architecture of mantle of terrestrial slug *L. alte* against the tobacco at different exposure period.

**Materials and Methods****Animal for experiment:**

Adult herbivorous, hermaphrodite, terrestrial slugs *L. alte* were collected from natural habitats of Panmala at Arug and Bedug, Miraj, district Sangli, Maharashtra, India. Animals were carried in aerated plastic bottles to the lab. Experimental animals were kept in open-air trough covered with aerated plastic lead covering to provide proper ventilation. Experimental animals were allowed to feed on fresh leaves of mulberry plant (*Morus indica*). All the animals were kept under controlled lab conditions of water, temperature, and fresh air for better acclimatization



## Mortality Study

In the present investigation, effect of Tobacco on slug, were assessed by calculating its lethal concentration-

### I. Terrestrial slug *S. maculata*

#### a) Preparation of stock solution and doses

Water miscible tobacco powder were used as intoxication for present investigation. Initially the concentrations of these tobacco powder as 20, 40, 60, 80 and 100 gmtobacco Powder were completely dissolved in 1000 ml (1 lit) of double distilled waterrespectivilyr. The completely dissolved solution's were considered as a stock solution for respective concentration.

For the intoxication study, healthy 50 animals (slugs) (6-7 cm length, 1- 1.5 cm width and 3- 4 g weight) were used. 50 animals were divided into 5 sets (10 animals per set) as control group, set-I (intoxicated up to 24 hr), set-II (intoxicated up to 48 hr), set-III (intoxicated up to 72 hr) and set- IV (intoxicated up to 96 hr).

For each of the set, 1000 g of oven dried and then moistened soil filled in plastic trough was used. The 100 g of clean, fresh leaves of *Morusindica* (common name mulberry) were provided as a feed of animal. All troughs were covered with lid to prevention of escape of experimental animals as well as for complete induction of toxicant. To avoid confusion all the experimental sets (control, I, II, III and IV) were neatly labeled for perfect run up. For the intoxication, 150 ml prepared stock solution of tobaccowas daily sprinkled over oven dried moistened soil and experimental animals and were exposed upto 24 hr, 48 hr, 72 hr and 96 hr respectively. After completion of the intoxication period (24 hr, 48 hr, 72 hr and 96 hr) of respective metals, mortality in the animals was calculated after 24 hr of interval. For comparison control group was sprinkled by water only with mulberry leaves as food. Experiments were repeated thrice

#### Statistical analysis

Lethal concentration (LC<sub>50</sub>) for slug *L. alteat* 24, 48, 72 and 96 hr was calculated by Probit analysis method (Finney, 1997).

### Result and Discussion

#### Percent mortality in Slug *L. alte*

*L. alte*when exposed to 20000, 40000, 60000, 80000 and 10000 ppm concentration of tobacco,percent mortality was recorded every after 24 hr of interval upto 96 hrs of exposure period, mortality percent at 20000 ppm, after 24 hr of exposure showed 18% mortality, while 56% at 96 hrs of exposure. 40000 ppm concentration of tobacco showed increased rate of mortality at 24 hrof exposure i.e. 40%, where as 67 % at 96 hr. At 60000 ppm concentration, 61% mortality was recorded at 72 hr, whereas 45% and 74 % at 24 hr and 96 hr of exposure period respectively. At 80000 ppm 63% mortality of *L. alte*was observed after 72 hr and 66 % at 48 hr of exposure. 86% mortality was recorded after 96 hrs of exposure. 100% mortality was not found to above concentrations. 100000 ppm concentration showed, 65% mortality at 24 hr of exposure, while 96% mortality was observed at 96 hrs of exposure period. 76 % and 84% were recorded at 48 and 72 hr of exposure period respectively The detailed mortality percentage and LC<sub>50</sub> value were showed in Table – 1,2,3. Our result supported by other studies which done on the heavy metals effect Ramakritinan et al. (2012) observed higher rate of mortality in molluscs against less concentration of Cu and Cd and suggested that, it may be due impact of metal and individual sensitivity within the animal and its own health status.

Percent Mortality of slug <i>L. alte</i> against Tobacco				
Con. in ppm	24 hr	48 hr	72 hr	96 hr
Control	00	00	00	00
20,000	18	25	40	56
40,000	33	40	48	67
60,000	45	53	61	74
80,000	58	62	63	86
1, 00,000	65	68	84	96

**Table –1** Percent mortality of *L. altea* against tobacco induction.

24 hr						48 hr					
Conc. in ppm	Mortality %	Probit (Y)	Lnx	Lnx <sup>2</sup>	Lnx <sub>y</sub>	Conc. in ppm	Mortality %	Probit (Y)	Lnx	Lnx <sup>2</sup>	Lnx <sub>y</sub>
20000	18	4.08	4.3010	18.4986	6.5435	20000	25	4.3010	4.3010	18.4986	18,623
40000	33	4.56	4.6020	21.1784	8.4059	40000	40	4.6020	4.6020	21.1784	21,853
60000	45	4.87	4.7781	22.8302	9.3052	60000	55	4.7781	4.7781	22.8302	24,272
80000	58	5.20	4.9030	24.0394	25.9956	80000	62	4.9030	4.9030	24.0394	26,034
100000	65	5.30	5.0000	25.0000	26.5000	100000	68	5.3853	5.0000	25.0000	27,350
ΣY = 24,01		ΣLnx =14,6811		Σ Lnx <sup>2</sup> =111,54		ΣY= 24,9400		ΣLnx = 14,6811		Σ Lnx <sup>2</sup> = 111,54	
Ȳ = 4.802		Lnx = 2.9362		Σ Lnx <sub>y</sub> = 113,789		Ȳ = 4. 988		Lnx = 2.,9326		Σ Lnx <sub>y</sub> = 118,13	
72 hr						96 hr					
Conc. in ppm	Mortality %	Probit (Y)	Lnx	Lnx <sup>2</sup>	Lnx <sub>y</sub>	Conc. in ppm	Mortality %	Probit (Y)	Lnx	Lnx <sup>2</sup>	Lnx <sub>y</sub>
20000	40	4.75	4.3010	18.4986	20,429	20000	56	5.15	4.3010	18.4986	22,150
40000	48	4.95	4.6020	21.1784	22,779	40000	67	5.44	4.6020	21.1784	25,034
60000	61	5.28	4.7781	22.8302	25,228	60000	74	5,64	4.7781	22.8302	26,948
80000	63	5.31	4.9030	24.0394	26,034	80000	86	6,05	4.9030	24.0394	29,810
100000	84	5.99	5.0000	25.0000	29,950	100000	96	6,75	5.0000	25.0000	33,75
ΣY = 26,28		ΣLnx = 14,68		Σ Lnx <sup>2</sup> =111,54		ΣY = 29,06		ΣLnx = 14,6811		Σ Lnx <sup>2</sup> =111,54	
Ȳ = 5.256		Lnx =2.9362		Σ Lnx <sub>y</sub> = 124,42		Ȳ =5.812		Lnx = 2.9362		Σ Lnx <sub>y</sub> = 137,692	

**Table – 2** Observed numerical data for the evaluation of a and b associated with mortality caused due to intoxication of tobacco.

Exposure Period in hr	LC <sub>50</sub> Values of <i>L. altea</i> exposed to Tobacco (ppm)		Mean LC <sub>50</sub> in ppm
	Observed	Calculated	
24	78,000	78,610	45,747
48	52,000	51,530	
72	40,000	42,180	
96	12,000	10,607	

**Table - 3** LC<sub>50</sub> values of Tobacco in *L. altea* per exposure period.

**Histological alteration in Mantle after induction of Tobacco**

Respiratory system i.e.Mantle as a vital part in the anatomy of terrestrial slug *L. altea*, found dorsally covered by visceral mass. Usually has dark blackish color dorsally, and some what yellow whitish ventrally. Histologically, mantle composed of outer most epidermal layer with thin cuticle. Epidermis followed by connective tissue, muscle fiber, blood spaces, nerve fiber and fibroblast cells or leydig cells (Fig- A). Similar observation noted by Londhe and Kamble (2014) in the terrestrial slug *S. maculata*. For histological analysis experimental animals were intoxicated with mean LC<sub>50</sub> concentration of Tobacco-

Histology of mantle get altered due to intoxication of Tobacco After 24 hr, epidermal cell were disturbed/displaced from epithelial lining with increased blood space (Fig-B). After 48 hr, epithelial lining was damaged with dilated nuclei. Dilation of leydigs cells were found (Fig-C). Nuclear hypertrophy was intensively observed after 72 hr of exposure. The shape of epithelial cells and leydigs cells were minimized (Fig-D). After 96 hr of exposure, blood space was increased. Prominent damage in epithelial lining was seen. Muscular layer was heavily contracted, connective tissue was degenerated (Fig-E). The major alterations includes, hypertrophy decreased number of epidermal cells, increased blood space, shrinkage in connective

and muscular tissues with depleted number of leydigs cells. Choi et al. (2003), documented histological changes in mantle , gill, hepatopancreas, gonad and kidney of Antarctic bivalve *Laternula elliptica* due to cadmium induction. In terrestrial slug, skin play important role in controlling voluminous secretions containing water, ions, mucus, glycoprotein's, lectins and variety of other constituents elicited by mechanical and chemical stimulation (Martin and Olsen, 1985).

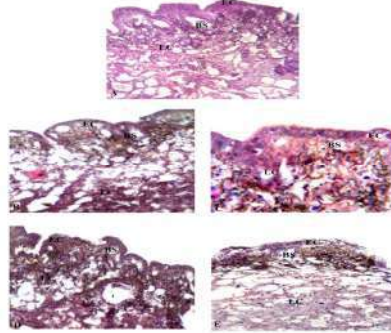

**Figure A** - Tobacco treated alteration in mantle of *L. alate* at 24 hr, 48 hr, 72 hr and 96 hr of exposure. Figure A- E Control and altered structure of mantle at different exposure period. HE 400X. Figure A- Control group 400X, Figure B-24 hr 400X, Figure C - 48 hr 400X, Figure D - 72 hr 400X, Figure E - 96 hr 400X, EC-epithelial cells, BS-blood space, LC – leydig's cells).

### Conclusion

From the findings of present study, we concluded that, Slug *L. alate* giving response to Induction of Tobacco and alter their normal structure of mantle. Which is important for respiration. So this study brief information about the effect of Tobacco on the respiratory system of experimental animals. From our finds we suggest the acute and chronic exposure with tobacco hamper the structures and function of animals i.e. is human beings.

### Acknowledgments

The authors are thankful to the Principal and Head, Department of Zoology, D.K.A.S.C. college Ichalkaranji for providing facilities in the progress of work.

### References

- Dotterud LK, Smith-Sivertsen T. 2007. Allergic contact sensitization in the general adult population: a population-based study from Northern Norway. *Contact Dermatitis*; 56: 10-5.
- Thyssen JP, Linneberg A, Menné T, Nielsen NH, Johansen JD. 2009. The effect of tobacco smoking and alcohol consumption on the prevalence of self-reported hand eczema; a cross-sectional population-based study. *Br J Dermatol*; 162: 619-26.
- Lovell CR. 1993. *Plants and the skin*. Oxford, United Kingdom: Blackwell Scientific Publications, 193-4.
- Martin AW, Deyrup-Olsen I (1986). Function of the epithelial channel cells of the body wall of a terrestrial slug, *Ariolimax columbianus*. *J Exp Biol*. 121: 301-314.
- Mishra A, Chaturvedi P, Datta S, Sinukumar S, Joshi P, Garg A. 2015. Harmful effects of nicotine. *Indian J Med Paediatr Oncol*; 36: 24-31.
- Kamble, N.A., and S.R. Londhe. 2012a. "Mercuric Chloride Induced Neuropathology and Physiological Responses in Slug *Semperulamaculata*." *International Journal of Zoological Research* 8: 33-42.
- Kamble, N.A., and S.R. Londhe. 2012b. "Epileptic Activity in Neuronal Cells, Induced by Mercuric Chloride and Cadmium Chloride in Terrestrial Slug *Semperulamaculata*: Fine Structure Investigated by Histology and Histochemistry." *Toxicological and Environmental Chemistry* 94: 109-120.
- Kamble, N.A., and S.R. Londhe. 2012c. "Neurochemistry in Molluscan Species: Focus on Extracellular Matrix." *Invertebrate Neuroscience* 12: 129-138.
- Organização Mundial da Saúde, 2008 <http://www.who.int/tobacco/mpower/en/acessadoem> 11 de julho de 2009.

**Ethics in Scientific Research****Dr. D. N. Bhosale, Dr. S. J. Lade**

Dept. of Physics, Y.C. Warana Mahavidyalaya, Warananagar -416113 (M.S.) INDIA

**Abstract :-**

Research has been formal, systematic & intensive process of currying out vast investigation based on scientific method of analysis [1]. Researcher should have a mind set of following ethics of research before engaging himself/herself in research. As for as scientific research is considered the researcher become prey of self plagiarism and scientific misconduct. Analysis of Ph.D degree holders (30), has revealed that the scientific misconduct and plagiarism in due to severe negligence of their mentors and the hurriedness of submitting thesis/dissertation, keeping mentor unaware of many things.

**Introduction :-**

Scientific research demands extensive experimentation, testing periodicity of the results, generalizing the essence based on periodic testing with whatever has been obtained as research output, highlighting superiority of methods, approaches, over earlier methods, approaches employed by earlier scientific researchers with their due recognition and citations.

The selection of topic for scientific research is crucial step, where both researcher and mentor/guide should pay attention and have an exhaustive study of research outcomes of earlier researchers. The researches and guide/mentor should have deep insight and innovative ideas and design problem accordingly.

After selection of problem researcher should adopt necessary experimental techniques. The researchers should draw scientific conclusion and compare than in the light of earlier research worker's research work and highlight the superiority of the obtained results. If the results are significant, of immense importance on the part of society they can opt for patent and in cash through the research finding.

David B. Resnick [2] has given ethical norms that promote the aims of research, promote the values that are essential for collaborative work, helps to insure that researchers can be held accountable to public, helps to build public support, promote moral and social value. Justine Farrel et.al.[3] Have quoted that growing body of sophisticated research on scientific misinformation can help us to better understand this dynamics and provide the basis for developing co-ordinated set of strategies such as public inoculation, legal strategies, political mechanism and financial transparency.

**Hypothesis :-**

All researcher follow ethical principles of research while executing research endeavor.

**Survey Method :-**

Survey Method has been used for compilation of data, questionnaire has been used for compiling the data. The data of Ph. D degree holder who have obtained their Ph.D degree (Science Faculty) in the last five year has been collected through the questionnaire (30). The researchers there asked to furnish the honest information and they were assured of keeping confidentiality of their names.

**Finding and Analyses :-**

Deborah Smith [4] have a enlisted five principles for research ethics viz. Discuss intellectual property frankly, Be conscious of multiple roles, Follow informed-consent rules, Respect confidentiality and privacy, Tap into ethics resources Sales, B.D., & Folkman, S. [5,6] have given ethical principle of psychologist and code of conduct and Ethics in research with human participants.

The data gathered from questionnaire executed to the Ph.D. degree holder in past five years (Science Faculty) has revealed that 30% of Ph.D. degree holders have copied the quotations, materials, theory from text books, reference books, encyclopedias, information available on the net obtained through different search engines as it is, simply cut and paste they have not taken any pain in expressing the same things in there one words.

They have carried out these malpractices keeping their mentors/research guide unaware of whatever they have done, and reported in their thesis/dissertation. They have got corrected their write ups many a times/many versions. As such it is more duties of mentor/research guide to go thoroughly through the write up submitted by their research students and scrutinize wither they have copied text material, data, figures of the research work published by earlier researchers, notable scientists, Nobel laureates. The mentor/research guide should have meticulous checking of the write-ups submitted by their search students. Many a times loophole remain on the part of research guide while submitting thesis/dissertation in hurriedness.

20% Ph. D. students have committed scientific misconduct they have copied the graphs, tables and changed captions of figures and tables.

The hypothesis has been proved to be false. As some of the scientific researchers have committed scientific misconduct, while some other have become prey of plagiarism while obtaining there Ph. D. degree. They have abused both educational system as will as worsened their own image. Also their scientific misconduct and plagiarism has made society commenting on the highest degree such as Ph. D.

### Conclusion:-

Lack of meticulous scrutiny, testing on the part of mentor of the research guide right from selection of scientific research problem till in the publishing in the form of thesis/dissertation them unaware of whatever has been reported has led to plagiarism and scientific misconduct. These malpractices can be minimized/canceled if University/Institutions, use software's for monitoring plagiarism. The research guide/mentor should enact sincerely, honestly, unbiased manner, properly guiding and rectifying the malpractices of students from time to time. University/Institutions should send the thesis/dissertation of research students to the Scientists/Faculties from Institutions of National importance such as IIT's, IISER's, IISc, CSIR Laboratories. University/Institutions should make the mandatory practice of publishing at least two research papers in Journals of International repute with high impact factor, which should be enclosed as an Appendix at the end of thesis/ dissertation. Rigorous exposure to experimental techniques, non stipulated time for completion and award of a Ph D. degree, extensive and conceptual understanding of the scientific research problem, adequate mind set both on part of researcher and mentor, cordial relations between researcher and mentor should be pre requisite.

### References :-

1. John W. Best & James V. Kahn Research In Education, Prentice-Hall of India Private Limited (2004).
2. David B. Resnick, Bioethicist and Institutional Review(2015)
3. Justin Farrel, Kathryn Mc Connel, Robert Brulle, Nature climate change (2019)
4. Deborah Smith, Monitor Staff, Vol. 34, No. 1 (2003) P. 56.
5. American Psychological Association, Ethical principle of psychologist and code of conduct, American Psychologist Vol. 57 No. 12 (2002).
6. Sales, B.D., & Folkman, S. (Eds.), Ethics in research with human participants, American Psychological Association, Washington, DC: (2000).

## Paper Batteries Using Carbon Nanotube - Coated with Conventional Sheet of Cellulose-Based paper

Sonali Patil<sup>1</sup>, Pournima Kore<sup>2</sup>, Nikita Patil<sup>3</sup>

1, 2, 3 Student, EEE Department, Sanjay Ghodawat Group of Institutes, Kolhapur,

### Abstract-

*This paper presents a complete insight on this revolutionising and satisfying solution for energy storage through biodegradable and also analyse in solving the problem from unbiodegradable energy resources. After the use of unbiodegradable energy resources, a lot of pollution is caused which is contaminating the environment. It is a flexible, ultra-thin device for energy storage and production. It is composed of carbon nanotubes along with sheet of cellulosebased paper. It can be used both as a high-energy battery and super capacitor. By these two types of functioning, it allows the battery to provide both long-term steady power production as well as a lot of energy as power backup regarding capacitors. Being Biodegradable, Light-weight and Non-toxic, flexible paper batteries have potential capability to adapt as a power source for the next generation. Paper battery has the potential to be used in electronics, medical devices and hybrid vehicles(Transformers) and medical technologies. The paper is aimed at understanding & analysing the properties and characteristics of Paper Batteries for the upcoming world; to study its advantages over unbiodegradable energy resources, limitations and disadvantages. This paper also aims at highlighting the construction and since it is the biodegradable and efficient source to replace other sources so finding various methods of mass production of paper battery.*

### Introduction

A paper battery is a flexible energy storage device consists of carbon nanotubes with a conventional sheet of cellulose. A paper battery can be used as high-energy battery and super capacitor, combination of two discrete quantities.

#### **Paper Battery= Paper (Cellulose) + Carbon Nanotubes**

Cellulose which is a complex organic substance found in pulp. It is not digestible by humans. A Carbon NanoTubes (CNT) is a tiny cylinder made up of a single sheet of carbon. these carbon atoms are rolled to form cylinder. Their conductivity is better than best semiconductor and strength is more than steel.



Figure 1: STRUCTURE OF CARBON NANO TUBES

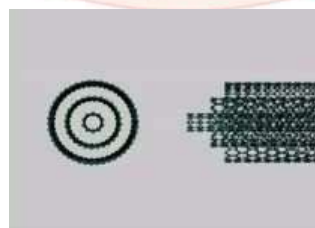

Figure 2: STRUCTURE OF CNT

### 1.1 Properties of Paper Batteries

The properties of Paper Batteries are mainly dependent on the properties of cellulose as well as CNT's Cellulose:

- High Tensile strength; Low Shear Strength
- Biodegradable
- Biocompatible
- Excellent Porosity & Absorption Capacity
- Easily Reusable and Recyclable • Non –Toxic Carbon Nanotubes:
- Width to Length ratio: 1:107 • Tensile strength is more than Steel.
- Lower Mass density.
- Much Lighter and Flexible.
- Higher Electrical Conductivity and Lower Resistivity
- Attaching the Paper and CNT layers multiplies the Output Voltage; Detaching the Paper and CNT layers divides the Output Voltage.
- Thickness is between 0.5-0.7mm.
- Operating temperature range varies from:75°C to +150°C.
- Does not contain heavy metals like Hg, Pb etc.
- Mechanical damage does not lead to overheating and no shipment issue caused by leakage.

### 1.2 Need

The main problem we are facing with present ElectroChemical batteries is:

Limited Life Time Primary batteries irreversibly transform chemical energy to electrical energy but after using for some time they are just a unbiodegradable waste. Secondary batteries can be easily recharged; i.e. it performs its chemical reactions reversed by supplying electrical energy to the cell, restoring their original composition. There is also one major problem with Rechargeable batteries are that these are still costlier than Primary Batteries Leakage In these batteries, a main issue is that as time passes these batteries storage starts declining If leakage occurs ,through accident or anyhow, the chemicals released may be dangerous. The active chemical leakage can then damage the equipment in which the batteries were inserted.

Environmental Concerns The widespread use of batteries has created many environmental problems, such as toxic metal pollution. Metals such as Cadmium, Mercury, Lead, Lithium and Zinc have been identified as highly toxic metals. Batteries may be harmful or fatal if swallowed by young children While in the digestive tract the battery's electrical discharge can burn the body cells and tissues and can be serious enough to lead to death.

### 1.3 Some other Fuels which come in contact to replace these batteries but still have some limitations

The limitations of Fuel cells are:

#### **Cost:**

The fuel cells based on hydrogen are costly for general consumer use, hence it is restricted to rocket launch vehicles. Liquid Hydrogen and Hydrogen Peroxide is essential ingredients that make them costly.

#### **Portability & Size:**

Fuel cells are larger in size, which reduces portability and makes it very difficult for use in electronic and medical gadgets.

The limitations of Solar Cells are:

#### **Versatility:**

Solar cells cannot be used in many situations, like Emergency Power-Backup, Emergency Energy Purge.

#### **Adaptability:**

Solar cells cannot be used in all battery-powered Equipment.

#### **Portability & Size:**

They are not at all portable or robust hence during failures an auxiliary back-up battery is required for solar cells.

### 1.4 Construction

The process of construction consists of the following steps: Firstly, a common Xerox paper of desired Shape and Size are taken.

- CNT ink is spread over paper using Mayer Rod method • The strong capillary force in paper enables high contacting surface area between the paper and nanotubes after the solvent is absorbed and then it is dried out in an oven.
- Paper battery is composed of a thin lithium film laminated over the exposed cellulose, which can be connected to the external load via aluminum current collectors.
- It is similar to an electrochemical battery except with the constructional differences mentioned before the procedures.

## Description

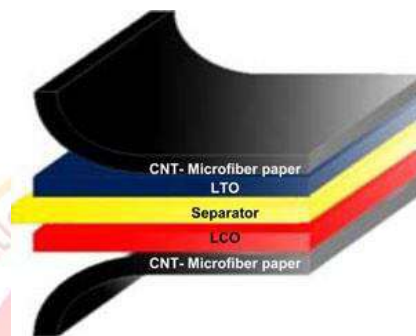

Figure3

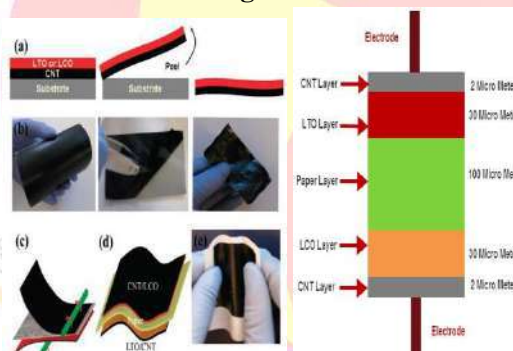

Figure4

Lithium Ion Battery during discharging

### 1.5 Advantages

- Biodegradable & Non-Toxic: it is a biodegradable and nontoxic product as its major ingredients are of organic origin,
- Biocompatible: our body's immune system does not easily reject them if implanted into human body.
- Easily Reusable & Recyclable: It is easily recyclable and reusable, even with the existing paper recycling techniques
- Durable: It has a shelf life of almost 3 years. Under extreme conditions it can operate within  $-75^{\circ}$  to  $+150^{\circ}\text{C}$ .
- Rechargeable: It can be recharged more than 250 times using almost all electrolytes, including bio-salts such as sweat, urine and blood.
- No Leakage & Overheating: Due to low resistivity, it does not get overheated even under extreme conditions. As there is no any kind of leaky fluids, there is no leakage problem even under spontaneous or accidental damage.
- Very Light Weight & Flexible.
- Easily Moldable Into Desired Shapes & Sizes.
- Customizable Output Voltage:
- By varying CNT concentration.
- By stacking & slicing.



1.6 Applications

As it is the latest technology which can easily reduce the size and weight of modern technologies, so it is going to be used in many fields. Some of them are:

- In Electronics: By replacing the alkaline batteries with light-weight paper we can reduce the weight of laptop batteries, mobile batteries etc. In wrist watch, calculators, and similar low drain devices. In wireless communication devices like Speakers, Bluetooth headsets etc.
- In Medical Sciences: , in Artificial tissues (using Carbon nanotubes) and Pacemakers for the heart
- In Cosmetics, Drug-delivery systems.
- In Biosensors- Glucose meters and sugar meters.
- In Automobiles and Aircraft
- In Hybrid Car Batteries
- In Long Air Flights reducing Refueling
- For Light weight guided missiles
- For powering electronic devices in satellite programs.



Figure 5

Literature Review

Paper battery mainly constitutes of carbon nanotubes. At carbon nanotubes, significant works have been carried out independently, by Pushparaj et al.[2007] and Yi Cui et al.[2010] in the field of preparing the first prototypes. Initially the designs of flexible energy-storage devices were based on separated thin-electrode and spacer layers, which were providing less-than-optimum in performance and handling. Pushparaj et al. demonstrated the fabrication of ‘electrode-spacer electrolyte. Yi Cui et al. have revived the attempt to integrate the components on to a single unit in a much simpler and more promising way. In this paper, they integrated all of the components of a Li-ion battery into a single sheet of paper just by doing simple lamination process. Even though the paper-like membrane were used as the separator for other energy storage systems including super capacitors, it was the first example of the Li-ion batteries with commercial paper, where paper can be used in two ways as a, separator and mechanical support. Dr. Mangilal Agrawal, Louisiana Tech University has made another attempt to exploit the properties of Paper batteries. Having done much work with biosensors and bio-capacitors, he successfully demonstrated how the relative proportion of CNT and Paper could be used to customize the voltage output of the Paper Battery. As this field is so promising and potent, there is a huge amount of work done over Paper Batteries and CNTs. However, the entire work in literature is neither comprehensible nor easily accessible.

Comparison between Paper Battery (Super Capacitor) And Li-Ion Battery

PERFORMANCE COMPARISON	BETWEEN SUPERCAPACITOR AND LI-ION	
	Supercapacitor	Lithium-ion (general)
Function		
Charge time	1-10 seconds	10-60 minutes
Cycle life	1 million or 30,000h	500 and higher
Cell voltage	2.3 to 2.75V	3.6 to 3.7V
Specific energy (Wh/kg)	5 (typical)	100-200
Specific power (W/kg)	Up to 10,000	1,000 to 3,000
Cost per Wh	\$20 (typical)	\$0.50-\$1.00 (large system)
Service life (in vehicle)	10 to 15 years	5 to 10 years
Charge temperature	-40 to 65°C (-40 to 149°F)	0 to 45°C (32° to 113°F)
Discharge temperature	-40 to 65°C (-40 to 149°F)	-20 to 60°C (-4 to 140°F)

Source: Battery University

Figure 6: paper battery and lithium-ion battery

### Limitation And Disadvantages

No technology is 100% advantageous, there are some pros and cons to each and every technology.

It would not be logical only to fall over the advantageous properties and applications of Paper Batteries.

Following are some of them:

- Due to Low Shear strength, they can be easily torned.
- The Techniques and the Set-ups used in the Production of Carbon Nanotubes are very less Efficient and much expensive. Like : Chemical Vapour Deposition (CVD), Arc discharge, Electrolysis, Laser Ablation,.
- When inhaled, their interaction with the lungs is similar to that with Asbestos fibers, hence may be seriously hazardous to human health.

### Results And Conclusion

Energy crisis is one of the major bugging problem faced by the world today. Every nation needs energy and everyone needs power. And this problem which disturbs the developed countries and the developing countries like India to high extent. Talking about a point where there can't be a day without power, which can be overcome with the help of Paper Batteries. Being Biodegradable, Light-weight and Nontoxic, flexible paper batteries have potential adaptability to power the next generation of electronics, medical devices and hybrid vehicles, allowing for radical new designs and medical technologies. About self dependant for energy solution, India has a long way to go for. Literature reflects that scientific astuteness required for such revolutionary work is always there with Indian researchers. But because of lack of facilities and funding it is not working and this paper is just a single step towards this direction.

### References

1. Pushparaj V. L., Manikoth S. M., Kumar A., Murugesan S., Ci L., Vajtai R., Linhardt R. J., Nalamasu O., Ajayan P. M. "Flexible Nanocomposite Thin Film Energy Storage Devices". Proceedings of the National Academy of Science USA 104, 13574-13577, 2007. Retrieved 2010-08-08.
2. Hu, L. C., J.; Yang, Y.; La Mantia, F.; Jeong, S.; Cui, Y. Highly Conductive Paper for Energy Storage. Proc. Natl. Acad. Sci. U.S.A. 2009, 106, 21490–21494.
3. Beyond Batteries: Storing Power in a Sheet of Paper". RPI. August 13, 2007. Retrieved 2008-01-15.
4. Paper battery offers future power". BBC News. August 14, 2007. Retrieved 2008-01-15
5. Katherine Noyes. "Nanotubes Power Paper-Thin Battery". TechNewsWorld. Retrieved 2010-10
6. Ng, S. H. W., J.; Guo, Z. P.; Chen, J.; Wang, G. X.; Liu, H. K. Single Wall Carbon Nanotube Paper as Anode for Lithium-Ion Battery. Electrochim. Acta 2005, 51, 23–28.
7. Hu, L.; Hecht, D.; Gruener, G. Carbon Nanotube Thin Films: Fabrications, Properties, and Applications. Chem. Rev. 2010, doi: 10.1021/cr9002962

## Ethical Considerations In Conducting Research

**Dr. Nagappa P. Shahapur,**  
Professor of Education,  
Karnatak University, Dharwad- 580 003.

The selection of a research topic carries with it the obligation to behave ethically. A code of ethics prescribes the general conditions under which the investigator may and may not conduct research. The success of the research process depends on the same principles and ethical behavior which are to be possessed by the investigators and also guiding professionals.

Medical and Psychological experimentations using human subjects involves some element of risk, however minor and raises questions about the ethics of the process of the Research. Any set of rules or guidelines that attempt to define ethical limits for human experimentation raises controversy among scientists and other segments of society.

The following principles should be considered in planning and conducting research with human subjects.

1. **Acceptance of Personal Responsibility and Review** The researcher attempts the responsibility for following certain principles involved in conducting research with human subjects. It is especially important that the researcher obtain advice and guidance from institutional review committees advisers or colleagues regarding behaviour of participants that may be harmful damaging, anxiety producing etc., Advice to proceed will ordinarily be given only if the benefits of the proposed research outweigh the potential harm to the participants.
2. **Informed Consent** The researcher has the responsibility to inform participants of those conditions that might affect their decision to participate in the study. This disclosure implies that question by potential participants be answered by the researcher.
  - a) **Unobtrusive Public Observation** Sometimes researchers engage in studies where they observe individuals who are unaware of their participation in research study. If participants remain completely anonymous, the problem of obtaining consent is somewhat lessened. But if individuals can be identified even though their behaviour may be public, asking individuals to give their consent for the use of data is recommended.
  - b) **Invasion of Privacy**

It is justifiable to observe and record behaviour that is essentially public, behaviour that others normally would be in a position to observe. It is an invasion of privacy to observe and record intimate behavior that the subject has reason to believe is private concluded observers, camera, microphones or use of private correspondence without the subjects knowledge and permission are invasions of privacy. If these practices are to be employed, the participant's understanding of the reasons should be explained and permission secured. Some of the intimate behaviour cannot be observed ethically.
  - c) **Intrusive, Disguised and Observations**

Intrusive research involves manipulating the behaviour of the respondent. Such manipulations are disguised if respondents are unaware that they are participating in a study.
  - d) **Evaluation Studies and Other-Research** in Institutions
 

Sometimes a decision must be made whether to introduce a particular treatment or method to individuals in an institution such as a school. For example, researcher wants to evaluate a text being used in a school by testing the students. Or students in a control group may be tested even though they received no, benefit from a study. Although informed consent would be desirable in these studies. The potential harm to subjects is minimal and is especially so when subjects normally expect to be tested even though they received no benefit —..As, A lf hnuoli informed consent would be desirable in these studies.will ordinarily be given only if the benefits of the proposed research outweigh the potential harm to the participants.

It is important to realise that informed consent implies that potential participants in a research study are competent to give their consent. When working with minors, mentally retained, consent should be obtained from guardians, or superintendents of respective institutions.

3. **Freedom from Coercion** Individuals should not be forced to participate in research as a requirement for enrollment in a course unless it can be demonstrated that are participating in a study. If students are allowed reasonable requirement before they enroll.
4. **Anonymity and Confidential** The participant has the right to know which persons are privy to personal information obtained during the course of an investigation. If possible data should be obtained anonymously to avoid the possibility that any individual could be identified.

Participants must be fully informed to conditions. Some studies require a comparison of participant responses on two or more occasions. Under such conditions, participants must be informed that identification is necessary. Here, the researcher holds all information about the subject in strict confidence. Information should not be released without his/her permission.

5. **Honoring Agreements with Subjects** For research to be ethical, the participants and researcher must have a clear understanding of their respective role, their agreement must be fair and the researcher must fulfil all commitments. Any promises must be honored.
6. **Protection Against Risk** Subject is placed at risk if the study involves physical or emotional danger or potential danger. The investigator has the obligation to reduce all forms\_ of stress. Research on human being subjects unethical if it is likely to produce long term and serious problems.
7. **Clarification and Explanations of the Study** At the termination of a study, the investigator has the obligation to debrief all participants. If providing such information puts the participant in greater risk than would otherwise have been likely, potentially damaging information may be withheld. For example, children who were told they had performed well during an experiment need not be told afterward that their performance was actually poor.
8. **Protection from Physical and Mental Stress, Harm or Danger** In using treatments that may have a temporary or permanent effect on the subjects. The researcher must take all precautions to protect their well being. Thorough precautions and safeguards may be assured.
9. **Diagnosing and Eliminating Undesirable Experimental Effects** any possible stressful conditions, physical or mental, must be detected and eliminated as rapidly as possible. The investigator needs to consider the possibility of such effects and either prevent them or forego the study. Follow up procedures should be planned and provide students with tasks on which they do extremely well to minimize previous negative treatment effects.

10. **Knowledge of Outcome** The participant has right to receive an explanation for the reasons for the experimental procedures and the results of the investigations. The researcher may explain the results and their significance orally or by issue the journal in which the report has been published.

11. **Acceptance of Research Funds** Researchers needs to make use of research funds for them. Purpose of investigation only from the funding agencies. Records must be maintained.

12. **Potential Misuse of Research Findings** The researcher needs to consider the potential effects and possible misuses and misinterpretations of research findings. To be sure. The result of any study can be misunderstood and used for socially undesirable goals. We should not misuse research findings. Variables cannot be manipulated. The ethical probleins that would be raised if some other were manipulated indicates a place. for such non experimental methods as exposed factor research. The researcher starts with the observation of dependent variables and goes back to the observation of independent variables that have previously ocured under uncontrolled conditions.

Statement of principles places a considerable emphasis on the personal responsibility of researchers to act ethically and to promote ethical behaviour in all aspects of research activities acknowledges the importance of the professional codes of conduct of external agencies and organisations, and accords them primacy as a default position.

13. **Towards research participants** Researchers have a responsibility to ensure as far as possible that the physical, social and psychological well-being of their research participants is not detrimentally affected

by the research. Research relationships should be characterised, whenever possible, by mutual respect and trust.

**14. Towards other researchers** Researchers should avoid, wherever possible, actions which may have deleterious consequences for other researchers or which might undermine the reputation of their discipline. Those directing research should bear in mind their responsibilities towards members of their research teams and should aim to anticipate and guard against the possible harmful consequences of the research for team members.

**15. Informed Consent** Research should be based, as far as possible and practicable, on the freely given informed consent of those under study. However, it is recognised that in some cases it may be necessary to employ covert methods should these constitute the only means to obtain the required data.

In such cases,

It is the responsibility of the researcher to explain as fully as is reasonable and appropriate, and in terms meaningful to the participants: the aims and nature of the research, who is undertaking it, who is funding it, its likely duration, why it is being undertaken, the possible consequences of the research, and how the results are to be disseminated.

The power imbalance between researcher and researched should be considered. Care should be taken to ensure that the latter are not pressurised into participation. Research participants should be aware of their right to refuse participation at any time, including withdrawal from a research project at any stage, and should not be given the impression that they are required to participate. It should also be recognised that research may involve a lengthy data-gathering period and that it may be necessary to regard consent not as obtained once and for all, but subject to re-negotiation over time.

The researcher should explain how far research participants will be afforded anonymity and confidentiality and participants should have the option of rejecting the use of data-gathering devices such as tape-recorders, video cameras, and digital recording devices.

If there is a likelihood of data being shared with or divulged to other researchers, the potential uses of the data should be discussed with the participants and their agreement to such use should be obtained.

Where access to a research setting is gained via a 'gatekeeper' external to the University, researchers should also obtain the informed consent of research participants, while at the same time taking account of the gatekeeper's interests. It should be borne in mind that the relationship between research participant and gatekeeper may well continue long after the research has been undertaken.

Where research participants are young children or other groups that may be made vulnerable in or by specific social conditions relevant to the research such as elderly, disabled or sick people, or people with learning difficulties whose understanding is impaired in some way so that they are unable to give full informed consent, it may be necessary to use a proxy in order to gather data. In this case great care must be taken not to intrude upon the privacy of the vulnerable participants. The researcher should consult relevant professionals, carers, parents/guardians and relatives, as appropriate. Researchers should attempt to obtain the informed consent of children and their parents and in relation to schoolchildren those who are *in loco parentis*.

In addition to obtaining the informed consent of those under study, researchers should attempt to anticipate and guard against the possible harmful consequences of their research for participants.

#### **Deceptive and Covert Research**

While it is recognised that there is a continuum of covert-overt research (and therefore difficulty in defining research simply as entirely covert or overt), researchers should endeavour, wherever possible and practicable, to avoid the use of deception in their research methods, as this violates the principle of informed consent and may invade the privacy of those under study, particularly in non-public spaces.

Any researcher considering deceptive methods in research must seek approval from the relevant Faculty Research Ethics Panel (FREP) or Research Ethics Sub-Committee as appropriate (see Part B, s3 & 4). The burden of proof will rest on the investigator to show that no alternative methods are possible, and that the data sought are of sufficient value to over-ride the issues of free and informed consent. Where approval has been given, the potential implications arising from publication must be fully considered.

Covert research in non-public spaces (that is, where persons would not normally expect to be under observation), or experimental manipulation of research participants without their knowledge should be a last resort when it is impossible to use other methods to obtain the required data. It is particularly important in such cases to safeguard the anonymity of participants.

If covert methods are approved and employed, and informed consent has not been obtained prior to the research, every attempt should be made to obtain this post hoc.

#### **Confidentiality and Anonymity**

The anonymity and privacy of research participants should be respected and personal information relating to participants should be kept confidential and secure. Researchers must comply with the provisions of the data protection act and should consider whether it is proper or appropriate even to record certain kinds of sensitive information.

Where possible, threats to the confidentiality and anonymity of research data should be anticipated by researchers and normally the identities and research records of participants should be kept confidential, whether or not an explicit pledge of confidentiality has been given.

Whilst the researcher should take every practicable measure to ensure the confidentiality and anonymity of research participants, s/he should also take care not to give unrealistic assurances or guarantees of confidentiality. Research participants with easily identifiable characteristics or positions within an organisation should be reminded that it may be difficult to disguise their identity totally without distorting the data. All students will be offered appropriate education and training in research ethics in their Research Methods Module or its equivalent.

**Integrity:** Researchers are required to demonstrate intellectual and moral honesty in proposing, conducting, and reporting research. Truthfulness and responsible conduct underlie the integrity of research proposals, information, data, analyses, reports, and publications.

**Accountability:** Researchers must take responsibility for their actions and their commitments to research. They are expected to promote public transparency throughout the research process and adhere to applicable policies the research in which they engage must be open to monitoring and verification.

**Independence and Impartiality:** Researchers must ensure that personal views, convictions, previous experiences or future ambitions do not compromise the objective scientific process.

**Respect for persons and communities:** Researchers must engage in research based on the respect of the dignity of persons and communities. This means taking into account the underlying inequalities and the diversity of persons and communities, and to strive for equity and justice in health research.

**Professional Commitment:** Researchers are required to build their professional competence on a foundation of integrity, scientific knowledge, and personal commitment to advancing health for all. Objectivity, accuracy, efficiency, and impartiality are expected.

The quality of the research and the value of the knowledge achieved depend intrinsically on the integrity of those performing the research. Honesty, truthfulness, and transparency not only contribute to the accuracy and reliability of the scientific activity and its outcomes, they also form the foundation for public trust and good health policy resulting from research.

ethics of consciousness enriched by dialogue and supported by a careful awareness of the needs and sensitivities of persons, communities, and cultures. Staff need to be particularly sensitive to the expectations of persons and communities participating in research as well as the impact of the research on those persons and communities. In this context, the term wrongdoing in research means **intentional, fraudulent or grossly negligent behaviour that breaches the principles of this Code. Such behaviour includes without being limited to:**

- Inappropriate development of research protocols;
- Failure to disclose or take action on declared conflict of interest;
- Inadequate management of a research project;
- Fabrication, falsification, plagiarism, deliberate misrepresentation or other practices that deviate from this *Code* and from the academic and scientific communities' commonly accepted norms<sup>11</sup> for proposing, conducting or reviewing research or for reporting research results.

Wrongdoing in research does not include honest errors or honest differences in interpretations or judgements of data. It also is different from other forms of questionable research practices, or poor practice, which can include inadequate data management and research procedures.

**Applying standards of good practice in the conduct of research** good practice standards cover training and supervision, conflict of interest, research ethics, the management of research data, research procedures, contractual and other collaborative arrangements, publication, dissemination and authorship, and peer review.

**Adherence to research standards** Researchers are required to be familiar with, appreciate, and adhere to high scientific and ethical standards when engaged in research. All members of the research team are aware of the requirement to comply with the principles of this *Code* and of their duty to report any departures from its principles, to their supervisors, to the leader of the research team, or through the Integrity Hotline in cases where this may be problematic.

**Research training and supervision** It supports research of high scientific and ethical standards, professionalism, cooperation, and the open and honest exchange of ideas. Research responsibilities and good research practices, including research ethics, are essential to achieving excellence in research, in both policy and practice.

**Managing collaboration in research** Managing collaboration with other institutions or researchers is essential to good research practice.

**The financial management of research** Good financial management of research projects is essential to the support and integrity of research and its outcomes. The financial terms and conditions of research funding need to be defined clearly in all research contracts.

- Ensure the appropriate management of resources and provide accountability for the use made of financial resources throughout the research;
- Report in a timely and transparent way any deviations or irregularities regarding the use of research funding; and Facilitate the monitoring and audit of finances related to the research.
- Ensure the research team has the necessary skills, training, resources, and support to carry out the proposed research;
- Ensure good data management, including the planning, generation, documentation, analysis, use, storage, and appropriate destruction of data;
- Maintain and make available research documentation for scientific, ethical, and regulatory review as well as for peer review and publications review procedures.

**Managing and monitoring research data** good data management practices in all research. This includes the appropriate collection, retention, use, dissemination, and destruction of research data. Institution should support good research oversight practices, including the monitoring and auditing of ongoing and completed research.

**Intellectual property and authorship** upholding intellectual property regulations in research, and not to violate third party intellectual property rights. This includes research ideas, processes, and materials as well as research data, reporting, and publications.

However, there is need of ethical consideration, in conducting research. Care must be taken into all phases of investigation.

## The New Record Of *Apanteles Papiliones*(Hymenoptera: Braconidae) As A Biocontrol Agents Of Lime Butterfly *Papilio demoleus* (Lepidoptera: Papilionidae) From Warnanagar, Western Maharashtra.

P. M. Bhoje K.M. Charaple, & Bhusnar A. R.

Department of Zoology  
Yashwantrao Chavan Warana Mahavidyalaya, Warananagar.

### Abstract

*Lepidopteron larva grows on the plant foliage, due to plantation of hybrid variety and more profitable farming methods in Maharashtra some of the minor pests become a major pests. For control this pests farmers use tremendous pesticides in various agro ecosystems of India. Pesticides lead serious problems such as pest resistance, air pollution, water pollution; soil pollution etc. leads to several cancers like harmful diseases. However, bio-control is very good alternative for chemical control. Parasitoid *Apanteles papiliones* is first time reported as an effective parasitoid over *Papilio demoleus* from Warana region of Western Maharashtra. It was observed that 70% larvae of *P. demoleus* from citrus orchard of Warana nursery were infested by *A. papiliones*. After Observation authors are concluded that *A. papiliones* effective biocontrol agents of *P. demoleus*.*

**Key words:** Parasitoid, Warana, bio-control, *Apanteles papiliones*, *Papilio demoleus*

### Introduction

Butterflies (Insecta: Lepidoptera) counts in the unique feature of the area. India host 1501 species of butterflies (Goanker, 1996); of which peninsular India host 350. Butterflies are good pollinator, attractive, indicator of environmental qualities. However, their larval forms grow on the plant foliage, due to more profitable farming methods in Maharashtra some of the minor pests become a major pests e.g. Cabbage butterfly (*Parasitoid* *Paris rapae*), Lime butterfly (*Papilio demoleus*) commonly called as lemon, citrus or checkered swallowtail, it is found throughout southern Asia (Corbet and Pendlebury, 1992.) extending from Iran (Larsen, 1977.) and the middle east India and from Indo Pacific (Van-Wright and Jong, 2003) to New Guinea and Australia (Parson, 1995; Barby, 2000.) Its principal host is the genus *citrus* (Rutaceae). In India this butterfly has been discovered as important citrus pest which rapidly expanding is known as plague of citrus grove not only India but Saudi Arabia and Iran Badawai, (1981). Narayanamma, *et al.*(2001) reported up to 83% defoliation of young grove trees in Andhra Pradesh. Thakare and Borale, (1974) reported an outbreak severe enough to skeletonized entire citrus garden. The larvae prefer young nursery plant grown 1 to 2 feet height and completely defoliate nursery Yunes and Munir, (1972)

Studies of natural source mortality by nematodes (*Steinernema* sp. Nematoda: Rhabditida: Steinernematidae) was reported by Singh, (1993b) in control of caterpillars of *P. demoleus* in India and Bidawi, (1981), who reported pupal mortality caused by application of *Bacillus thuringiensis*. Thakare and Borale published a photograph of unidentified dipteran parasitoid, are suggested to regulate local population of *P. demoleus*.

First time we have reported a parasitoid *Apanteles papiliones* efficiently parasitizing *P. demoleus* from Western Maharashtra. It was observed that 70% larvae of *P. demoleus* from citrus orchard of Warana nursery were infested by *P. demoleus*

### Methods And Methodology

*P. demoleus* larvae were collected from citrus orchard of Warana plant nursery and were reared feed daily with fresh leaves of citrus plant up to 20 days. Maintain this larval culture for parasitoid screening and observation were noted, photograph were taken, infested larvae were kept in the large sized test tube to collect emerged parasitoid from it. Parasitoid preserved by pinning method and some of them kept in 70% alcohol for further identification.

### Result And Discussion

First time observation made on *Apanteles papiliones* regarding biocontrol agents for *P. demoleus*. *A. papiliones* having a good bio-control potential to control *P. demoleus*. A collected and reared larva of *P. demoleus* was found infested by *A. papiliones*. Host larvae of about second instars (fifth to six day old) were preferred to ovipositor and within 12 to 16 days larvae of parasitoids grown inside the host larvae and after completion of larval growth they make pore in host larval body from inside and come outside at a time. Large number of larvae prefer to come out from ventro-lateral sides of five to eight segments of abdomen of the host larva, those larvae emerged from dorsal sides of the host larva they rolled down under side of the host and then spin their cocoons in gregarious condition. Were also observed that isolated, solitary larvae of *A. papiliones* was failed to spin its cocoon. Host larvae live up to two days after emergence of parasitoid and then die.



There is tremendous pressure of pesticides because of its indiscriminate use in various agro ecosystems of India. Pesticides lead serious problems such as pest resistance, air pollution, water pollution; soil pollution etc. leads to several cancer like harmful diseases. However, bio-control is very good alternative for chemical control. Brconids ( Hymenoptera: Broconidae) parasitic flies are highly potential bi- control agents. The parasitoids is an intermediates term which inherits the qualities of predators of true parasite which has been used first by Reuter ( 1913) The parasitic larva kill their hosts in the process of their development and they always act as entomophagus but the adults are free living and mostly vegetarian. *A. pailiones* may be used to control against the devastating defoliator *P.demoles*



Fig. 1. Host larva *Papiliones demoleus* and emerging parasitoids of *Apanteles papilionis*  
2. Host larva and cocoons of parasitoid 3. Parasitoid cocoons 4. Dead host larva and adult parasitoids emerged. 5 and 6. Infested Host larva showing emergence pores

### Acknowledgement

I am grateful to Principal of Y. C. Warana Mahavidyalaya, Warananagar for providing basic facilities for this study.

### References

1. Alturi, J.B., S.P. Raman and C. S. Reddi, 2002 Life history of *Princepsdemoleus* ( *Lepidoptera: Rhopalocera: Papilionidae* ) From India . *J. Nstl. TaiwanMus.* 55:27-32
2. Badawi, A 1981. Studies on some species of the biology and ecology of the citrus butterfly *Papilio demoleus* L. Saudi Arabia. Pailionidae, Lepidoptera. *Z. Angeq, Entomol.*, 91: 286-292.
3. Barby, F.2000. Butterflies of Australia, their identification, biology, and distribution, CSIRO Publishing , Collngwood, Victoria, Australia.
4. Chatterjee, H., J. Ghosh and S. K. Senapati 2000. Influence of important weather parameters on population fluctuation on major insect pest of mandarin orange( *Citrus reticulata* Balnco) at Daarjeeling sliatract of West Bengal ( India). *J. Entomol Res.* (New Delhi).24:229-233.
5. Corbet, A.S. and H. M. Pendlebury. 1992 The Butterflies of the Malay Peninsula, 4<sup>th</sup> ed. Malayan Nature Society, Kuala Lumpur.
6. Larsen, T. B. 1977. Extention recent en Iraq de l'aire de *Papilio demolus* Lnn.Entomops 42: 37-38.
7. Matsumoto, K.1996. Establishment of *Papilia demoleus* L. (Papilionidae) in Java. *J. Lepid. Soc.*50:139-140.
8. Matsumoto, K.2002. *Papilia demoles* L. (Papilionidae)in Borneo and Bali.
9. Narayanamma, V.L., P. Savithri, and R. Rao. 2001. Influence of citrus butterfly Papolio demolesus L. damage on growth parameter of the sweet orange host plant. *Indian J. Plant Port.* 29: 140-141.
10. National Agricultural Statistic Service.2004.USDA Citrus Fruit Final Estimates, 1997.2002. *US Dep. Agric. Stat. Bull.* 997(4): 1-30
11. *Parson, M.* 1998. The Butterflies of Papua New Guinea: Their systematic and biology . *Princeton University Press Princeton, N. J.*
12. Singh , S. P. 1993a Species composition of diapauses in citrus butterflies . *J. Insect. Sci.* 6: 48- 52
13. Singh , S.P. 1993b Effectiveness of an indigenous entomophilic nematode against citrus butterflies . *J. Insect Sci.* 6: 107-108
14. Thakare, K.R. and M. N. Borle. 1974. Outbreak of lemon butterfly in Maharashtra India. *Punjanbrao Krishi Vidayapeeth Res. J.* 2:82-85.
15. Tilden, J.W. 1968. Records of two species of exotic Lepidoptera captured in California *J. Lepid. Soc.* 22:187.
16. Vane-Wright, R. I. and R.de Jong. 2003 The butterflies of Sulawesi: annotated checklist for a critical island fauna. *Zool. Verh.* (Leiden). 342:3-267.
17. Yuns, M. and M. Munir. 1972 Host plants and host preference of lemon butterfly, *Papilio demoleus*. Linn. Caterpillars. *PakistanJ. Zool.*4: 231-232

**Role Of Botany In Climate Change By In-Situ Conservation Of Plants****Dr. Sanjay Y. Jadhav**

Assist. Prof. and Head,

Department of Botany, Y.C. Warana Mahavidyalaya, Warnanagar

Climate change refers to the impact of an ever warmer planet brought by increased levels of greenhouse gases such as carbon dioxide, methane and nitrous oxide that are trapped in the atmosphere. According to IPCC, "climate change refers to a change in the state of the climate that can be identified by changes that persists for an extended period, usually decades or longer. It refers to any change in climate over time, whether due to natural variability or as a result of human activity."

I quote "Climate change has become an urgent and pervasive preoccupation across the globe. It's a Global challenge which requires an ambitious Global response. India and other developing countries would be among those most seriously impacted by the consequences of Climate change". – *Ex Prime Minister, Dr. Manmohan Singh.*

The term "climate change" encompasses all forms of climatic inconstancy (that is, any differences between long-term statistics of the meteorological elements calculated for different periods but relating to the same area) regardless of their statistical nature or physical causes.

The term "climate change" is often used in a more restricted sense, to denote a significant change (such as a change having important economic, environmental and social effects) in the mean values of a meteorological element (in particular temperature or amount of precipitation) in the course of a certain period of time, where the means are taken over periods of the order of a decade or longer.

**Importance of Botanical Gardens to reduce CFC gases :**

The first Botanical Garden was created by Theophrastus in Greece. The credit of first modern Botanical Garden in 1543 goes to an Italian researcher Luca Ghini of Pisa. The first Botanical Garden in India was established in 1787 at Calcutta. Today India represents a chain of botanical garden distributed in all regions of country. After ratification of CBD by India MoEF and state Forest departments launched various schemes like 'National Action Plan on Bio-diversity Conservation, Capacity Building in Taxonomy, Assistance to Botanical Gardens etc.' Presently total botanical gardens listed by BGCI (Botanic Gardens Conservation International) are 1846 distributed in 148 countries. They maintain 4 million living plants representing about 80,000 species along with other collections in the form of herbaria. Thus botanical gardens play crucial role as centers for Conservation, rescue, rehabilitation of rare, endangered and extinct prone plants.

The over burden of population over the natural resources for food, fodder, medicine, shelter etc. we are utilizing our limited resources recklessly. We are burning oil and coal which is a major source for carbon emission which is leading to climatic change and global warming. Man has realized the effects of these activities which is threat to his own survival. Therefore conservation of biodiversity is an important issue and concern of every man, community and every country.

We have to make serious efforts to reduce carbon in atmosphere and many new programs are initiated to bring down atmospheric carbon for which plantation of fast growing trees is considered to be very effective way and now known as carbon crediting. Therefore all over the world efforts are being made of conservation of biodiversity through various plantation programs. In-situ conservation is the best way to conserve in which **Botanical Gardens** seems to be most ideal for conservation of endemic, endangered and endemic species which are economically important.

Under National Mission for a Green India, Botanical Gardens play an important role in conservation of plants along with other gardens, Parks and Devraies. The plants which are botanically important and includes in study of life sciences are cultivated in the Botanical gardens. These gardens are maintained by Research Institutions, Universities and Science colleges. Botanical gardens include naturally occurring plants as well as specially grown plants like succulents and cacti, hydrophytes, palms, exotic plants, conifers, ornamental plants etc.

Under the scheme of 'National Action Plan on Bio-diversity Conservation, Capacity Building in Taxonomy, Assistance to Botanical Gardens etc.' Department of Forest and Environment have sanctioned some amount to the Shivaji University, Kolhapur to build infrastructure for 'Lead Botanical Garden' in University campus. The work of the garden was started in 1996 and now it is in young stage. The garden is divided in to 15 different sections according to plant classifications.

Taking an ink-link from this, our college has also taken an active part in developing our campus lush green by performing 'Green Audit' of Campus as well as developing botanical garden in 'Unique Botanical Garden'. The warnanagar is situated at 16° 45' N and 74° 10' 30" E in Kolhapur District. It is 585m above

MSL and soil type is red alluvial. The garden was established in 1970 over a one acre land . It is estimated to support 380 plant sps. Addition of endemic and endangered plants is still in process. Our garden supports 160 angiosperm plants belonging to 64 families in addition to many seasonal plants. This garden is also having 7 Bryophytes,9 Pteridophytes, 17 cacti and 8 gymnosperms,6 Algae etc. The garden is regularly visited by students of our science faculty as well as M.Pharm., B.Pharm., Bio-tech students as well as by school students and other visitors.

The present paper deals with the various issues of climate change, its effect on environment, Causes of Green House Effect, Its impact on Agriculture and Human being and mitigations to get rid from this hazardous issue etc.

### Causes of Climate Change:

The anthropogenic causes are responsible for increasing concentration of Green House gases. Climate Change is caused by accumulation of GHGs in lower atmosphere due to combustion of Fossil Fuel, **Deforestation**, Vehicular pollution etc. The concentration of CO<sub>2</sub> has increased 30% since preindustrial time.

A layer of greenhouse gases – primarily water vapor, and including much smaller amounts of carbon dioxide, methane and nitrous oxide – act as a thermal blanket for the Earth, absorbing heat and warming the surface to a life-supporting average of 59 degrees Fahrenheit (15 degrees Celsius). Global warming is due to **Green house Effect that results when the atmosphere traps heat radiating from Earth toward space.**

Certain gases in the atmosphere behave like the glass on a greenhouse, allowing sunlight to enter, but blocking heat from escaping.

- **Gases that contribute to Global Warming**

- **Water vapor:** The most abundant GHG, it acts as a feedback to the climate. Water vapor increases as the Earth's atmosphere warms, but so does the possibility of clouds and precipitation, making these some of the most important feedback mechanisms to the greenhouse effect.

- **Carbon dioxide (CO<sub>2</sub>): A minor but very important GHG.** It is released through natural processes such as **respiration** and volcano eruptions and **through human activities such as deforestation, land use changes, and burning fossil fuels.** Methane: Methane is a far more active greenhouse gas than carbon dioxide, but is much less abundant in the atmosphere.

It is produced both through natural sources and human activities, formed during decomposition of wastes in landfills, in agriculture rice cultivation, ruminant digestion and manure management associated with domestic livestock.

- **Nitrous oxide:** A powerful GHG produced by soil cultivation practices, especially the use of commercial and organic fertilizers, fossil fuel combustion, nitric acid production, and biomass burning.

- **Chlorofluorocarbons (CFCs):** Synthetic compounds of entirely of industrial origin used in a number of applications as coolant in refrigerator.

### Consequences:

1. Deaths from global warming will double in just 25 years -- to 300,000 people a year.
2. Global sea levels could rise by more than 20 feet with the loss of shelf ice in Greenland and Antarctica, devastating coastal areas worldwide.
3. Heat waves will be more frequent and more intense.
4. Droughts and wildfires will occur more often.
5. More than a million species worldwide could be driven to extinction by 2050.
6. Scientists expect that the Arctic Ocean may become ice-free before 2030, for the first time in more than 700,000 years.

### Effect on Indian Agriculture :

1. Food production in India is sensitive to climate changes such as variability in monsoon rainfall and temperature changes within a season.
2. Studies by Indian Agricultural Research Institute (IARI) and others indicate greater expected loss in the Rabi crop. Every 1 °C rise in temperature reduces wheat production by 4-5 Million Tones.
3. Small changes in temperature and rainfall have significant effects on the quality of fruits, vegetables, tea, coffee, aromatic and medicinal plants, and basmati rice.
4. Pathogens and insect populations are strongly dependent upon temperature and humidity, and changes in these parameters may change their population dynamics.
5. Other impacts on agricultural and related sectors include lower yields from dairy cattle and decline in fish breeding, migration, and harvests. Global reports indicate a loss of 10-40% in crop production by 2100. Climate change is expected to impact on agricultural productivity and shifting crop patterns. It

will affect food security, trade policy, livelihood activities and water Conservation issues impacting large portions of the population. Recent IPCC report and a few other global studies indicate a probability of 10 – 40% loss in crop production in India with increase in temperature by 2080 – 2100. The crops grown during the kharif season such as grains, pulses and oilseeds are impacted by both low as well as excess rainfall.

### **Forests and Climate Change:**

Forests play an important role in mitigating climate change but they also are impacted by Climate Change. The Intergovernmental Panel on Climate Change (IPCC) estimates that at least one-third of the world's remaining forests may be adversely affected by changing climate. Impacts include forests becoming dried leading to more and severe forest fires and more vulnerable to pests and diseases. Forests play a critical role in the carbon cycle as they store carbon, and exchange it with the atmosphere through photosynthesis and respiration. Forests play a critical role in protecting the Earth from climate change and regulating climate patterns, as the trees – trunks, branches and roots – and even soil absorb and store CO<sub>2</sub>, providing a natural reservoir for this GHG. In fact, the Earth's vegetation and soils currently contain the equivalent of approximately 7500 Gigatonnes (Gt) of CO<sub>2</sub> – that is more carbon than is contained in all the remaining oil stocks on the planet and more than double the total amount of carbon currently in the atmosphere.

### **Mitigation Technologies:**

**Agriculture:** Improved crop and grazing land management, improved cultivation technologies and livestock and manure management to reduce CH<sub>4</sub> emissions, improved nitrogen fertilizer application techniques, dedicated energy crops to replace fossil fuel use, improved energy efficiency, improvements crop yields.

**Forestry / Forest :** A forestation, Reforestation, Forest management, reduce deforestation, harvested wood products management, carbon sequestration, improved Remote sensing technologies, land-use change

### **National Mission for a Green India:**

Forests are one of the important carbon sink . Prime Minister has announced a green India campaign under which 6 million hectares of land will be turned green. Botanic gardens are playing crucial role in creating sink for Carbon dioxide and Carbon monoxide which are generated by respiration and vehicular exhaust. None the less ruminant's digestion is also adding methane to the atmosphere which is more potent CFC than Carbon dioxide.

India will spearhead efforts at the international level to work towards ecologically sustainable green revolution. This can be achieved through reforestation activities like growing more and more trees to absorb generated carbon dioxide and other CFC gases which can reduce the global warming at some extent and will help the International Community to get rid of bad effects of it.

### **References :-**

1. S. R. Yadav and M.M. Sardesai (2002): Flora of Kolhapur District.
2. S. R. Yadav et.al. (2016): Lead Botanic Garden, Enumeration of Plant Wealth

**Skills for KM in Library and Information Science.****Raghunath R. Chavan**Shri. Vijaysinha Yadav Arts And Science College,  
Peth Vadgaon Dist : Kolhapur**Abstract:**

*This paper describes how to transform the information and generate, store and disseminate to right time to right user in form. So now a day they have more skills such as human, conceptual and communication etc. They also learn how to help people do research and find information. Nowadays, information comes in many forms. Students of library science learn how to organize these different types of information so that library users feel comfortable rather than confused. Students of library science value the past and embrace the future.*

*Key Words: Management, library users, Information Science, Knowledge Management*

**Introduction:**

Library science often termed library studies is an interdisciplinary or multidisciplinary field that applies the practices, perspectives, and tools of management, information technology, education, and other areas to libraries; the collection, organization, preservation, and dissemination of information resources; and the political economy of information.

science programs prepare people to work as librarians or consultants. Students learn to buy, organize, store, and retrieve information.

**The role of library science:**

The role of library science is to provide a combined service of research and teaching. It contributes to the knowledge base of professionals and helps in preparing them to achieve excellence. Library science is one field which has changed tremendously in the past 20 years which makes it more challenging than any other profession. The library science course will help in designing and improving libraries. In the digital age, the importance of librarians and library science is increasing. Library professionals are the one who are completely involved in providing information services to professionals and organizations. In the modern digital age, the need for quality and filtered information has grown up and so librarians have a major role to play. This has increased the scope for library science in this digital age.

**Human Skill:**

Human skill is the manager's ability to work effectively as group members and to build cooperative effort within the team he or she leads. Every managerial level requires interaction with other people, whereas technical skill is primarily concerned with working with things (processes or physical objects). The first level manager is involved on a regular basis with the personal problems and life events of many non-managers. It is therefore natural that he or she must be able to work through these personal situations and effectively lead subordinates. He or she has to perceive and reorganize the perception of his or her superiors, equals and subordinates and his or her own behavior subsequently.

**Conceptual Skill:**

Conceptual skill means the ability to see the organization as a whole and it includes recognizing how the various functions of the organization depend on one another. It also makes the individual aware how changes in any one part of the organization affect all the others. It extends to visualizing the relationship of the individual business to the industry, the community and the political, social and economic forces of the nation as a whole. Thus the manager gains insight into improving the overall welfare of the total organization.

**Communication Skills:**

As a manager (concerned with getting things done) your view of words should be pragmatic rather than philosophical. Thus, words mean not what the dictionary says they do but rather what the speaker intended. Suppose your manager gives to you an instruction which contains an ambiguity which neither of your notice and which results in you producing entirely the wrong product. The greatest source of difficulty is that words often have different meanings depending upon context and/or culture.

**The importance of Library Science:**

Library science comes with many definitions, each one different from the next and the varying forms only lead people to misunderstand its actual value in the world. To put it simply, libraries are very useful for

all of us, either when we are kids in school, students in college, learning something to ace that new job interview or for finding that perfect book to read in our spare time.

### **Changing Roles of Future Academic Library Professional:**

The changing role of library professional implies a set of updated skills needed for facing the challenges created by the latest web technologies in the e-learning environment. The emphasis will shift from technical skills in the library to communication, facilitation, training and management skills. Although technology presents the librarian with ethical challenges, the librarian is to be ready for the role of information professional in the connected networked world and they have to acquire skills that can be contributed to success in their new roles.

### **Conclusion:**

The changing roles of librarians, as facilitated by the use of the Internet, should be of great concern to the profession. There are three major areas, which should be addressed by the information profession to meet the challenges of these changes:

1 Because the Internet provides library users with a vast array of seemingly accurate information, librarians will need to increasingly adopt the role of teacher or guide. Users will not only need to learn how to best access information, they will also need to be taught to critically evaluate Internet resources to determine their validity. Librarians can and will need to provide this guidance.

2 Library professionals will need to address the issues of information organization and retrieval via the Internet. Librarians should remain proactive in dealing with policy and procedural issues concerning organization and access. In this way, the Internet of the information retrieved by library users can be ensured.

### **References:**

1. Ahmed, P. K., Lim, K.K., &Loh, A.Y.E. (2002). Learning through Knowledge Management. Oxford: Butterworth-Heinemann.
2. Alavi, M.&Leidner, D. (1999). Knowledge Management Systems: Issues, Challenges and Benefits. Communications of the Association for Information Systems, Vol. 1, Article 7.
3. Albert, S. ,&Bradley, K. (1997). Managing Knowledge: Experts,Agencies and Organizations. Cambridge, UK: Cambridge University Press.
4. Branin, J.J. (2003). Knowledge Management in Technical Libraries: Building the Knowledge Bank at the Ohio State University. Journal of Library Administration, 39(4):41-56
5. Burton-Jones, A. (1999). Knowledge Capitalism: Business, Work, and Learning in the New Economy. Oxford, UK: Oxford University Press.
6. Trends & Developments. DESIDOC Bulletin of Information Technology 23(5):3-11.
7. Helmstadter, E., (2003). (Ed.). The Economics of Knowledge Sharing: A New Institutional
8. Serban, A.M. & Luan, J. (2002). (Ed.). Knowledge Management: Building a Competitive Advantage in Higher Education. San Francisco: Jossey-Bass.
9. Shukla, A. & Srinivasan, R. (2002). Designing Knowledge Management Architecture: How to Implement Successful Knowledge Management Programs. New Delhi, India: Response Books.
10. Susarla, A., Liu, D, &Whinston, A.B. (2003). Peer-to-Peer Enterprise Knowledge Management. In Handbook on Knowledge Management. Pt. 2: Knowledge Directions, pp 129-139, Berlin: Springer.
11. Stover, M. (2004). Making tacit knowledge explicit: the Ready Reference Database as codified knowledge. Journal: Reference Services Review, 32(2):164-173.
12. Townley, C.T. (2001). Knowledge Management and Technical Libraries. College & Research Libraries, 62(1):44-55.

## Experimental And Fe Analysis For Comparative Bending Stress Analysis Of Cosine Gear And Involute Spur Gear

A.D. Nigade<sup>1</sup>, Dr. P.J. Patil<sup>2</sup>, Dr. A.S. Todkar<sup>3</sup>

<sup>1</sup> Tatyasaheb Kore Institute of Engineering & Technology, P.G. student, Dept. of Mechanical Engineering, Warananagar.

<sup>2</sup> Tatyasaheb Kore Institute of Engineering & Technology, Faculty of Mechanical Engineering, Warananagar,

<sup>3</sup> Tatyasaheb Kore Institute of Engineering & Technology, Faculty and Head Dept. of Mechanical Engineering, Warananagar.

### Abstract:

The increasing demand for quite power transmission in machines, vehicles and generators has created a growing demand for a more precise analysis of the characteristics of gear systems. In addition, the success in gear noise reduction promotes the production of quieter gear pairs for further noise reduction. This study focuses on analysis and evaluation of cosine gear from stress perspective. Cosine gear prototype is manufactured with EDM wire cut process. Bending stresses at root of tooth are studied for involute and cosine gear of same specification. Stress analysis is conducted using Finite element method and experimentally verified with the strain gauge method. Bending stress at root of tooth of cosine gear is found to be less than involute profile gear.

**Key words:** Cosine gear, Involute gear, Strain gauge

### Introduction

Basic gear design includes tooth force analysis, bending stress calculation etc. which are functions of tooth profile. A tooth profile is the geometry of a tooth; which determines kinematic and dynamic properties of a gear drive. It is the fundamental thing that directly relates to design parameters and ultimately current market requirements like strength, Transmission performance, life, quietness in operation. Some of the commonly used gear teeth profiles are involute, cycloid, epicycloids, and hypocycloid. Most commonly used among them is involute because of simplicity in manufacturing. Different approaches used for profile modification are as changing root fillet shape from trochoidal to circular, profile shifting, face crowning, changing the pressure angle and combining different profile modification techniques. FEA and strain gauge analysis techniques are used effectively to study the stresses. There is need to analyze the cosine gears for stress characteristics using FEA & Experimental method. Bending stress evaluation in modern gear design is generally based on Lewis equation. Lewis equation do not provide a reliable solution to the wide variety of non-standard gear tooth profiles that could be considered. . Hence FEA and Strain gauge analysis can be used to analyze non standard gear tooth profiles.

### Generation of cosine gear:

The cosine tooth profile is presented by Shanming Luo, Yue Wub, Jian Wang[1].The cosine gear is generated using the following method-

1. The zero line of cosine curve is taken as the pitch circle.
2. Period of curve is taken as tooth space.
3. The amplitude of curve as tooth addendum.

The equation of cosine tooth profile is given as,

$$p = r_1 + h \cos (Z_1 \theta)$$

p= Polar co-ordinate of pt M

h= Addendum of cosine gear

r<sub>1</sub>= Radius of pitch circle of cosine gear

Z<sub>1</sub>=No of teeth

θ =Angle between the position vector of pt M & Y axis.

### Specifications:

Pinion

Gear

Module= 3mm

Module= 3mm

No of teeth=28

No of teeth=42

Face width=25mm

Face width= 25mm

Three different cases of working conditions as mentioned below in Table.1. are considered

Table.1. Working Parameters

Case	Power (KW)	Speed (N)
I	1	500
II	1	600
III	1	700

### Theoretical Analysis

Lewis equation is developed by Wilfred Lewis (1892) is still used as base for bending stress analysis of involute gear tooth (Bhandari 2007). Theoretical analysis of involute gear tooth is carried out by Lewis equation & results obtained are tabulated in Table 2.

### Finite Element Analysis

This section represents Finite Element Analysis of both involute & cosine gear drive.

Procedure of FE Analysis:

- Gears have been modeled in CATIA V5 software.
- Geometry has been imported in ANSYS Workbench14.5.
- Assigning the material properties and element type (solid 187): 8 node isoparametric element.
- Meshing of gears: Fig.1. & fig.2. shows meshing of cosine gear & involute gear pairs respectively.

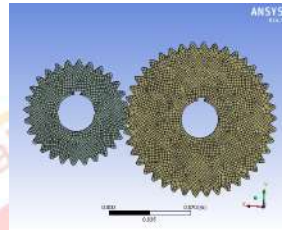

Fig.1. Meshing of cosine gear

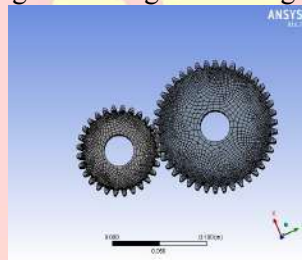

Fig.2. Meshing of involute gear

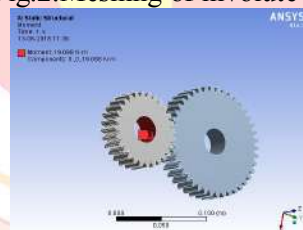

Fig.3. Moment applied to pinion



Fig.4. Fix support to gear

Solution: The problem is well defined in preprocessor. This problem is then solved using ANSYS solver.

Postprocessing: The von-mises stress distribution at root of tooth of cosine gear & involute gear were shown in fig.5 & fig.6 respectively.

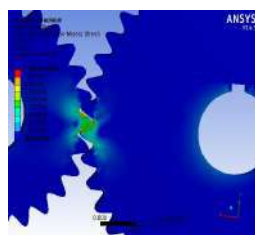



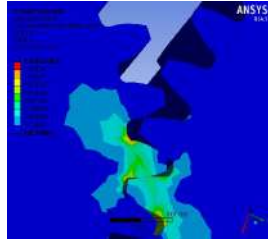

Fig.5. Bending stress at root of tooth of cosine gear

Fig.6. Bending stress at root of tooth of involute gear

### Strain Gauge Analysis:

While there are several methods of measuring strain, the most common is with a strain gauge. It is a device whose electrical resistance varies in proportion to the amount of strain in the element. The most widely used gauge is the bonded metallic strain gauge. Experimental analysis was carried out using electrical resistance strain gauge as follows:

- Manufacturing of cosine gear by EDM wire cut method.
- Design and development of loading frame:

As gears are used to transmit torque, the loading frame has to be prepared which will simulate the actual running conditions. For this, the loading frame was designed & fabricated as shown in fig.7.



Fig.7. Loading frame

- Selection of strain gauge:

The strain gauge model and gauge length were selected which met the requirements of the measuring object & purpose. Considering the material of gear and type of strain developed in gear tooth, FLA-3-350-11 type strain gauge was selected.

**Bonding of strain gauge:** Accurate strain measurement requires a mirror like surface to bond the strain gauges on it. So, the gear surface at root of the tooth which was in tension prepared using polish paper. Then the surfaces were washed with the help of alcohol & acetone

After preparing the surface at root of tooth, strain gauges were bonded on the prepared surface with the help of adhesive cyano-acrylic by following standard procedure, as shown in figure. The correctness of strain gauge mounting was checked by measuring the resistance of strain gauge ( $350\Omega$ ) with the help of multimeter.



Fig.8. Bonding of strain gauge

**Measurement of strain:**

The prepared gauges were mounted on the loading frame and torque was applied on it, as shown in figure 9. Finally, the induced strain at root of gear tooth was recorded with the help of Dew software.



Fig.9. Experimental Setup

4. Calculations: The Following calculations were done to get bending stress.

**a) For Cosine gear**

For 3 Kg load,

$$\text{Torque} = m \times g \times L$$

Where, m=load in Kg=3Kg

L=Length of rod=100mm

g=Acceleration due to gravity

$$\begin{aligned} \text{Torque} &= 3 \times 9.81 \times 100 \\ &= 2943 \text{ N-mm} \end{aligned}$$

For applied torque of 2943 N-mm strain developed in gear is  $10 \times 10^{-6}$ .

Therefore, for torque of 19098.59 N-mm,

strain developed in gear,

$$\epsilon = \frac{19098.59}{2943} \times 10 \times 10^{-6}$$

$$\epsilon = 64.89 \times 10^{-6}$$

As per Hook's law,

Modulus of Elasticity,

$$E = \frac{\text{Stress}}{\text{strain}}$$

$$2.1 \times 10^5 = \frac{\sigma_b}{64.89 \times 10^{-6}}$$

Where,  $\sigma_b$  = Bending stress at root of tooth

$$\sigma_b = 64.89 \times 0.21$$

$$\sigma_b = 13.627 \text{ N/mm}^2$$

Hence, For torque of 19098.59 N-mm stress developed at root of tooth of gear is  $13.627 \text{ N/mm}^2$ .

**b) For Involute gear**

For applied torque of 2943 N-mm strain developed in gear is  $13 \times 10^{-6}$ .

Similar procedure has been carried out for involute spur gear & results are tabulated in table 2.

*Table.2. Comparative results of theoretical, Finite Element Analysis & experimental analysis of involute gear and cosine gear*

		Theoretical analysis	Finite analysis	Element	Experimental	Analysis
Case	Torque (N-mm)	Max. bending stress in involute gear (N/mm <sup>2</sup> )	Max bending stress in cosine gear (N/mm <sup>2</sup> )	Max bending stress in involute gear (N/mm <sup>2</sup> )	Max bending stress in cosine gear (N/mm <sup>2</sup> )	Max bending stress in involute gear (N/mm <sup>2</sup> )
I	19098.59	17.224	11.60	15.550	13.627	17.72
II	15915.49	14.35	9.669	13.48	11.3566	14.76
III	13641.85	12.303	8.228	10.438	9.73	12.654

**Conclusion:**

In this dissertation work experimental and finite element analysis for evaluation of bending stress at root of the tooth of involute gear and cosine gear is carried out. There is fairly good agreement between experimental & FEA methods. Following conclusions have drawn from this study

- The percentage difference observed between bending stress at root of tooth of cosine gear & involute gear by FEA method is 25%.  
The percentage difference observed between bending stress at root of tooth of cosine gear and involute gear by strain gauge method is 23%
- The percentage difference observed between bending stress at root of tooth of cosine gear & involute gear by FEA method is 24%.
- Strain gauge analysis is best suitable for experimental analysis of spur gear.
- Bending stress observed in cosine gear is less than involute gear.

**References:**

1. Shanming Luo, Yue Wub, Jian Wang, "The generation principle and mathematical models of a novel cosine gear drive", Mechanism and Machine Theory - 43, Elsevier, pp 1543–1556, 2008.

2. Naresh K. Raghuwanshi, Anand Parey, “Experimental measurement of gear mesh stiffness of cracked spur gear by strain gauge technique” , Measurement 86 (2016) 266–275,Elsevier.
1. Toni Jabbour, Ghazi Asmar, “Tooth stress calculation of metal spur and helical gears”, Mechanism and machine theory, 92 (2015), 375–390, Elsevier.
3. Praveen Silori, Amir Shaikh, Nithin Kumar KC, Tushar Tandon, “Finite Element Analysis of Traction gear using ANSYS”, Materials Today: Proceedings 2 (2015) 2236 – 2245, Elsevier.
4. Xiang Dai, Christopher G. Cooley, Robert G. Parkera, “Dynamic tooth root strains and experimental correlations in spur gear pairs”, Mechanism and machine theory, Elsevier



**“Studies on Insect Biocontrol Agents from Kolhapur districts of Western Maharashtra, India”****A. R. Bhusnar & P.M. Bhoje**Department of Zoology, Yashwantarao Chavan Warana,  
Mahavidyalaya, Warananagar.**Abstract**

*Organic pest control is a method that utilizes natural resource to control different kinds of pests, primarily various insect species that destroy vegetation. This method helps to protection of environment and conservation of biodiversity. Biocontrol agents have been collected from Kolhapur region, during August. 2016 to July 2017 by using insect collecting net and hand peaking at 7 days interval during morning and evening hours further they utilized for observation made regarding biocontrol potential and taxonomical features. Total 11 effective biocontrol agents are reported from Kolhapur region. All these insects are highly useful and well adapted in climatic condition Kolhapur region. These are reported as effective biocontrol agents of various agriculture crop pests.*

**Key words:** Biocontrol, Insect, Pests, Kolhapur.

**Introduction**

Biological control is very good alternative for chemical since chemical control leads several serious problems such as pollution, killing of beneficial organisms, pest resistance, pest resurgence, secondary pest outbreak, interruption to ecocycles, etc. The use of certain insects to attack and destroy pests predominantly to other insect pests is an exciting and gradually more popular natural method of biological insect control. Insects are unwelcomed guests in our crop field and in garden as they infuriating, but some of them are beneficial as pollinator, food ingredients producer like honey, while others are enemies within themselves. If we widely use them to control crop pests it would be great step to conserve and protect our precious environment. We all know that the indiscriminate use of chemical pesticides leads to problems to health and wealth also. This has been proven that chemical pesticides get accumulate under the integument and it is a main reason to develop cancer in all kinds of animals.

Organic pest control is known to be a method that utilizes natural resource in order to be able to control different kinds of pests, primarily various insect species that destroy vegetation. This method helps to protection of environment and conservation of biodiversity. Bio-control of pest insects is one of them, this method is popular method. In this method pest has controlled by using natural enemies. Some natural enemies are reported and shortly described below. Following are some common but effective natural enemies of insects found in Kolhapur and its periphery region.

**Materials and Methods**

Biocontrol agents have been collected from Kolhapur region, during August. 2016 to July 2017 by using insect collecting net and hand peaking at 7 days interval during morning and evening hours. For identification, observation have been made on taxonomical features with the help of compound microscope and hand lens and photographed with the help camera cannon Company. Some species of insect pests were reared in laboratory for lifecycle studies. Identification of insect pests was made up consulting literature by Baker (1987), Baker & Cook (1974) Beirner (1967) Cook and Baker (1983) Cook and Weller (1987) Costa and Muller (1980) De Bach (1964) Waage and Greathead (1988).

**Results****1) Dragonfly (Fig. 1) (Odonata-Libellidae) *Crocothemis spp.***

Dragonflies developing in aquatic ecosystem have tremendous importance in biological control of insect pests such as mosquitoes, jassids, midges and several kinds of moth in agro and forest ecosystems.

Odonates are commonly found darting and dancing actively near ponds, pools, rivers, streams and also marshy place. Some species of Odonata are also reported on trees and shrubs, water ponds and in dense forests. They are reported from sea levels to over 3, 600 m and from brakish marshy areas to desert lands from all over the world.

*Crocothemis servilia servilia* (Drury) (Odonata: Libellulidae) is abundant biocontrol agent of paddy pests in Warana region of Maharashtra. It predate on paddy jassid *Nilaparvata sp.*, Paddy borer *Chilo suppressalis* (Walker) and Jowar stem a borer *Chilo partellus* (Swin). *C. servilia servilia* completes its life cycle within 3 months, egg stage lasts for 18 days and nymphal period is 72 days. There are 12 instars, each has about 7 – 10 days duration. During nymphal period they feed on paramoecium, daphnia, redworms and mosquito larvae. Adult survives for 4 days without food. Mated female can lay about 140 – 150 eggs in water body/water trough.

The dragonfly genera *Crocothemis*, *Pantala*, *Bradinopyga*, *Brachythemis*, *Tramea*, *Sympetrum* and *Czocontenemis* are associated with mosquito larvae for feeding and are effective biocontrol agents of *Culex quinquefasciatus*, *Anopheles sinensis* and *Aedes aegypti*.

## 2) Praying mantis (Fig.2)- ( Mantoidea: Mantidae), *Archimantis. spp.*

The praying mantis is named for its prominent front legs, which are bent and held together at an angle that suggests the position of prayer. They have triangular heads poised on a long neck, or elongated thorax. Mantis can turn their heads 180 degrees to scan their surroundings with two large compound eyes and three other simple eyes located between them.

Typically green or brown and well camouflaged on the plants among which they live. Their legs are further equipped with sharp spikes for capturing prey and pinning it in place. Moths, crickets, grasshoppers, flies, and other insects are usually the unfortunate recipients of unnecessary mantis attention. However, the insects will also eat others of their own kind. The most famous example of this is the typical mating behavior of the adult female, who sometimes eats her mate just after or even during mating. Females lay approximately hundreds of eggs in Oothica, and newly hatched nymphs look tiny, versions of their parents.

## 3) Mud wasp (Fig.3)- ( Hymenoptera:Waspidae) *Eumenes spp.*

Mud wasps undergo complete metamorphosis, They are solitary insects even though in some suitable habitats more than one mud nest will be found. The shape and size of mud nests helps identify different groups of mud wasp. Single nest found group of cells that are cylinder in shape and covered with mud, hence it appears to be a smooth. Mud nest about 2 inches wide and about 4 inches long. While mud wasp makes new nests for each generation, a few species will reuse old mud nests constructed in previous generation, wasp complete one or two generations in year, In the spring, the pupae develop into adults. The new adult females begin building a new nest. After completing nest, they start to capture insects or spiders that are placed into each mud nest cell. Eggs are deposited on the prey within each cell, and the cell sealed with mud. The larvae that hatch from the eggs feed on the prey left by the adult wasp, and then change into the pupal stage that overwinters. Prey are stung and paralyzed, not killed, before being placed in the mud cell. This skill helps to make food fresh and avoid decomposition. In spring, the pupae become adults, thus beginning the next generation of mud wasp. Adults feed on plant nectar, honeydew and the body fluids of the spiders and insects they capture.

## 4) Ichneumon fly (Fig.4) ( Hymenoptera: Ichneumonidae) *Therion spp.*

The ichneumon wasp is employed by the nature to control pest populations of crop-damaging beetles, butterflies, moths, and other hymenopterans (members of the insect order Hymenoptera). The ichneumon wasp is a parasitoid: Its parasitic larvae feed on or inside another insect host species until it dies. Because many of the hosts of the ichneumon larvae are insect pests of both agricultural and forest crops, ichneumons can be effective biological control agents and provide an economic and environmental benefit to humans.

Ichneumons, which belong to the Ichneumonidae family of insects, are slender, medium- to large-sized wasps, comprising more than 60,000 (possibly up to 100,000) species worldwide. The vast majority are stingless and endangers to humans. Females have a permanently extruded ovipositor, a needlelike appendage at the tip of the abdomen that is extremely long in many species. They use this ovipositor to deposit eggs into or onto a host, usually while the immature insect host is a larva or pupa. The eggs then hatch and develop into ichneumon larvae that slowly consume their host. Eventually, they kill the host and emerge as mature parasitoids.

## 5) Braconid fly (Fig.5) (Hymenoptera: Braconidae.) *Apanteles spp.*

The braconid family is in the Order Hymenoptera, which includes other bees and wasps, but all 1,700 North American species in this family are stingless, and so small you have to pay close attention to observe

them. They can be almost invisible, at 2 to 3 millimeters long or veritable giants at 15 millimeters. They are control several lepidopteron pests by their parasitized behavior, single mated female lay near about 40-50 eggs inside the body of host larva at 2 instar stage. Incubation occurred within 3 days after oviposition. The eggs averaged 0.160mm in length and 0.48mm in width. The parasitoid showed three larval instars. First instar was with broad quadrate head, and with 3 thoracic and 7 abdominal segments. First instar was characterized by vesicle at the posterior end. This stage lasted for 3 days. Second instar was cylindrical, straight, with head, thorax and abdomen indistinctly cleared. Third instar was opaque coloured and was typically hymenopteriform. The larva tapered slightly towards both the ends. Cocoon was cylindrical and rounded at both the ends and was with silken threads.

#### 6) Tachinid fly (Fig.6) (Diptera : Tachinidae) *Thelaira spp.*

Tachinids parasitize other insects. They may glue their eggs to their host or lay their eggs on foliage where the host larvae will eat them. Some have ovipositors with which they inject their eggs directly into the unwary host's body. Extremely beneficial because of their diversity, tachinids also can be much appreciated due to their small size and unnoticed activities. They help control garden pests such as gypsy moths, cabbage loppers, Japanese beetles, armyworms, cutworms, sawflies, codling moths, peach twig borers, pink bollworms, tent caterpillars, squash bugs and many more. Egg and larvae developed quickly in tachinid flies. Many species pass from the early stages to adulthood in just three to four weeks. If the host also moves through life stages quickly, several generations can be produced in year. A larva has formed inside the host, it maintains respiration by either attaching its posterior end to its victim's tracheal system or leaving that end protruding from the hosts body.

#### 7) Robber fly (Fig.7) (Diptera: Asilidae) *Smeringotus spp.*

Robber Fly, any of a family of medium to large predatory flies known for their quick flight, super vision, and their special habit of catching large prey during in flight. Also called killer flies, they are widely distributed. Robber flies are highly variable in size and body shape, ranging from 0.5 to 5.0 in length. Most species are slender-bodied, with arched backs and tapering abdomens; but some are stout-bodied and hairy, with rounded abdomens, resembling bees. They have large eyes that face toward the sides, and the top of the head is typically concave between the eyes.

Robber flies are impressive predators that typically specialize in flying insects, including wasps, bees, and dragonflies; the prey may be larger than the robber fly itself. Most robber flies frequent sunny, open areas and are active during the warmest parts of the day and year. They settle on branches, wood, stones, or the ground, and rush out to attack when suitable prey flies. The robber fly uses its bristly legs to catch the prey by grasping it around the head or back. Then, employing its needlelike mouthparts, the robber fly stabs the prey and injects saliva that contains nerve toxins and digestive enzymes. This quickly paralyzes the prey and liquefies its tissues; the robber fly then sucks out the prey's insides, much as spiders do. The larvae, or immature stages, of robber flies are wormlike predators. They live in soil, rotting stumps and logs, and similar moist organic material. Larval robber flies live solitarily and in secluded places, so their ecology and habits are less well known than are those of the adults. The larvae feed primarily on the eggs and larvae of other insects, including beetles, grasshoppers, and flies.

#### 8) Ant lion (Fig.8) (Neuroptera: Myrmeleontidae) *Palpares spp.*

The Antlions are a group of about 2,000 species of insects in the family Myrmeleontidae, known for the predatory larva's habit of digging a pit and trapping passing ants. The less remarkable adults are sometimes called ant lion lacewings.

A fully grown, well-nourished larva is up to 1.2 cm long, while adults are up to 4 cm long. Antlions are worldwide in distribution, most commonly occurring in dry and sandy region. Antlions can be fairly small to very large Neuropterans, with wingspans ranging from 2 to 15 cm (0.8 to 5.9 in). The adult has two pairs of long, narrow, multi veined wings in which the apical veins enclose regular oblong spaces, and a long, slender abdomen. Although they somewhat resemble dragonflies or damselflies, they belong to a different infraclass of winged insects. Antlion adults are easily distinguished from damselflies by their prominent, apical clubbed antennae which are about as long as the head and thorax combined. Compared to damselflies, they are very weak fliers and are normally found fluttering about at night in search of a mate. The adult is rarely seen by day but is typically active at dusk and after dark.

The abdomen in males is usually longer than in females and often has a post-ventral lobe. The tip of the abdomen of females shows greater variation than that of males, depending perhaps on ovoposition sites, and usually bears tufts of bristles for digging. The adult is considerably larger than the larva; they exhibit the greatest disparity in size between larva and adult of any type of holometabolous insect. Exoskeleton of the adults is extremely thin. The adult typically lives for about 25 days, but sometimes survives for as long as 45 days.

### 9) Lady bird beetle.( Fig.9) ( Coleoptera: Coccinellidae) *Coccinella spp.*

Coccinellids are found worldwide, with over 5,000 species. Most species are carnivorous. Their favorite food is pests such as aphids or scale insects. Their larvae are also voracious eaters of aphid. Most coccinellids over winter as adults. It only takes about four weeks for the ladybeetle to transform from a tiny egg to an adult. Some females can lay up to 1,000 eggs in one summer. The ladybeetle may lay her eggs near an aphid colony, or on plants where the larvae will have a ready supply of food when they hatch, eggs hatch in 3 to 4 days from clutches numbering from a few to several dozen. Depending on the supply of aphids, the larvae pass through four instars over 10–14 days, after which pupation occurs. After some days, the adults become reproductively active and are able to reproduce again, though not late in the season. Total life span is 1–2 years on average.

Almost all lady beetles are insectivores: they eat other insects. Many of these insects have soft bodies, such as aphids. Even the larvae eat other insects. Aphids are a enormous problem for farmers and gardeners, and therefore a ladybug is a great help to the farmer. Some species of ants herd aphids like sheep, and will attack a ladybeetle that tries to eat one of their aphids.

### 10) Lace wing (Fig.10 &11) (Neuroptera:Chrysopidae) *Chrysoperla spp.*

The lacewings (Order-Neuroptera) are very potential biocontrol agents of several insect pests of agriculture, forest and agricultural ecosystems. They predate upon eggs, nymphs and larvae of hemipterous and lepidopterous pests and cause the mortalities. Therefore they are widely used in the Biological pest control. The common green lacewing (*Chrysoperla rufilabris*) is a widely used, which naturally controls many different pests. Actually, most species of the adult lacewing do not kill other insects but survive on pollen, sweet nectar, etc. It is their offspring or lacewing larvae that do the job. The adult lacewing lays her eggs on the foliage, each on top of hair-like filaments. After some days the eggs are hatch and a tiny larva emerges which is also known as the “aphid lion” because of its voracious feeding.

Lacewing larvae are similar in appearance sharp forceps like mouth parts, they attain strongly attacks on prey, injecting a paralyzing venom then drawing out the body fluids of its victim. Besides aphids, they feed on just about any soft-bodied pest they can grab. including citrus mealybugs, cottony cushion scale, spider mites, thrips, caterpillars, insect eggs, etc. within two to three weeks it will consume up to 500 individuals. After this, it will pupate by spinning a cocoon with silken thread. There are five or six overlapping generations each season.

### 11) Long Horned grasshopper (Fig.12) (Orthopte: Tettigoniidae) *Euconocephalu spp.*

Long horned grasshoppers are characterized by having antennae long with numerous segments, long sword or sickle shaped ovipositor and hind femora long narrow towards the tip. Maximum members of tettigoniidae are active at night. Stridulatory mechanism mostly used for attracting the female for mating and warning to other animal when their are in danger. Stridulatory mechanism in tettigoniidae mostly carried out at night. Auditory organ present near the base of fore leg tibia.

The family Tettigoniidae is a heterogeneous group of grasshoppers with more than 1120 recognized genera and 6800 species and is the largest family within the Orthoptera. Members of Tettigoniidae lay eggs on the plant stems or ventral side of plant leaves in groups, mostly in post monsoon period, and maximum long horned grasshoppers hatched in monsoon season. Newly emerged nymphs of grasshopper feed on the developing barks, grain ovaries, flowers, small insects etc. They moult 7-8times.

## Conclusions

Total 11 effective biocontrol agents are reported from Kolhapur region. All these insects are highly useful and well adapted in climatic condition Kolhapur region. These are reported as effective biocontrol agents against of various agriculture crop pests. These biocontrol agents control naturally agricultural pests

and maintain the pest population below economic level. It is effective eco-friendly, pollution free and natural method.

## References

1. Baker, K. F. 1987. Evolving concepts of biological control of plant pathogens. *Ann. Rev. Phytopathol.* 25:67-85.
2. Baker, K. F., and R. J. Cook. 1974. *Biological Control of Plant Pathogens*, W. H. Freeman and Co, San Francisco, California. 433 pp. (Book, reprinted in 1982, Amer. Phytopathol. Soc., St. Paul, Minnesota).
3. Beirner, B. P. 1967. Biological control and its potential. *World Rev. Pest Control* 6(1):7-20.
4. Brodeur, J., Cory, J., Harwood, J.D., Hoffmann J.H., Jacobsen, B. Lewis, E.E., Ode, P., Te Beest, D. O., and S.B. Vinson, (2013). *Biological Control* Editorial Board. Elsevier Journal website. Copyright © 2013 Elsevier B.V
5. Cook, R. J., and K. F. Baker. 1983. *The Nature and Practice of Biological Control of Plant Pathogens*. Amer. Phytopathol. Soc., St. Paul, Minnesota. 539 pp.
6. Cook, R. J., and D. M. Weller. 1987. Management of take-all in consecutive crops of wheat or barley. In I. Chet (ed.). *Innovative Approaches to Plant Disease Control*. John Wiley & Sons, Inc. pp. 41-76.
7. Costa, A. S., and G. W. Muller. 1980. Tristeza control by cross protection: A U.S.-Brazil cooperative success. *Plant Disease* 64:538-541.
8. De Bach, P., ed. 1964. *Biological Control of Insect Pests and Weeds*. Reinhold, New York, New York. 844 pp.
9. Dreistadt, S. H. 2007. *Biological control and Natural enemies*. UC Statewide IPM Program, Davis. Produced by UC Statewide IPM Program, University of California, Davis
10. Waage, J., and D. J. Greathead. 1988. Biological control: challenges and opportunities. In R. K. S. Wood and M. J. Way (eds.). *Biological Control of Pests, Pathogens, and Weeds: Developments and Prospects*. The Royal Soc., London., pp 1-18.

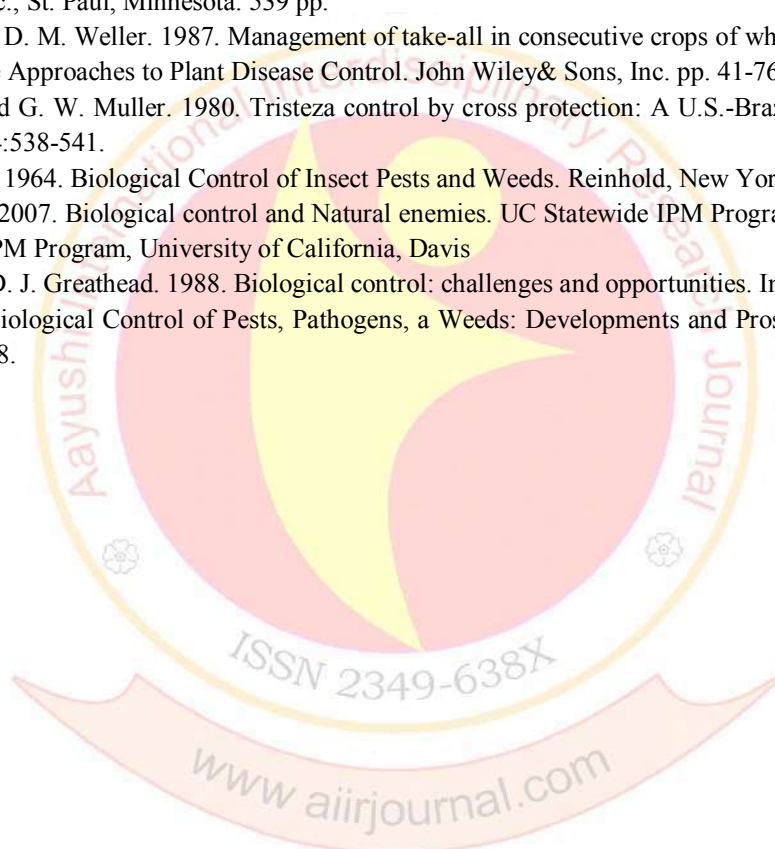



**Effect Of Seaweed Liquid Fertilizer Of *Caulerpa Taxifolia* On Pigment Concentration Of Fenugreek****Bharat Misal**Krantisinh Nana Patil College, Walwa,  
Dist- Sangli, Maharashtra, India 416313**Abstract:-**

Investigations were made to find out the effect of seaweed liquid fertilizer (SLF) prepared from green alga *Caulerpa taxifolia* on pigment content in fenugreek (*Trigonella foenum –graecum*). The crop plants were sprayed with different concentrations (5%, 15%, 30%, 50%, 70% and 100) of SLF. Maximum amount of chlorophylls was recorded at plants sprayed with 30% SLF prepared from fresh material and plants sprayed with 15% SLF prepared from dry material of *Caulerpa taxifolia*. Maximum content of carotenoids were recorded at 30% SLF. Decrease in chlorophyll and carotenoid content was recorded at higher concentrations of SLF.

**Key words:-** liquid fertilizer, *Caulerpa taxifolia*, fenugreek, chlorophylls, carotenoids

**Introduction:**

Seaweeds are biodegradable, non-toxic, non-polluting, Non-Hazardous to humans, animals and birds (Dhargalkar and Pereria, 2005). Application of seaweed liquid fertilizer to crops has been found to increase seed germination, yield of crops, and resistance to frost, fungal attack and uptake of the inorganic nutrients from the soil (Bhosale et al., 1990; Venkataraman et al., 1993; Mohan et al., 1994 and Sekar et al., 1995). In the present investigation an attempt has been made to study the influence of seaweed liquid fertilizer prepared from green alga *C. taxifolia* on seed germination and seedling growth of different crop plants.

**Materials and Methods:-****Materials**

*Caulerpa taxifolia* and fenugreek plants.

**Methods:-****Preparation of seaweed liquid fertilizer:**

Seaweed liquid fertilizer (SLF) was prepared using the fresh as well as dried material of *Caulerpa taxifolia* as described below.

**Preparation of SLF from fresh *Caulerpa*:**

Fresh SLF was prepared following the method given by Bhosale et al. (1975). One kg of fresh seaweed was cut into small pieces and boiled with one litre of distilled water for an hour and filtered through a double layered muslin cloth. The filtrate thus obtained was considered as 100% seaweed liquid fertilizer. From this extract SLF of desired concentration (5, 15, 30, 50 and 70%) was prepared by adding proper quantity of distilled water.

**Preparation of SLF from dried *Caulerpa*:**

This method is described by Rama Rao (1990). Dry powder of seaweed was mixed with distilled water in the ratio of 1:20 (W/V). The mixture was autoclaved at 121°C and 15lbs for 20 minutes. The hot extract was filtered through a double layered muslin cloth and allowed to cool at 4° C. The filtrate was centrifuged at 5000 rpm for 15 minutes. The supernatant was collected and considered as 100% seaweed liquid fertilizer. This SLF was diluted by adding proper quantity of distilled water to get desired concentration.

**Biochemical Analysis: -****Photosynthetic pigments:****Chlorophylls**

Chlorophylls were estimated from fresh harvested plant material following the method of Arnon (1949). Randomly sampled leaves (0.250g) were homogenized and extracted in 80% chilled acetone containing 4 ml ammonia per litre. A pinch of magnesium carbonate was added to neutralize the acids released during extraction. The extract was filtered through Whatman No.1 filter paper using Buchner funnel under suction. Final volume of the filtrate was made to 25 ml with 80% acetone. The filtrate was transferred into a conical flask wrapped with a black paper to prevent photo-oxidation of pigments. Absorbance was read at 663 nm and 645 nm on a double beam spectrophotometer (Shimadzu) using 80% acetone as a blank. Chlorophyll 'a' chlorophyll 'b' and total chlorophylls were calculated using the following formulae-

for chlorophyll 'a'  $X = (12.7 \times A663) - (2.69 \times A645)$

for chlorophyll 'b'  $Y = (22.9 \times A645) - (4.68 \times A663)$

for total chlorophylls  $Z = (8.02 \times A663) + (20.20 \times A645)$

chl a/ chl b /Total chlorophylls =  $X/Y/Z \times \text{volume of extract} \times 100 / 1000 \times \text{weight of plant material (g)}$   
(mg100<sup>-1</sup>g fresh weight)

#### Carotenoids:

Carotenoids were estimated from the same acetone extract prepared for chlorophylls, as per the method described by Kirk and Allen (1965). The absorbance was recorded at 480nm on a double beam spectrophotometer (Shimadzu). The amount was calculated using following formula-

Total carotenoids =  $A_{480} \times \text{vol of plant extract} \times 10 \times 100 / 2500 \times \text{weight of plant material (g)}$

(mg 100<sup>-1</sup> g fresh weight)

#### Results and Discussion:-

##### Photosynthetic pigments:

##### Chlorophylls

Influence of foliar spray of *C. taxifolia* on chlorophyll content in *Trigonella foenum-graecum* is depicted in Table 18. It was evident that the chlorophyll content of leaves of *T. foenum-graecum* treated with SLF prepared from fresh material of *C. taxifolia*, increased with the concentration up to 50%SLF. Maximum amount of chlorophyll a (151.37mg100<sup>-1</sup>g), chlorophyll b (54.38mg 100<sup>-1</sup>g) and total chlorophylls (204.53 mg 100<sup>-1</sup>g) was recorded in plants treated with 30% SLF concentration. At 70% concentration and above the chlorophyll content was declined.

**Table 1. Effect of SLF of *Caulerpa taxifolia* on photosynthetic pigments in *Trigonella foenum-graecum***

SLF (%)	SLF Fresh			SLF Dry		
	Chl. a	Chl.b	Total chlorophylls	Chl. a	Chl.b	Total chlorophylls
Control	98.04	38.58	136.56	99.45	41.78	141.23
5	141.64	51.13	192.71	106.24	43.16	149.40
15	148.16	53.23	201.39	141.82	51.32	193.14
30	151.37	54.38	204.53	132.54	48.87	181.41
50	120.14	41.70	161.84	11.64	43.49	155.13
70	86.00	31.59	117.67	78.42	27.25	105.67
100	73.80	24.93	98.73	68.32	24.72	93.04

Values are expressed in mg100<sup>-1</sup> gm fresh weight

Similar trend was noticed in plants treated with SLF prepared from dry material of *C. taxifolia*. Maximum amount of chlorophyll was recorded in those plants which received 15% SLF. The value recorded at this concentration for total chlorophyll was 193.14 mg.100<sup>-1</sup>g which was less than that for fresh material of *C.taxifolia*.

#### Carotenoids:

The influence of SLF of *C. taxifolia* on carotenoid content in *Trigonella* is represented in the Tables 2.

**Table 2. Effect of SLF of *Caulerpa taxifolia* on carotenoid content in *Trigonella foenum-graecum***

SLF (%)	<i>C. taxifolia</i>	
	Fresh	Dry
Control	30.44	29.68
5	36.16	35.22
15	36.64	36.19
30	38.56	38.48
50	25.08	32.42
70	42.44	25.12
100	22.40	20.79

Values are expressed in mg100<sup>-1</sup> gm fresh weight

The carotenoid content increased up to 30% in *T. foenum-graecum* plants treated with SLF prepared from fresh material of the seaweed. The plants which were treated with SLF prepared from dry material of

seaweeds also exhibited increase in carotenoid content upto 30% SLF level. The carotenoid content at 70 and 100% SLF of the seaweeds was found reduced when compared to the control plants.

A positive effect of SLF on photosynthetic pigments has been reported by different workers. Selvam and Sivakumar (2013) studied the effect of SLF of *Ulvareticulata* on pigments in *Vignaradiata*. They reported an increase in chlorophyll 'a', chlorophyll 'b' and total chlorophyll content in treated plants up to 8% SLF. Babu and Rengasamy (2012) reported increase in chlorophyll content in groundnut, paddy and chilli after treating the plants with SLF of *Kappaphycusalvarezii*. Sujatha and Ramamoorthy (2011) recorded an increase in total chlorophyll content of *Cajanuscajan* when plants were sprayed with SLF of *Sargassum* and *Turbinaria* at lower concentration. Similarly Akila and Jeyadoss (2010) reported increase in content of chlorophylls and carotenoids in *Helianthus annuus* at 2.5 and 5% of *S. wightii*. Kumareswari and Rani (2015) also observed increase in content of total chlorophylls and carotenoids in *Amaranthus caudatus* over control when the SLF of seaweeds *Padinapavonica*, *P. tetrastromatica* and *Stoechospermum* was applied to soil. Pise (2009) reported an increase in chlorophylls and carotenoids in Fenugreek using fresh, boiled and soaked extracts of *Sargassumillicifolium*, *Gracilariacorticata* and *Ulva fasciata*. Many workers have analyzed the effect of SLF after giving seed treatment. Balamurugan and Sasikumar (2013) studied the effects of *Caulerpa scalpeliformis* on pigment content in *Abelmoschusesculentus* and reported the increase in the content of chlorophyll and carotenoids upto 50% SLF level and decline was recorded at 75 and 100% SLF. Similarly Kalaivanan et al. (2012) observed stimulating effect of SLF of *C. scalpeliformis* in *Vignamungoan* increase in chlorophylls and carotenoids at lower concentration and decrease at high concentration was noticed. Positive effects of SLF of *C. peltata* and *Gracilariadura* on photosynthetic pigments in *Vignaradiata* have been discussed by Paul and Mahadevi (2014) and ShriDevi and Paul (2014).

#### Conclusion:-

The concentration of photosynthetic pigments increases in treated plants as compared to control plants. The SLF prepared from fresh material is more effective than SLF prepared from dry material of the alga.

#### References:-

1. Akila, N. and Jeyadoss, T. 2010. The potential of seaweed liquid fertilizer on the growth and antioxidant enhancement of *Helianthus annuus* L. *Oriental J. of Chem.*, 26(4):1353-1360.
2. Arnon, D. I. 1949. Copper enzymes in isolated chloroplast, polyphenol oxidase in *Beta vulgaris*. *Plant physiol.*, 2:1-15.
3. Babu, S. and Rengasamy, R. 2012. Effect of *Kappaphycusalvarezii* SLF treatment on seed germination, growth and development of seedling in some crop plants. *J. of Acad. Industrial Res.*, 1(4):186-195.
4. Balamurugan, G. and Sasikumar, K. 2013a. Effect of Seaweed Liquid Fertilizer of *Sargassummyryocystem* of *Abelmoschusesculentus* L. *Int. J. of Curr. Res. and Develop.*, 1(1):33-37.
5. Balamurugan, M. and Sasikumar, K. 2013. Effect of Seaweed liquid fertilizer of *Caulerpa scalpeliformis* on growth and enzymatic activity of *Abelmoschusesculentus* L. *Int. J. Curr. Res. and Develop.*, 1: 112-120.
6. Bhosale, N. B., Untawale, A. G. and Dhargalkar, V. K. 1975. Effects of seaweed extract on the growth of *Phaseolus vulgaris* L. *Ind. J. Mar. Sci.*, 4: 208-210
7. Dhargalkar, V. K. and Pereira, N. 2005. Seaweed: Promising plant of the millennium. *Sci and culture.* 71(3-4): 61-66.
8. Kalaivanan, C., Chandrasekaran, M. and Venkatesalu, V. 2012. Effect of Seaweed liquid extract of *Caulerpa scalpeliformis* on growth and biochemical constituents of Black gram (*Vignamungo* (L.) Hepper). *Phycos.*, 42(2): 46-53.
9. Kirk, J. O. T. and Allen, R. L. 1965. Dependence of chloroplast pigment on actidione *Arch. Biochem. Biophys. Res. Commun.*, 21: 523-530.
10. Mohan, V. R., Venkataraman K. R., Murugeswari, R. and Muthusamy, S. 1994. Effect of crude and commercial seaweed extract on seed germination and seedling growth in *Cajanuscajan* L. *Phykos.* 33: 47-51.
11. Paul, J. P. and Mahadevi, B. 2014. Effect of Seaweed liquid fertilizer of *Caulerpa peltata* Lamour (Green Seaweed) on *Vignaradiata* (L.) R. Wilczek., in Indian thakarai, Tamilnadu, India. *World J. Pharmacy and Pharma. Sci.*, 3(6):1000-1007.

12. Pise, N. M. 2009. Physiological studies on application of seaweeds to vegetable crops. M. Phil thesis submitted to Shivaji University Kolhapur. 116p.
13. Rama Rao, K. 1990. Preparation, Properties and use of liquid fertilizer from Sargassum. "Workshop on Algal products", seaweed research and utilization Associationship. 78.
14. Shri Devi, S. D. K. and Paul, J. P. 2014. Influence of Seaweed liquid fertilizer of Gracilariadura (Ag.) (Red Seaweed) on Vignaradiata (L.) R. Wilczek., In Thoothukudi, Tamilnadu, India. World J. Pharmacy and Pharma. Sci., 3(4):968-97
15. Sujatha, K. and Ramamurthy, K. 2011. Effect of Sargassum and Turbinaria seaweed extracts on physiological and yield attributes in pigeonpea (Cajanuscajan L.). Int. J. Agric. Sci., 7(1):47-50.



## “Green Approach of Spent Wash To Decrease The Dose of Fertilizer Quantity For Soil In Village Dholewadi from Shirala Tahasil”

**Dr. A. B. Patil<sup>1</sup>, A.D. Patil<sup>2</sup>, Dr. S. M. Patil<sup>3</sup>**

1. Department of Chemistry, D. A. B. N. Arts and Science College, Chikhali, Affiliated to Shivaji University, Kolhapur.

2. Department of Physics, D. A. B. N. Arts and Science College, Chikhali, Affiliated to Shivaji University, Kolhapur.

3. Department of Chemistry, D. A. B. N. Arts and Science College, Chikhali, Affiliated to Shivaji University, Kolhapur.

### Abstract:

*Soil analysis deals with various chemical processes that determine the amount of available plant nutrients in soil. It also gives information about Chemical, physical and biological health of soil. Rapid industrial activities and increasing population growth increases the demand of fresh water and food. To overcome this problem we use spent wash, generated from alcohol industry. We collect soil samples from particular plot of Shirala Tahasil. Analysis of collected soil was carried out with respect to P<sup>H</sup>, Electric conductivity and micro nutrients like Nitrogen, Phosphorous, Potassium, Organic Carbon, Calcium, Copper, Iron, Manganese, Zinc etc. After giving proper dose of spent wash through irrigation water to particular plot, again we carry out analysis of soil for above mentioned micronutrients. We concluded that level of micronutrients was increased after giving spent wash. So on the basis of fertilizer dose suggested for micronutrients and N. P. K after spent wash spraying was decreased as compared to fertilizer dose suggested after spent wash spraying. This also helps to decrease the pollution problem due to spent wash and reduction in amount of fertilizers required.*

**Keywords:** Soil, fertility, micronutrients, Fertilizers, P<sup>H</sup>, Electrical Conductivity.

### Introduction:

For healthy plant growth in soil treating of recycling spent wash will play an important role in agriculture development. Lot of research work have been published on the beneficial effect of spent wash on the crop yield. Better yield of crop is based upon soil pH & fertility of soil. Determine fertility status of soil through soil sampling & testing is one of the most important steps to attain success in crop production. Soil analysis provides information of nutrient deficiency & availability nutrient status of soil, which is necessary factor for healthy plant growth. National health of plant is mainly depends upon availability of micro nutrients like P, Ca, Mg, K etc. in soil. It has proved that soil intelligent decisions on the amount & composition needed to achieve a selected yield goal.

### Methods of Analysis:

1) **Collection of the Sample:** Sample is collected as per the recommended procedure [1].

2) **Required Chemicals:** All of the chemicals are prepared as per the recommended procedure.

All of the chemicals are used AR grade [2, 3, 4]

3) **Instruments:** [1]

a) PH meters- Model EQ-610

b) Conductivity Meter- Model EG-660

c) Atomic Absorption Spectro Photo Meter-Model

d) Spectro Photo Meter-

e) Flame photometer.

### Results of Analysis and Discution:

From the analysis of soil results obtained from sample are summarized in given table.

Table No : I. Result of analysis of Soil before addition of spent wash.

Sr. No	Parameter	Unit	Observed value	Limit
1	pH	-	6.65	6.5-8.5
2	E-Conductivity	Mmhos/cm	0.18	<4.0
3	Nitrogen	Kg/ha	94.60	100-200
4	Phosphorous	Kg/ha	18.00	30-40
5	Potassium	Kg/h	350.00	110-280
6	Organic Carbon	%	0.43	>0.50

7	Calcium	%	2.75	0.1-3.2
8	Copper ( Cu)	Ppm	0.58	0.3-0.5
9	Iron (Fe)	Ppm	2.50	2.5-4.5
10	Manganese (Mn)	Ppm	2.25	1.0-2.0
11	Zinc (Zn)	Ppm	0.40	0.5-1.2

Table-IIA. As per the soil analysis fertilizers has suggested per Acer given in the

Sr. No.	Time factor for use of fertilizer.	Pack in Kg	Method I			Method II		Method III		
			Urea	Super Phos.	Potash	Urea	10:26:26	Urea	DAP	Potash
1	Plantation	50 kg	1.00	4.50	1.00	0.50	2.50	0.50	1.50	1.00
2	After 6 to 8 week	::	4.00	-	-	4.00	-	4.00	-	-
3	After 12 to 14 week	::	1.00	-	-	1.00	-	1.00	-	-
4	Final Dose	::	4.00	4.50	1.00	3.50	2.50	3.50	1.50	1.00
	Total→		10.0	9.00	2.00	9.00	5.00	9.00	3.00	2.00

Table- II B As per above soil analysis quantity of fertilizers has been suggested per Acer

Sr. No.	Methods	Micronutrients per Acer			
		Zinc Sulphate	Ferrous Sulphate	Manganese Sulphate	Copper Sulphate
1.	Initial Plantation	5 kg	5 kg	-	5kg
2.	Finally	5 kg	5 kg	-	5 kg

Table No. III Result of analysis of Soil after addition of spent wash.

Sr. No	Parameter	Unit	Observed value	Limit
1	pH		6.35	6.5-8.5
2	E-Conductivity	Mmhos/cm	4.00	<4.0
3	Nitrogen	Kg/ha	715.00	100-200
4	Phosphorous	Kg/ha	105.00	30-40
5	Potassium	Kg/h	648.00	110-280
6	Organic Carbon	%	3.10	>0.50
7	Calcium	%	4.00	0.1-3.2
8	Copper ( Cu)	Ppm	2.60	0.3-0.5
9	Iron (Fe)	Ppm	7.50	2.5-4.5
10	Manganese (Mn)	Ppm	7.10	1.0-2.0
11	Zinc (Zn)	Ppm	2.25	0.5-1.2

Table-IVA As per the soil analysis fertilizers has suggested per Acer given in the

Sr. No.	Time factor for use of fertilizer.	Pack in Kg	Method I			Method II		Method III		
			Urea	Super Phos.	Potash	Urea	10:26:26	Urea	DAP	Potash
1	Plantation	50 kg	0.50	2.00	1.00	-	2.00	0.50	0.50	1.00
2	After 6 to 8 week	::	1.50	-	-	1.50	-	1.50	-	-
3	After 12 to 14 week	::	0.50	-	-	0.50	-	0.50	-	-
4	Final Dose	::	1.50	2.00	1.00	1.00	2.00	1.50	0.50	1.00
	Total→		4.00	4.00	2.00	3.00	4.00	4.00	1.00	2.00

Table- IV B As per the soil analysis fertilizers has suggested per Acer micronutrients given in the

Sr. No.	Methods	Micronutrients per Acer			
		Zinc Sulphate	Ferrous Sulphate	Manganese Sulphate	Copper Sulphate
1.	Initial Plantation	NIL	NIL	NIL	NIL
2.	Finally	NIL	NIL	NIL	NIL

From the data obtained for analysis of soil before addition of spent wash, it is concluded that, pH of soil was observed nearly about 6.69 indicates that soil is neutral.[1-5] Also electric conductivity was observed about 0.18 mm which is normal in range. Also soil contains nitrogen for about 94.60 kg/ha. Phosphorous is also observed in soil for about 18.00 kg/ha as well as potassium is also observed in soil for about 350. Kg /ha. Also soil contains organic carbon for about 0.43 % . Which is medium in range. Also soil contains calcium carbonate for about copper for about 0.58 ppm, Iron nearly about 2.50 ppm. Which is very less in range . Also soil contains Manganese nearly about 2.25 ppm & zinc for about 0.40 ppm. By observing this data dose of fertilizer was suggested in three different steps given in table IIA to a particular plot. [6-10]In First Step urea requires 10 pack, super phosphate 9 pack., potash 2 pack. Where as in second step urea requires 9 pack, 10:26:26 5 pack. Similarly in third step urea 9 pack , DAP- 3 pack & potash 2 pack & micronutrients have been suggested to add 5 kg of zinc sulphate, 5 kg ferrous sulphate as well as 5 kg copper sulphate etc in soil to obtain better result of crop.[11-15]

After giving the spent wash in the selected plot and then analysis was carried out . Soil verify the elements as well as micronutrients these composition have been mentioned Table No. III. In soil pH observed nearly about 6.35 indicates that soil is acidic in nature. Also electrical conductivity is observed in soil which is not suitable for soil. Soil contains nitrogen nearly about 715.00 kg/ha which is large in range as compared to normal soil. Also soil contains phosphorous nearly about 105.00 kg /ha as well as potassium for about 648.00 kg /ha which is greater in range as compared to normal soil. Also spreaded spent wash soil contains organic carbon about 3.10 % which is greater in range . Soil contains calcium carbonate for about 4.0% which is normal in size. Also soil contains copper about 2.60 ppm, Iron about 7.50 ppm & Manganese nearly about 7.10 ppm as well as zinc for about 2.25 ppm. All these compositions are greater in range as compared to normal soil. From observation obtained after spent ash addition, suggested three different methods for giving the fertilizers as well as micronutrients to particular plot is given in Table No IVA & IVB [15-20]. After applying spent wash to soil amount of urea sample is reduced for about 60 % . Also amount of single super phosphate is reduced for about 50 % . Murate of potash is not reduced. Also amount of 10:26:26 sample is reduced for about 10 % and amount of DAP is reduced for about 20 % as compared to normal soil. As well as micronutrients are completely reduced.

### Conclusion:

From above discussion we concluded that, after applying spent wash we can save 18565\--amount per acer. It minimizes quantity of fertilizers, reduces soil pollution due to excess fertilizer and reduces total cost on fertilizer.

Sr. No.	Type of fertilizer	Fertilizer dose in bags suggested before spent wash	Fertilizer dose in bags suggested after giving spent wash	Difference dose of fertilizer in bags	Reduction in Prize
1.	N P K	30	23	07	15565\-
2.	Micronutrients	30	00	30	3000\-
	Total				18565\-

### Acknowledgements:

I take this golden opportunity to express my heartily thanks and deep sense of gratitude to, Smt. Dr S.M Patil Smt. Shri. Borage V.I., Shri. Kumbhar D. D., Shri. Babaso Vanare and who has been a constant source of encouragement to complete this paper work and giving her excellent guidance and suggestion from

time to time during course of this work. Lastly, I would like to especially thank to Principal Dr. S. R. Patil for his valuable guidance.

### Reference:

1. *Instrumental methods of analysis*, Hobert H. Willard, Lynne L. Merritt, Jr. Text book of practical organic Chemistry – A. I. Vogels.
2. *Soil Microbiology, A texture of Soil Science*, Dr. J. A. Daji, Dr. J. R. Kadam, Dr. N. D. Patil
3. Dr. A. B. Patil, A.D. Patil, *By using industrial waste for deduction of production cost in village kande International Journal of Creative Research Thoughts* ISSN/ISBN No. 230 -2882.
4. Dr. A. B. Patil, A.D. Patil, *Relation Between Spent Wash & Production Cost Studied In Village, Jambhalewadi. Journal of Chemistry and Chemical Science* ISSN /ISBN No. 2319-7625. VOLUME 8, ISSUE 3, MARCH 2018.
5. Biswas T.D. and Mukharjee S.K. 2000. *Text book of soil science (2<sup>nd</sup> edn)* . Tata McGraw-Hill Publishing Company, New Delhi.
6. Gupta P.K. 2000. *Soil, plant, water and fertilizer analysis (1<sup>st</sup> edn)* Agro Botanica , Bikaner.
7. Kadam J.R. and Patil N.D. 2001. *A text book of soil science, Media promoters and publishers PVT. Bombay.*
8. Kiran K.D. et. al 2006, *Antimicrobial activities of a novel Streptomyces isolate from soil samples. Indian J. Comparative animal physiology.*
9. Maheshwari S.K. 2004, *Text book of life science, Cominant Publishers and Distributors.*
10. Patil, J.D., S.V. Arbatti and D.G. Hapase, 1982. *Humification of spentwash in soil. J. Maharashtra. Agric. Univ., 7(1): 80-83.*
11. Ramamurthy B, R.L. Narsinghan and R.S. Dinesh. 1967, *Fertilizer application for Specific yield target of sonara-64 wheat. Indian Fmg.*
12. Sharma P.D. 2004, *Ecology and environment (7<sup>th</sup> edn)* , Rastigi publications , Meerut. Sing M. 2007, *physico - chemical characteristics and Nutrient status of Soils of Tarntarn district of Punjab. Indian J. Env. Ecoplan.*
13. Somawanshi R. B. et.al. 1999. *Analysis of plants irrigation water and soil. Department of Agricultural chemistry and soil science, M. Phule Agricultural University, Rahuri.*
14. S. Mahimairaja and N. S. Bolan, "Problems and Prospects of agricultural use of distillery spentwash in India." *In: Proceedings of Supersoil 2004: 3rd Australian New Zealand Soils Conference, University of Sydney, 2004, Australia. pp.1-6.*
15. Verma P.S. and V.K. Agarwal. 1987. *Environmental Biology (3<sup>rd</sup> edn)*. S. Chand and Company, New Delhi.
16. Murugaragavan, R., 2002. *Distillery spentwash on crop production in dryland soils. M.Sc. Thesis, Tamil Nadu Agric. Univ., Coimbatore.*
17. Brian S. Furniss, Antony J. Hannaford, Peter W.G. Smith-Vogels *Text book of practical chemistry.*
18. Dr. A. B. Patil, A.D. Patil *International Journal of Science and Research (IJSR) ISSN (Online): 2319-7064 Volume 5 Issue 10, October 2016 Impact of Spent Wash on Black Soil Properties in Village, Natoli*
19. Dr. A. B. Patil, A.D. Patil *Assessment of the impact of spent wash use on black soil properties' in village wadibhagai, International Education & Research Journal, Page 52 to 54, Volume : 2 | Issue : 11 | Nov 2016*



## Impact Of Climate Change On Agricultural Productivity Productivity In Kadegaon Tehsil Of Sangli District (M.S.) India.

**Dr.Pore Sanjay Vishnu**

Associate Professor and Head

Department of Chemistry, Bharati Vidyapeeth's Matoshari Bayabai Shripatrao Kadam KanyaMahavidyalaya, Kadegaon, Dist:Sangli (M.S ) India, 415304

### Abstract:

*Climate change induced especially challenging influence on agricultural productivity. Agricultural productivity is measured as the ratio of agricultural outputs to its inputs. Impact of climate change on five important crops: Triticum aestivum variety of wheat & Zea mays variety of Maize, ( Both the from family Poaceae) have been studied. The results show that agriculture and human well-being is negatively affected by climate change. Crop yields are declined, production is affected and consumption of cereals is falling down, leading to reduction in calorie intake and increase in child malnutrition. The greenhouse gas emissions are raising the earth's temperature. The consequences include melting glaciers, more precipitation, more and more extreme weather events, and shifting seasons. The accelerating pace of climate change, combined with global population and income growth, threatens food security everywhere. Agriculture is extremely vulnerable to climate change. Higher temperatures eventually reduce yields of desirable crops while encouraging weed and pest proliferation. Changes in precipitation patterns increase the likelihood of short-run crop failures and long-run production declines. Although there will be gains in some crops in some regions of the kadegaon tehsil, the overall impacts of climate change on agriculture are expected to be negative, threatening global food security.*  
**Keywords:** Climate Change, Agricultural productivity, Environmental pollution, Average rain fall

### Introduction:

Environmental pollution is a wide spread expression for which we have become acquainted. Environment over the decades is fast changing mainly due to anthropogenic activities. Today's era of industrialization and commercialization exploit natural resources on large scale which is contamination of our surrounding. Climate change is really posing serious threat to the existence of life for animal, plant and human being also on the earth. There challenges have become a matter of serious concern to all of us.

Climate change is natural disaster, which are harmfully affects nature as well as humans. Drought is a part of it frightens of large scale in livelihood, livestock and has a negative impact on local, regional economies. Dry situation affected by the nature, animal and human structure, huge loss of the natural topography on earth surface. The shortage period of rainfall is occurred leads to decrease in high water level. Basin catchment areas receive very low rainfall in a short period. Dry Nandani and Yerala rivers usually result from abnormally shortage rainfall and high temperature. The small amount of release of rainfall, water was insufficient to fulfill the water storage networks in affected study region. Drought of the study area depends on number of cause and its impact on the basic of the human and natural life. Constructions structure of nature its worst effect on the human life cycle in the study area. The basic pattern of the study area is dry basins, naturally loss of streams, open pattern of soil low canopy of vegetation and scarcity rainfall due to drought and dry regimes. During the drought year 2016-2017 was affected in Nandani and Yerala basins in kadegaon Tehsil of Sangli district.

### Material and Method:

**Study Area:** Agriculture is an important activity in kadegaon tehsil of Sangli District. More than 65% population of it depends directly or in directly on the agriculture. The agriculture sector plays a significant role in the overall socio-economic development in kadegaon tehsil of sangli district. Kadegaon is a taluka place with dry and arid climate and is located in rural and hilly area of Sangli district in Maharashtra. It is rapidly growing city on account of trade and agricultural practices located at 17<sup>o</sup>18' N. latitude and 74<sup>o</sup>21' E longitudes. The majority of population lives in rural area and most of the peoples in these villages are economically dependent on agricultural practices. The majority of the farmer cultivates various crops like wheat, maize, soybeans, and groundnuts other than sugarcane and grapes etc. due to scarcity of water and according to the economical point of view by using excess various Chemical fertilizers and pesticides in their field which affects agricultural profile, which is very harmful to the proper vegetation of the crops under cultivation. Farmers from in and around kadegaon tehsil are no exception to this.

**Objectives:** To Study impact of climate change that is drought on primary productivity of village wise agriculture area in kadegaon tehsil.

**Methodology:** The methodology consists of data collection of average rainfall and comparative average agricultural production by mock interview with major farmers from all villages under study. Monthly average rainfall data from 58 Gram Panchayat offices were used.

### Causes Of Drought In Study Area:

Drought in kadegaon tehsil of Sangli district is mainly due to the failure of rainfall and dry regimes. In the study area, both natural and anthropogenic activities are mainly responsible. The main natural causes are long time failure of rainfall, short period of rainy-days, increasing the high temperature and evaporation, topography pattern, water imbalances and desiccating winds etc., Major human activities are deforestation. Wrong performances in land use more sand take on river beds, continuous same cropping pattern. Farming on the river channel, huge range of construction etc. To the parallel natural as well as human accident earth climatic evidence to change the long period resulted Nandani and Yerala river basin decreasing rainfall pattern.

Kadegaon tehsil of Sangli district suffers in the four month monsoon climate, i.e. June to September. In the Sangli district climatic phenomena particularly rainfall was very confusion. In the district parallel situation occurred in both side in west heavy flooding and in east high drought. Studied over the last few decades, there have been many experiments in nature. Some of the other factors which have directly or indirectly contributed to the occurrence of dry condition.

The fundamental of scarcity precipitations is the basis of the drought hazard. Very low rainfall in the catchment areas of Nandani and Yerala basin. Worried basin cause to regular insufficient of water to whole stream of Nandani and Yerala river in Study region Scarcity rainfall, during the year 2012-13 and 2013-14 for long period in continuation is the origin cause of drought. A dry river due to complete low rainfall and large scale temperature and evaporation is the essential condition for drought. That condition creates the basin of Nandani and Yerala from year. 2016-17 and 2017-18

**TABLE: 1** The sample coding for cluster of five neighboring villages under study area in Kadegaon tahsil of Sangli district.

**Fig.1.** Shows Cluster wise average rainfall for monsoon period between 1<sup>st</sup> June to 31<sup>st</sup> September 2016-17.

**Fig.2.** shows Cluster wise average rainfall for monsoon period between 1<sup>st</sup> June to 31<sup>st</sup> September 2017-18.

### Impact Of Drought In Primary Productivity Of Agriculture:

The climate ambitious water scarcity and increases in the severity of droughts which is affected on crop production. Small scale and marginal landholders and number of dependent on related to primary agricultural field. The climate calamities drought is the most common hazards. In the eastern part of study area in cluster of villages from A to D and east part of study area in cluster of villages from I to L have a high affected the dryness and drought prone regions. The massive effected was agriculture crop growing live stokes, human health and drinking water etc., Impact on numbers of villages the growing incidence of drought disasters is highly correlated to the increasing vulnerability of the local economy. Affected famous crops are wheat, maize, soybeans, and groundnuts, some patches of Groundnuts, Maize, sugarcane etc. whole crops was damaged in the drought Monsoon whether gated the cloudy but no rainfall start in this region results availability for crop growing process stopped and the sun to reduces the humidity of atmosphere in this region.

In drought year 2016 to 2018 in the tehsil affected primary productivity agricultural land more affected farmers in study area. During the two years drought situation on agriculture land affected more than 50% farmers. More than 90 per cent loss on the crops by drought and then occurred high heat on crop viral influences end of day result was the remaining crop only stay to chars. Farmers not get the crop production in any kind of condition

### Result and Discussion

In the study area eastern part having a drought impact in cluster of villages from A to D and western part of study area in cluster of villages from I to L have affected the dryness and drought prone regions. The investigation of the randomly surveys (2016-2018), observation, mock interview and number of references to found drought high affected on the entire family and number of farmers depending only on the farms.

### Conclusion:

Climate change places new and more challenging demands on agricultural productivity. Crop and livestock productivity-enhancing research, including biotechnology, will be essential to help overcome stresses due to climate change. is that improved agricultural productivity, even if not targeted to the poorest of the poor, can be a powerful mechanism for alleviating poverty indirectly by creating jobs and lowering food prices. Productivity enhancements that increase farmers' resilience in the face of climate-change pressures will likely have similar poverty-reducing effects. Rural infrastructure is essential if farmers are to take advantage of improved crop varieties and management techniques. Higher yields and more cropped area

require maintaining and increasing the density of rural road networks to increase access to markets and reduce transaction costs. Investments in irrigation infrastructure are also needed, especially to improve the efficiency of water use, but care must be taken to avoid investments in places where water availability is likely to decline.

**Acknowledgement:** Author is very much thankful to the principal of Bharati Vidyapeeth's Matoshri Bayanai Shripatrao kadam Kanya Mahavidyalaya kadegaon and to the village officers and farmers of all the villages from kadegaon tehsil during the course of this investigation.

**TABLE: 1** The sample coding for cluster of five neighboring villages under study area in Kadegaon tehsil of Sangli district

Sr.	Sampling Place Cluster of Villages	Sample Code	Sr.	Sampling Place Cluster of Villages	Sample Code	Sr.	Sampling Place Cluster of Villages	Sample Code
1	Raygaon	A	21	Kotij	E	41	Shirgaon	I
2	Bombalewadi		22	Kherade (vita)		42	Shirasgaon	
3	Hingangaon (BK.)		23	Tupewadi(Kh)		43	Sonsal	
4	Shalgaon		24	Bhikewadi(kh)		44	Sonkire	
5	Yede		25	Hanmant vadiye		45	padali	
6	Karandewadi	B	26	Shivaji nagar	F	46	Vajegaon	J
7	Belawade		27	Kadegaon		47	Chinchani	
8	Vihapur		28	Kadepur		48	Ambak	
9	Renushewadi		29	Chikhali		49	Asad	
10	Nimsod		30	Amarapur		50	Vadgaon (Mohite)	
11	Upale (wangi)	C	31	Nevari	G	51	Ramapur	K
12	Upale(mayani)		32	Ambegaon		52	Deorashtre(E)	
13	Saspase		33	Yevlewadi		53	Deorashtre(W)	
14	Tondoli		34	Shivani		54	Kumbhargaon	
15	Soholi		35	Vadiye raibaag				
16	Dhanewadi	D	36	Hingangaon(kh)	H	55	Apshinge	L
17	Kherade(wangi)		37	Shelakbao		56	Khambale(A)	
18	Kanherwadi		38	Tadsar		57	Kotaweade	
19	Yetgaon		39	Wangi-East		58	Nerli	
20	Tupewadi(y)		40	Wangi-West				

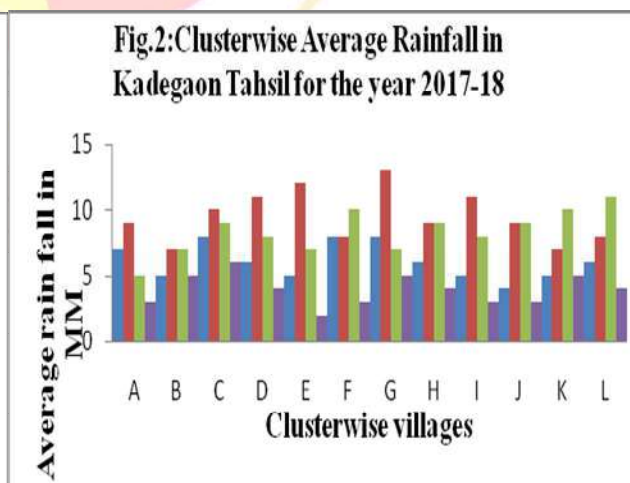
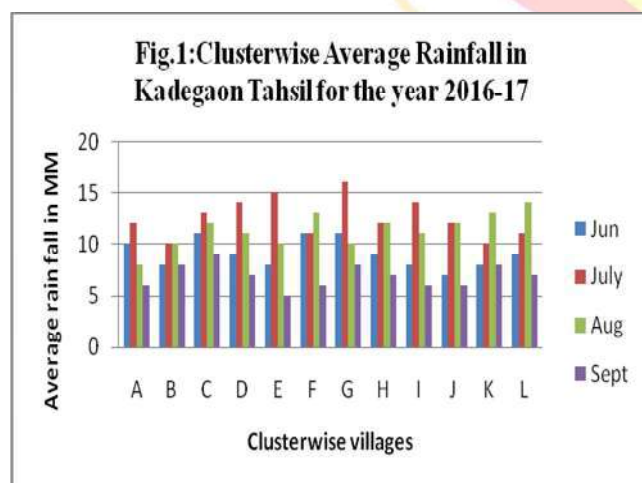

#### References :

1. Agricultural Department, Sangli district, (2012-14)
2. Brammer, H. (1990), Floods in Bangladesh I : Flood Mitigation and Environmental Aspects: The Geographical Journal, Vol. 156, No. 1, pp 12-22
3. Burman S. G. (1977) , Floods and its control in Deshbandhu and E. Chauhan (eds). Trends in Indian Environment, New Dehli Today and Tomorrows Priters and publishers
4. Cichocki, A.,S. Amari, et al. (2004) ICALAB for Image Processing: Toolbox for ICA, BSS, BSE

## Role of nanotechnology to control and prevent air and water pollution: A bird's eye view

<sup>1</sup>Prabhakar Kute, <sup>2</sup>Nandkishor Chaudhari\*

<sup>1</sup>Department of Chemistry, PratishthanMahavidyalaya, Paithan, Dist. Aurangabad.[M.S.]

<sup>2</sup>Department of Physics, PratishthanMahavidyalaya, Paithan, Dist. Aurangabad.[M.S.]

### Abstract:

Now a day's air and water pollution becomes a major challenge faced by human being. Air contains the pollutants such as CO, hydrocarbon, nitrogen oxides whereas water is also contaminated with use of large amount of pesticides, fertilizers, releasing the toxic chemicals, heavy metals as well as microbial pathogens. These pollutants adversely influenced the human health. The recent advances in nanotechnology have a great deal of interest in controlling and monitoring the environmental pollution. Nano materials are known to be excellent adsorbent, catalyst and sensors because of their large surface area and high reactivity and significantly changed physical, chemical and biological properties. This paper reviews on overview of application of nano materials in air and water pollution control.

**Keywords:** Air pollution, Water Pollution, nanotechnology.

### Introduction:

Now a day's environmental contamination becomes a major issue that faced by the human being on the earth and expanded day to day due to extensive industrial activities involving transportation, petroleum refining, mining, manufacturing and construction which evacuates the natural resources and producing a huge amount of hazardous waste materials are causing the air and water pollution. The industrial wastes are released in to environment in the form of various toxic gases such as nitrogen, sulphur, carbon monoxides, and volatile organic compounds. The water contaminated with organic and inorganic compounds. The major source of water contaminations are sewage water, industrial effluents, organic substances such as pesticides, insecticides, heavy metals as arsenic, lead, cadmium, mercury etc and microbial pathogens which adversely affects the human health and ecosystem. They enters in the human body through inhalation, ingestion or absorption

Nanotechnology is referred as to design, synthesis, characterization, production and applications by changing the shape, size of the particle at nano metric scale i.e. between 1 to 100 nm range [1] and covers wide range of field such as medicine [2,3], food industry [4-5], energy [6] and pollution treatments [7]. There are several nanomaterials including carbon nanotubes, nano composites, quantum dots, fullerenes, quantum wires and nano fibres [8]. These nano particles exhibit the characteristics due to their high surface/volume ratio and make them more reactive than in bulk form of same materials [9]. Tiwari et al [10] classified these nanoparticles into four groups as 1] zero dimensional [2] one dimensional [3] two dimensional and [4] three dimensional nano structures.

Considering the remarkable advantages of nanotechnology and essential need to develop the green and economic approaches for atmospheric remediation this paper presents a review on the application of nanomaterials in air and water pollution sector. These nanomaterials are synthesised using various techniques such as wet chemical methods, sol gel techniques, hydrothermal process, and co-precipitation method. The nanomaterial synthesised using these methods are found to provide advanced features for various applications due to their extra ordinary properties. The nanomaterials are excellent adsorbents, catalysts and sensors due to their large surface area and high reactivity.

Many applications of nanotechnology such as nano sensors and nano scale coating, wasteful polymer coating prevents the corrosion, nano sensors for the detection of aquatic toxins, nano scale biopolymers for improved decontamination, smart particles for environmental monitoring and purification, nano particles as photo catalysts [11-14].

### Applications of nanotechnology for air pollution control:

Air pollution is considered to be one of most dangerous and common type of environmental pollution. Imbalance of quality of air causes an adverse effect on living being on the earth. There are two types of

pollutants - primary pollutants that are directly emitted from an identifiable source produced by the natural events and human activities (CO, CO<sub>2</sub>, SO<sub>2</sub>, NO, NO<sub>2</sub>etc). Secondary pollutants are produced in the atmosphere when the certain chemical reaction takes place among the primary pollutants ((HNO<sub>3</sub>, SO<sub>3</sub>, H<sub>2</sub>SO<sub>4</sub>, H<sub>2</sub>O<sub>2</sub>etc). Sources for air pollution are classified as Natural sources – volcanic eruption which releases very large number of poisonous gases, depletion of sand, dust etc another is the anthropogenic sources includes deforestation, burning fossil fuel and fires, emission of vehicles and rapid industrialization. All these have an adverse effect on human health causing various types of diseases which can be fatal such as cancer, respiratory and cardiovascular diseases.

Global warming leads to many changes in the environment. Green houses are considered the direct contribution to the global warming and the greenhousegases are carbon monoxide, carbon dioxide, methane, nitrous oxide etc[15].

Sofian et al [16] and Yadav et al [17] stated that nanotechnology presents environmental benefits in controlling the air pollution and classified in to three different ways as remediation and treatment, detection and sensing and prevention of the pollution. There are three different ways in which nanotechnology is used to reduce air pollution i.e adsorption by nanoadsorptive material, degradation by nano catalysts and separation by nano filters. The adsorption on nano material is efficient and cost effective process due to high surface area of nano material which enhances the adsorption capacity. The solid adsorbents for capturing the carbon dioxide is divided in three ways [1] high temperature adsorbents [2] intermediate adsorbents and [3] low temperature adsorbents [18]. Carbon nano structures having an average pore diameter, volume and surface area makes them for industrial applications as nano adsorbents. Janchen et al [19] pointed out that the Carbon nano tubes have been used to capture CO<sub>2</sub> and enhance the adsorption performance in presence of moisture and decline the adsorption capacity due to water molecules competing with CO<sub>2</sub> for the active adsorption sites.

Wand and Lua [20] pointed out metallic nickel nano particles were employed as catalysts for thermal decomposition of methane to produce hydrogen.Saleh et al [21] pointed out that the nanomaterials are used to eliminate SO<sub>2</sub> which release to atmosphere either by desulphurization of fossil fuel or by its removal directly from emission by adsorption process and catalysts oxidation.Titanatenano tubes and their derivatives have been reported for photo catalytic oxidation of NOx. Nguyen and Bai [22] have proved that the surface area, amount of crystalline and the remnant sodium content of TNT increased by washing at pH 3.5 and increased the removal efficiency of both NO and NO<sub>2</sub>.

Indoor air pollutants- volatile organic compounds are considered as very harmful and direct effects to human health [23]. These are the main cause of asthma, hypersensitivity, and symptoms like nausea, headache, lung cancer etc [24].Various methods are used to remove formaldehyde such as decomposition by which photo catalysts and physical adsorption by porous material are used. Stark et al [25] pointed out another indoor air pollutants i.ebioaerosols(aerosols of biological origin such as viruses, bacteria, fungi etc)which spread with air film and causes the diseases including infection and allergies. Silver, copper nano materials, carbon nano tubes are considered effective techniques to remove the bioaerosols.

### **Applications of nanotechnology in water pollution control:**

Next to air, water is most important substance for the existence of life on the earth. Water accounts for about 70 % of mass of total of our body. Nearly 70 % of water is frozen as eternal ice and only 1 % can be used for drinking purpose. Now a day a major problem that is facing the living human being is provided a convenient access to clean water that can keep up with rapidly increasing demands.

Watercontaminants may be organic, inorganic and biological. Some of observed to be very toxic and affects the human being and ecosystem [26]. Human activities play a major role in contaminating the water sources by releasing the chemicals, waste water, and heavy metals in the water source. Heavy metal water pollutants with high toxicity are cadmium, chromium, mercury, lead etc, all these have serious toxicities. Nitrates, sulphides, fluorides etc have the hazardous effects and changes the taste of water. The organic pollutants are the pesticides, fertilizers, hydrocarbons phenols, detergents etc are very toxic.

Nanotechnology enables an efficient, flexible and multifunctional process and provides innovative solution in water purification. Nanomaterials having high reactivity, high aspect ratios are found to be environment friendly and non-toxic in purifying the drinking water.

There are many conventional methods for purification of water such as reverse osmosis, distillation, biological treatment, UV treatment ultra and micro filtration etc but all these methods have the limitations such as time consuming, high energy requirement and cannot remove volatile organic and inorganic chemicals.

### **Nanotechnology applications for waste water treatment are described as follows:**

**1] Nano adsorption:** Adsorption is a surface process where the pollutants are adsorbed on the surface. Nano adsorbents are used to remove the organic, inorganic contaminants, bacteria. Nano adsorbents have the properties such as small size, high reactivity, large surface area; ease of separation make them an ideal material in waste water treatment.

The carbon based [27], metal based [28], magnetic/non-magnetic [29-30], oxide composite and zeolites [31] are the nano adsorbents used in water treatment. Carbon based nano adsorbents remove the organic contaminants, heavy metal ions. Metal based nano adsorbents are iron oxide, titanium oxide, zinc oxide are used to remove the heavy metals. Magnetic nano adsorbents are known to be very good adsorbing material for the collection and remove the toxic elements from contaminants water. Polymeric nano adsorbents are used for the removal of heavy metals from water. The main advantage of polymer inorganic nano adsorbents is their good adsorption capacity and good thermal stability over a range of pH.

**2] Membranes:** This process is very effective for water remediation due to its high separation efficiency, easy operation when no chemical added or thermal input is required and does not lead to secondary pollution as well as no regeneration is required [32-33]. It is thin layered material and allows the water molecules to pass and restricts the passage of salts, bacteria, virus and metals. It uses electrical technologies. Based on the pore size and filtration applications membrane process can be separated as microfiltration, ultra filtration and nanofiltration. Nano fibre membrane removes micro sized particles from the water [34]. They are used in pre-treatment prior to ultra-filtration or reverse osmosis.

Nano composite membranes are promising filtration unit and made up of ordered mesoporous carbon as nano fillers. This membrane shows good permeability to pure water, leaving contaminants behind the membrane [35]. Thin film nano composite membrane (TFN membrane) containing silver nano particles in thin layered improve the water permeability and demonstrated anti-bacterial effects on the growth of *Pseudomonas aeruginosa* [36]. Also TFN membrane containing  $\text{TiO}_2$  nano particles improves the NaCl rejection.

**3] Photo catalysis:** It is an oxidation process used in water treatment. It is based on the oxidative elimination of micro pollutants and microbial pathogens [31, 37]. Photo catalysis shows a substantial potential, environmental friendly, sustainable water treatment technology.

Many organic pollutants can be degraded by heterogeneous photocatalysis.  $\text{TiO}_2$  is known to be validated photo catalysts as it is readily available, safe and inexpensive.

**4] Antimicrobial activity of nano materials:** The chemical disinfectants are chlorine, chloramines. They react with other constituents in water and generate harmful disinfection by product. Nano-silver, nano-ZnO, nano  $\text{TiO}_2$ , carbon nano tubes, fullerenes shows antimicrobial properties without strong oxidation. They have lower tendency to form DBPs [38]. Polymeric nano particles are found to kill the microorganisms by releasing antibiotic, antimicrobial, peptides, and antimicrobial agents and by contact – killing cationic surfaces. Nano polymeric antimicrobial materials also show long term antimicrobial activity. They are non-volatile and very stable.

### **References:**

1. Mansoori GA, Soelaiman TF: "Nanotechnology – an introduction for standards community, J ASTM Int. 2:1-21, 2005.
2. Muller B, Zumbuehi A, Walter MA, Pfohi T, Cattin PC, Huwyler J, Hieber SE: Translational medicine: nanoscience and nanotechnology to improve patients care. The nano-micro interface: bridging the micro and nano worlds, 289-310, 2015, books.google.com
3. Usui Y et al : Carbon nano tubes with high bone tissue and bone formation acceleration effects, Small 4:240-246, doi:10.1002/smll.200700670.

4. Duncan TY: applications of nanotechnology in food packing and food safety: barrier materials, antimicrobials and sensors, *J. Colloid Interface. Sci.*, 363:1-24, 2011.
5. Shanthilal J, Bhattacharya S : Nano particles and nanotechnology in food, In *Conventional and advanced food processing technology*, Wiley, 6567-94, 2014.
6. Hussein AK: Applications of nanotechnology in renewable energy – a comprehensive overview and understanding, *Renew Sust. Ener. Rev.*, 42:460-476, 2015.
7. Brame J, Li Q, Alvarez PJJ : Nanotechnology enabled water treatment and reuse: emerging opportunities and challenges for development countries, *Trends food Sci. Techn.*, 22 : 618-624, 2011.
8. Georgalilas V, Permann JA, Tucek J, Zboril R : Broad family of carbon Nanoallotropes: classification, chemistry and applications of fullerenes, carbon dots, nanotubes, grapheme, nanodiamonds and combined superstructures, *Chemical Rev.*, 115: 4744-4822, 2015.
9. Mukherjee PK: Nanomaterials: materials with immense potential, *J. of Applicable Chemistry*, 5(4):714-718, 2016.
10. Tiwari JN, Tiwari RN, Kim KS: Zero dimensional, one dimensional, two dimensional and three dimensional nanostructured materials for advanced electrochemical energy devices, *Prog. in Material Sci.*, 57(4):724-803, 2012.
11. Khan I, Farhan M, Singh P, Thiagarajan P: Nanotechnology for environmental remediation, *Res. J. Pharma. Biolo. And chemi. Sci.*, 5(3): 1916-1927, 2014.
12. Das S, Sen B, Debnath N: Recent trends in nanomaterial applications in environmental monitoring and remediation, *Envirn. Sci. Poll. Res. Inter.*, 22(23):18333-44, 2015.
13. Mehndiratta P, Jain A, Srivastava S, Gupta N: Environmental pollution and nanotechnology, *Field environ. andpollu.*, 2(2):49-58, 2013.
14. Chirag PN: Nanotechnology:future of environmental pollution control, *Inter. J. on recent and Inno. Trends in computing and commun.*, 3(2): 164-166, 2015.
15. Ibrahim RK, Hayyan M, Alsaadi MA, Hayyan A, Ibrahim S: Environmental application of nanotechnology: air, soil and water, *Environ. Sci, Pollu. Res.*, DOI 10.1007/s11356-016-6457-z, 2016.
16. Sofian I, Harwin Y, Kurniawan A, Adityawarman D, Indarto A: Nanotechnologies in water and air pollution treatment, *Environ. Tech. Rev.*, 1(1): 36-148, 2012.
17. Yadav KK, Singh JK, Gupta N, Kumar V: a review on nanobioremediation technologies for environmental clean-up: A novel biological approach, *J. Mater. & Environ. Sci.*, 8(2): 740-757, 2017.
18. Upender K, Sri Hari Kumar, Lingaiah N, Ramarao KS, Saiprasad PS: Low temperature CO<sub>2</sub> adsorption on alkali metal titanate nanotubes, *Int. J. Greenhous gas control*, 10:191-198, 2012.
19. Janchen J, Mohlmann DTF, Stach H: Water and carbon dioxide adsorption properties of natural zeolite and clay minerals at martian surface temperature and pressure conditions, Wenfu Y. (eds) *Studies in surface science and catalysts*, Vol. 170, Elsevier, NY, 2116-2121, 2007.
20. Wang HY, Lua AC: Development of metallic nickel nanoparticles catalysts for the decomposition of methane into hydrogen and carbon nanofibres, *J. Phys. Chem. C*, 116:26765-26775, 2012.
21. Saleh TA, Shuaib TD, Danmaliki GI, Al-Daous MA: Carbon based nanomaterials for desulfurization, classification, preparation and evaluation. *Applying nanotechnology to the desulfurization process in petroleum eng.* 154, 2015.
22. Nguyen NH, Bai H: Effect of washing pH on the properties of titanate nanotubes and its activity for photocatalytic oxidation of NO and NO<sub>2</sub>, *Appl. Surf. Sci.*, 355: 672-680, 2015.
23. Solomon SJ, Schade G, Kuttipurath J et al: VOC concentrations in an indoor workplace environment of a university building, *Indoor Built Environ.*, 17: 260-268, 2008.
24. Lee B, Jung JH, BaeGN: Effect of relative humidity and variation of particle number size distribution on the inactivation effectiveness of airborne silver nanoparticles against bacteria bioaerosols deposited on a filter, *J. Aerosol. Sci.*, 41: 447-456, 2010.
25. Stark PCBH, Ryan LM, Milton DK, Gold DR: Fungal levels in the home and lower respiratory tract illness in the first year of life, *Am. J. Respir. Crit. Care Med.*, 7:168-232, 2003.
26. Ali I: New generation adsorbents for water treatment, *Chem. Rev.*, 112: 5073-5091, 2012
27. Chowdhury S, Balasubramanian R: Recent advances in the use of grapheme family nanoadsorbents for removal of toxic pollutants from waste water, *Adv. Colloid Interface Sci.*, 204: 35-56, 2014.
28. Das SK, Khan MMR, Guha AK, Das AR, Mandal AB: Silver nanobiohybride material: synthesis, characterization and application in water purification, *Bioresour. Technol.*, 124: 495-499, 2012.
29. Rafiq Z, Nazir R, Shah MR, Ali S: Utilization of magnesium and zinc oxide nano adsorbents as potential material for treatment of copper electroplating industry waste water, *J. Environ. Eci. Techn.*, 2:642-651, 2014.

30. Chen L, Xin H, Fang Y, Zhang C, Zhang F, Cao X, Zhang C, Li X : Application of metal oxide heterostructures in arsenic removal from contaminated water, *J. Nanomater.*, 2, 2014.
31. Gehrke L, Geiser A, Somborn-Schulz A: Innovations in nanotechnology for water treatment, *Nanotech. Sci. Appl.*, 8:1-17, 2015.
32. Balamurugan R, Sunderrajan S, Ramakrishna S: Recent trends in nanofibrous membranes and their suitability for air and water filtration, *Membranes*, 1: 232-248, 2011
33. Pendergast MM, Hoek EM: A review of water treatment membrane nanotechnologies, *Energ. Environ. Sci.*, 4: 1946-1971, 2011.
34. Ramakrishna S, Fujihara K, Teo We, Yong T, Ma Z, Ramasheshan R: Electrospun nanofibers solving global issues, *Mater. Today*, 9:40-50, 2006.
35. Fathizadeh M, Aroujalian A, Raisi A: Effect of added Naxnano-zeolite into polyamide as atop thin layer of membrane on water flux and salt rejection in a reverse osmosis process, *J. Membr. Sci.*, 375: 88-95, 2011.
36. Kim ES, Hwang G, Gamal El, Din M, Liu Y : Development of nano silver and multi walled carbon nanotubes thin film nanocomposite membrane for enhanced water treatment, *J. Membr. Sci.*, 394-395, 37-48, 2012.
37. Friedmann D, Mendive C, Bahnemann D: TiO<sub>2</sub> for water treatment: parameters affecting the kinetics and mechanisms of photocatalysis, *Appl. Cata*, B99: 398-406, 2010
38. Li Q, Mahendra S, Lyon DY, Brunet L, Liga MV, Li D, Alvarez PJ: antimicrobial nanomaterials for water disinfection and microbial control: potential applications and implications, *Water Res.*, 42: 4591-4602, 2008.





## Quality of milk in Dairy Plant by Fuzzy Control

S. N. Golgire

Yashwantrao Chavan Warana Mahavidyalaya,  
Warananagar, 416113, Maharashtra, India

M. S. Bapat

Willington College, Sangli,  
416415, Maharashtra, India**Abstract**

This paper deals with an application of fuzzy control theory to determine quality of milk. Classification of raw milk is done by various qualitative properties. Fuzzy sets can be used to describe these properties. Fuzzy control rules are derived by modeling the qualitative properties.

**Keywords:** Fuzzy sets; Fuzzy control rules; Qualitative properties; Quality of milk.

**Introduction**

The concept of fuzzy control theory was introduced by Lotfi A. Zadeh in 1973 and then explored by Mamdani in 1975. In this paper we have discussed the elements of fuzzy control theory and applied it to determine the quality of milk.

The quality of raw milk is classified on the basis of various parameters like Color, Odor, Appearance, Total Micro-organism Count, Methylene Blue Reduction Test Time, FAT, SNF, Proteins, and Added Water etc. In this paper a model with three inputs is given. The output parameter determines quality of milk.

**Preliminaries**

Let  $X$  be a non-empty universe of discourse. The fuzzy set  $A$  on  $X$  is defined by a membership function  $A: X \rightarrow [0, 1]$ . If  $A$  and  $B$  are two fuzzy sets defined on  $X$  then intersection of  $A$  and  $B$  is a fuzzy set on  $X$  defined by  $(A \cap B)(x) = \min\{A(x), B(x)\}$  and union of  $A$  and  $B$  is a fuzzy set on  $X$  defined by  $(A \cup B)(x) = \max\{A(x), B(x)\}$ , for all  $x \in X$ . Fuzzy number is a convex, normal continuous fuzzy set. A triangular fuzzy number is a fuzzy number whose left and right curves are straight lines. Variables whose values are words or sentences in natural or artificial language are called linguistic variables. Linguistic variables can be represented by fuzzy numbers.

**Elements of Fuzzy Control Theory**

Fuzzy Control (FC) consists of *fuzzification interface* in which each crisp input and output parameters are converted into fuzzy sets on universes of discourse with the help of proper shape of membership functions. Usually triangular shape membership functions are used. In *fuzzy rule base* the control action is determined by the evaluation of a set of simple IF-THEN rules. The development of IF-THEN rules requires complete understanding of the process to be controlled. These rules are developed with the help of expert's knowledge. The general form of fuzzy control rules is

$R_i$ : if  $u$  is  $A_i$  and  $x$  is  $B_j$  and  $y$  is  $C_k$  then  $z$  is  $D_l$  (1)

where  $i = 1, \dots, p$ ,  $j = 1, \dots, q$ ,  $k = 1, \dots, r$ ,  $l = 1, \dots, pqr$ ,  $u, x$  and  $y$  are three input parameters,  $z$  is a output parameter, and  $A_i, B_j, C_k, D_l$  are fuzzy sets of the linguistic variables  $u, x, y, z$  in the respective universes of discourse  $U, X, Y$  and  $Z$ . The number of fuzzy terms in input parameters determines the maximum number of fuzzy control rules. The rules with possible fuzzy outputs are presented symbolically on a rectangular table called decision table. In *fuzzy inference engine* the measurement of input variables of a fuzzy controller must be properly combined with relevant fuzzy information values to make inferences regarding the output variables called evaluation of rule. In general there are four fuzzy inference methods as Mamdani Method, Larsen Method, TSK Method and Tsukamoto Method.

A fuzzy implication rule is denoted by  $R_i$  and is defined as

$R_i(u, x, y, z) = [A_i(u) \text{ and/or } B_j(x) \text{ and/or } C_k(y)] \rightarrow D_l(z)$  (2)

where the logical connectives 'and' / 'or' are implemented by the t-norm / t-co-norm. Usually min/max operators are used. The application of a control rule is also called Firing. Conflict resolution or aggregation is the methodology which is used to decide control action. The process conflict resolution is illustrated as follows

Rule 1: If u is  $A_i(u_0)$  and x is  $B_j(x_0)$  and y is  $C_k(y_0)$  then z is  $D_l(z_0)$  (3)

The 'and' part of each rule is called Strength of the rule and is denoted by

$$\alpha_1 = \min (A_i(x_0), B_j(y_0), C_k(x_0)) \quad (4)$$

In fuzzy control output (F.C.O.), the control output of each rule is defined by operation of conjunction on its strength and conclusions are as follows

$$\text{F.C.O. of rule 1: } \alpha_1(z) \wedge D_l(z) = \min(\alpha_1(z), D_l(z)) \quad (5)$$

The outputs of rules are combined or aggregated to produce one control output with membership function  $\text{Agg}(z)$ . For aggregation max operator is used

$$\text{Agg}(z) = \max \{ \min(\alpha_1(z), D_1(z)), \min(\alpha_2(z), D_2(z)), \dots, \min(\alpha_l(z), D_l(z)) \} \quad (6)$$

The *defuzzification interface* which acts as the interface between the FC and the system, by providing the crisp output necessary for acceptance by the system. Defuzzification interface converts a fuzzy set into a crisp number. There are several defuzzification methods are available in literature, two of these are most often used, first is Center-of-Area/Gravity. The defuzzified value of a fuzzy set C is its fuzzy centroid:

$$z_0 = \frac{\int_W z C(z) dz}{\int_W C(z) dz}$$

The calculation of the Center-of-Area defuzzified value is simplified if we consider finite universe of discourse W and is called Mean of Maximum Method. The defuzzified value of a discrete fuzzy set C is defined as a mean of all values of the universe of discourse, having maximal membership values. i.e.  $z_0 = \frac{1}{N} \sum_{j=1}^N z_j$  where  $z_j$ , ( $j = 1, 2, \dots, N$ ) are the members of the universe of discourse which attains the maximum value of C.

**Application to raw milk quality (Three Inputs – One output)**

The Quality of Milk in dairy plant is studied by considering three input parameters with different linguistic variables.

Fuzzification interface: Here the Total Count, FAT and Acidity are taken as three input parameters and grade of raw milk quality is taken as output parameter with different linguistic variables as follows

Total Count (TC)  $\cong$  {Low (L), Medium (M), High (H), Very High (VH)}

FAT  $\cong$  {Low (L), Normal (N), High (H)} Acidity  $\cong$  {Low (L), Normal (N), High (H)}

Quality of raw Milk  $\cong$  {Poor (P), Fair (F), Good (G), Very Good (VG)}

These linguist variables can be represented by a fuzzy set as given below

L M

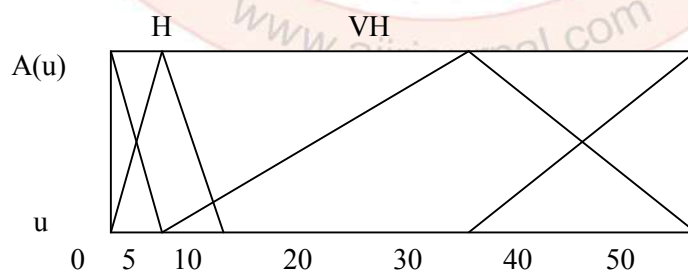

Fig.(1) Total Microorganism Count ( $\times 10^5$  spc/ml)

The membership function for this fuzzy set can be obtained as follows:

$$\begin{aligned} L(u) &= \frac{5-u}{5}, \text{ for } 0 \leq u \leq 5, & H(u) &= \frac{u-5}{25}, \text{ for } 5 \leq u \leq 30, \\ &= 0, \text{ otherwise,} & &= \frac{50-u}{20}, \text{ for } 30 \leq x \leq 50, \\ M(u) &= \frac{u}{5}, \text{ for } 0 \leq u \leq 5, & &= 0, \text{ otherwise,} \\ &= \frac{10-u}{5}, \text{ for } 5 \leq u \leq 10, & VH(u) &= \frac{u-30}{20}, \text{ for } 30 \leq u \leq 50, \\ &= 0, \text{ otherwise,} & &= 1, \text{ for } u \geq 50, \end{aligned} \quad \text{-----(7)}$$

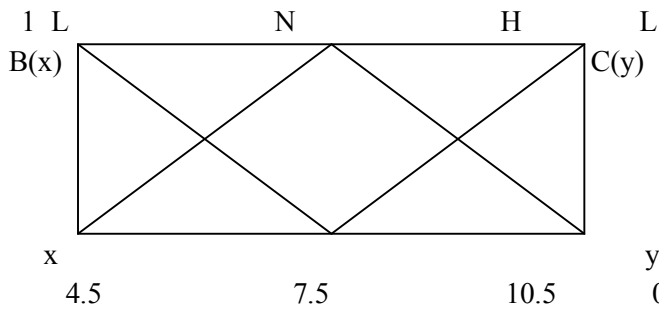

Fig.(2) FAT (%)

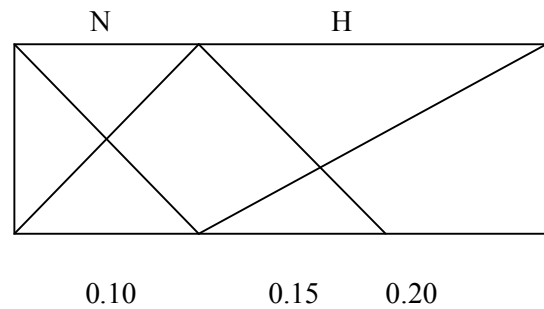

Fig.(3) Acidity (%)

The membership function for this fuzzy set can be obtained as follows:

$$L(x) = \frac{7.5-x}{3}, \text{ for } 4.5 \leq x \leq 7.5, \quad L(y) = \frac{0.10-y}{0.05}, \text{ for } 0.05 \leq y \leq 0.10,$$

$$= 0, \text{ otherwise,} \quad = 0, \text{ otherwise,}$$

$$N(x) = \frac{x-4.5}{3}, \text{ for } 4.5 \leq x \leq 7.5, \quad N(y) = \frac{y-0.05}{0.05}, \text{ for } 0.05 \leq x \leq 0.10,$$

$$= \frac{10.5-x}{3}, \text{ for } 7.5 \leq y \leq 10.5, \quad = \frac{0.15-y}{0.05}, \text{ for } 0.10 \leq y \leq 0.15,$$

$$= 0, \text{ otherwise} \quad = 0, \text{ otherwise}$$

$$H(x) = \frac{x-7.5}{3}, \text{ for } 7.5 \leq x \leq 10.5, \quad H(y) = \frac{y-0.10}{0.10}, \text{ for } 0.10 \leq y \leq 0.20,$$

$$= 1, \text{ for } x \geq 10.5 \quad = 1, \text{ for } y \geq 0.20$$

------(8)

------(9)

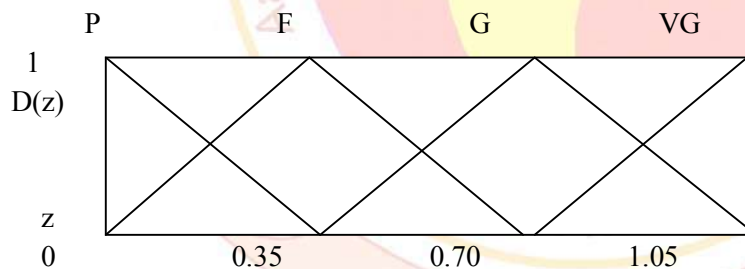

Fig.(4) Grade of Raw Milk Quality

The membership function for this fuzzy set can be obtained as follows:

$$P(z) = \frac{0.35-z}{0.35}, \text{ for } 0 \leq z \leq 0.35,$$

$$= 0, \text{ otherwise,}$$

$$F(z) = \frac{z}{0.35}, \text{ for } 0 \leq z \leq 0.35,$$

$$= \frac{0.70-z}{0.35}, \text{ for } 0.35 \leq z \leq 0.70,$$

$$= 0, \text{ otherwise,}$$

$$G(z) = \frac{z-0.35}{0.35}, \text{ for } 0.35 \leq z \leq 0.70,$$

$$= \frac{1.05-z}{0.35}, \text{ for } 0.70 \leq x \leq 1.05,$$

$$VG(z) = \frac{z-0.70}{0.35}, \text{ for } 0.70 \leq u \leq 1.05,$$

$$= 1, \text{ for } z \geq 1.05, \text{ -----(10)}$$

Fuzzy Rule Base:

The selected If...and...then rules for quality of milk are presented as follows:

TC	FAT	Acidity	Quality of Milk	TC	FAT	Acidity	Quality of Milk
L	L	L	G	M	L	L	G
L	L	N	G	M	L	N	F
L	L	H	F	M	L	H	F
L	N	L	G	M	N	L	G
L	N	N	G	M	N	N	G
L	N	H	F	M	N	H	F
L	H	L	VG	M	H	L	G
L	H	N	VG	M	H	N	G
L	H	H	G	M	H	H	F
H	L	L	F	VH	L	L	F
H	L	N	F	VH	L	N	F
H	L	H	F	VH	L	H	P
H	N	L	G	VH	N	L	F
H	N	N	F	VH	N	N	F
H	N	H	F	VH	N	H	P
H	H	L	G	VH	H	L	G
H	H	N	G	VH	H	N	G
H	H	H	G	VH	H	H	P

Example: If u=7 and x=6.5 and y= 0.12 then z= 0.7. i.e. if TC is MEDIUM and FAT is NORMAL and Acidity is NORMAL then quality of milk is GOOD.

**Conclusion**

In this study 36 rules are prepared to form a rule base. Using Mamdani method and Mean of Maximum defuzzification method, it is observed that FCT can be used for determining quality of themilk. The quality of milk can also be determined by increasing the number of input parameters for more realistic model. Some different t-norms can be used for more effective control.

**References**

1. Da Ruan: Fuzzy Set Theory and Advanced Mathematical Applications Kluwar Academic Publishers. (1995)
2. George J.Klir and Bo Yuan: Fuzzy Sets and Fuzzy Logic: Theory and Applications, Prentice-Hall of India. (2000)
3. George Bojadziev and Maria Bojadziev: Fuzzy Logic for Business, Finance and Management, Second Edition, World Scientific.
4. H.J.Zimmermann: Fuzzy Set Theory and its Applications (1995)
5. H. J. Zimmermann, Fuzzy Sets, Decision Making and Expert Systems, Kluwer Academic Publishers, Bosten, (1987).
6. John Yen, Reza Langari: Fuzzy Logic Intelligence, Control & Information, Pearson(1999)
7. Kai Michels, Frank Klawonn, Rudolf Kruse, and AndreasNurnberger: Fuzzy Control: Fundamentals, Stability and Design of Fuzzy Controllers, Springer International
8. Kwang H. Lee: First Course on Fuzzy Theory and Applications, Springer International Edition (2005)
9. M. S. Bapat and S. N. Yadav. Fuzzy sets in Sugarcane Industry Decision, International Journal of Tropical Agriculture 27, No. 1-2 (Jan-June (2009)
10. MamdaniE.H.:“Advances in the linguistic synthesis of fuzzy controllers” Intern. J.of Man-Machine Studies 8(6) p.p. 669-678.(1976)
11. M.Ganesh: Introduction to Fuzzy Sets and Fuzzy Logic, PHP (2012)

12. R. H. Bosmaetal., Assessing and Modeling Farmers Decision Making on Integrating Aquaculture into Agriculture in the Mekong Delta.
13. R. J. Clemen, T. Relly, Making Hard Decision: An Introduction to Decision Analysis, 2<sup>nd</sup>ed., Duxbury, Pacific Grove, CA, (1996).
14. R. R. Yager and D. Basson, Decision Making with Fuzzy sets, Decision Science, 6, (1975).
15. Sugeno M. : Industrial Applications of Fuzzy Control, North Halland New York.(1995)
16. S. Chen and C. Hwang, Fuzzy Multiple Attribute Decision Making, Springer Verlag, Berlin, 1992.
17. Toshiro Terano, KiyojiAsaiMichioSugeno: Applied Fuzzy Systems (1994).



## Relativistic Magneto – Dust Distribution and A Group of Conharmonic Conformal Motions

**S. S. Patil**

Department of Physic  
Shri Vijaysinha Yadav Arts and Science College,  
Pethvadgaon

**D. B. Patil**

Department of Mathematics  
Shri Vijaysinha Yadav Arts and Science College,  
Pethvadgaon

### Abstract:

*The several properties of Magneto – Dust distribution admitting a group of cohormonic conformel motions are derived.*

*Keywords: The stress energy tensor, Conharmonic Conformel motions, field equations, general relativity.*

### Introduction:

One of the recent symmetries known as conformal symmetry plays a key role in obtaining space – time model for relativistic distributions of matter. This symmetry consists of both the earlier symmetries, namely isometry and self similarity (Taub 1971, Eardly 1974, Wilson 1986).

The conformal symmetry property has been an essential geometric prescription for a good part of physics (Duggal 1989). The conformal invariance is the root of twisstar programme.

The aim here is to examine the effect of conformal motion on the dynamical structure of relativistic Magneto – Dust Distribution.

### Implications of Conformal Motions:

The necessary condition for conformal motion is

$$\xi_{\alpha\beta} = 2\psi \square_{\alpha\beta} \quad \text{i.e. } \xi_{\alpha\beta} + \xi_{\beta\alpha} = 2\psi \square_{\alpha\beta} \quad 2.1$$

Case i) Let us choose  $\xi = u$ , equation 2.1 becomes,

$$u_{\alpha\beta} + u_{\beta\alpha} = 2\psi \square_{\alpha\beta} \quad 2.2$$

On contracting (2.2) with  $\square_{\alpha\beta}$ , we obtain,

$$\theta = 4\psi, \quad (u^b_{;b} = \theta) \quad 2.3$$

Transvection of (2.2) with  $u^a u^b$ , yields

$$\psi = 0, \quad (u_{\alpha\beta} u^{\alpha} = 0) \quad 2.4$$

$$\text{From equation (2.3), } \psi = 0 \quad 2.5$$

Equation (2.4) implies that conformal killing vector is change of to killing vector.

On contracting (2.2) with  $u^a h^b$ , we obtain

$$\dot{u}_b h^b = 0 \quad 2.6$$

Further transvection of (2.2) with  $h^a h^b$  gives

$$2h^a h^b u_{\alpha\beta} = -2\psi h^2 \quad 2.7$$

$$\text{This gives } 2h^a h^b u_{\alpha\beta} = 0 \quad \text{vide(2.4)..} \quad 2.8$$

By using (2.6) in Maxwell's equation

$$\mu[h^2\theta + \frac{1}{2}(h^2)^{\cdot} + u_{\alpha\beta} h^a h^b] + \dot{u}h^2 = 0$$

We get,

$$2\dot{\mu}h^2 + \mu(h^2)^{\cdot} = 0 \quad \text{vide (2.4)} \quad 2.9$$

The continuity equation  $\dot{\rho} + \rho\theta - \frac{1}{2}\dot{\mu}h^2 = 0$  with (2.4) provides

$$\dot{\rho} = \frac{1}{2}\dot{\mu}h^2 \quad 2.10$$

Therefore  $\rho$  is invariant iff  $\mu$  is invariant along flow lines.

**Case II:** Let us choose  $\zeta = h$ ,

For this choice equation (2.2) takes the form

$$h_{\alpha;b} + h_{b;\alpha} = 2\psi g_{\alpha b} \quad 2.11$$

On contracting (2.11) with  $\square^{ab}$ , yield

$$h^b{}_{;b} = 4\psi \quad 2.12$$

Further contracting (2.11) with  $u^a u^b$ , we get

$$4h^a{}_{;a} u^a = 4\psi \quad 2.13$$

Also multiplying (2.11) with  $h^a h^b$ , we get

$$\frac{L}{h} h^2 = 2h^2 \psi \quad 2.14$$

On contracting (2.11) with  $u^a h^b$ , we get

$$u_{\alpha;b} h^a h^b - h^a{}_{;b} h_{\alpha} u^b = 0 \quad 2.15$$

Hence from (2.15) and Maxwell equation

$$\mu [h^2 \theta - h^a{}_{;b} h_{\alpha} u^a + u^a{}_{;b} h_{\alpha} h^b] + \dot{u} h^2 = 0$$

We have

$$\dot{\mu} + \mu \theta = 0 \quad 2.16$$

We know continuity equation, viz

$$\dot{\rho} + \rho \theta = \frac{1}{2} \dot{\mu} h^2$$

But  $\dot{\mu} = -\mu \theta$

Hence above continuity equation becomes,

$$\dot{\rho} + \left( \rho + \frac{1}{2} \mu h^2 \right) \theta = 0$$

$$\Rightarrow \dot{\rho} = 0 \quad \Leftrightarrow \quad \dot{\mu} = 0 \quad \left( \theta = -\frac{\dot{\mu}}{\mu} \right)$$

If magnetic field vector  $h$  is the conformal killing then we get

$$\psi = 0, \quad \rho = \frac{3}{2} \mu h^2 \quad 2.17$$

**Case III:** Let us choose  $u = h = \xi$  be conformal killing vectors then we have following results.

$$\theta = 0 \quad 2.18$$

$$\psi = 0 \quad 2.19$$

$$\sigma = 0 \quad 2.20$$

$$\frac{L}{h} h^2 = 0 \quad 2.21$$

$$\dot{\rho} = 0 \quad 2.22$$

$$\dot{u} = 0 \quad 2.23$$

$$\mu (h^2)^{\cdot} = 0 \quad 2.24$$

$$\dot{\mu}_{\alpha} = 0 \quad 2.25$$

$$h^b{}_{;b} = 0 \quad 2.26$$

### Conclusions:

When the time like flow vector  $u$  and magnetic field vector  $h$  both are conformal killing then we have

1. Flow lines are expansion free, shear free and geodesic. vide (2.18),(2.20),(2.25)
2. Magnetic lines are divergence free. vide (2.26)
3. Matter energy density is conserved along  $u$ .vide (2.22)

### References

1. Lichnerowicz, A. (1967): Relativistic Hydrodynamic and Magneto hydrodynamic, W.A.Benjamin, INC, Newyork.

2. Eric A Lord (1976): Tensor Relativity and Cosmology, TataMcGraw-Hill.
3. Ray, M.A.and Banarji, S. (1980): Pro.of 9<sup>th</sup> Annual Conference of Indian Association of GRG., P.193





**Biodiversity of Aquatic Animals Alni Dam at. Alnigaon, Distric.  
Osmanabad Maharashtra India**

**Satish Patil.**

Shri Jagdish Prasad Jhabarmal Tibrewala University,  
Dist. Jhunjhunu, Rajasthan

**H.K .Jadhav**

Prof, and HOD. Dept. of Zoology A.S.C.College  
Naldurg(MS).

### Abstract

*This Dam Located On 18.2816o North and 76.0102o East Tahsil and District. Osmanabad (M.S.) India Constructed in 1972. It is a natural Dam and with a large source of Aquatic Animals including , certain protozoans Molluscans Arthropods other animals and aquatic plant, which are commercially important to man and environment. This dam is also for drinking and irrigation water for nearly about irrigation and domestic etc. The present investigation was carried out to study biodiversity of certain aquatic animals with reference to Arthropods , Protozoans , Molluscans from Alni Dam water body during the period from Oct 2017 to Nov 2018, One year . The Result were confirmed the occurrence of the species and one Genus belongs to one order of protozoa, 3 species and 3 genus belongs to 3 Order of Molluscan , 7 species and 6 genus belonging to 4 order of Arthropods . The Result shows with rich biodiversity of aquatic Animals.*

*Keywords: - Biodiversity of aquatic Animals Fishes , Arthropods , Protozoans, and Molluscans in Alni Dam.*

### Introduction

The Dam was constructed by 1972 for impounding effective utilization of water for irrigation, power generation and food control . India is having very rich sources of inland water bodies in the large number of living aquatic animals , which are economically important for nature as well as human being for their using as a food these are provided an excellent food with high protein , fats , carbohydrates and vitamins and certain minerals which are inhabit of river, lakes and dam their distribution is directly related to availability of food and quantity sediment type there are certain organism or macrobenthon and play important role in the mineralization and recycling of organic matter and as a link in the energy flow from primary production to fish and other aquatic animals . The considerable studies on Biodiversity and diversity of aquatic animals from different water bodies of India . have been carried out during the last few decades , Krishnamurthy 1966 Anitha et, al.(2004). made the (1981), Gupta (1976), The more important work on this aspect is those of srivastava(1959), Michal(1964).

### Materials And Methods

The aquatic animals were collected from the Alni dam with the help of local fisher man by using different types of net and also with help of hand , after noting down colour and other morphological features . These animals were cleaned with clean warm water to remove stem of micro- organism and blood stain . The animals were preserved 5% formal solution for further study and systematic identification of animals was done with the help of standard literature . the various aquatic animals and identification of arthropods and Protozoans was done by using standard tests and keys Edmondson 1959. The molluscan were identified with the help of key given by earlier research works Batt(1959). The various aquatic animals and fishes were identified with the help of following key of Ward and Whipple (1959), Hamilton (1878), Jayaram (1981), Talwar and Jhingran (1988). Khanna(1992).

### Result And Discussion:-

The distribution of aquatic animals are quite variable because of geographical and geological of water body . the aquatic ecosystem is an important and having large number of aquatic animals which are ecologically important including . Protozoan's , Molluscan's crustaceans , insects and fish . The present result has confirmed the occurrence of protozoan's with , 1 species belong to 1 order and , 1 genus. Molluscan with 3 species belongs to 3 order and 3 genus. Arthropods with 7 species belonging to 4 order and 6 genus during the Oct 2017 to Nov 2018 check list 1, 2 , and 3 the result show with rich biodiversity of aquatic animals including , prawns , crabs other crustaceans , insect , gastropods , Bivalvia.

## 1. Clesk List Of Arthropods From Alni Dam During Period Oct 2017 To Nov 2018.

Phylum – Arthropods

Sub- Phylum - *mandibulata*Class -*crustacean*.Sub- class- *malacostraea*.Order –*mysidacea*.Genus – *mysis*.Order- *Decopoda*Genus –*malcolmsoni, rosenbergii*Species – *palaemon*Genus *Barytelphusa*.Species – *guerini, cunicularis*.

Order – Nebaliacia .

Genus – *nebalia* .Class – *insect- hexupoda*Sub – class -*pterygata*.Order - *hemiptera*

## 2. Clesk List Of Protozoon's From Alni Dam During Period Oct 2017 To Nov 2018.

Phylum – Protozoon's

Sub – phylum – *ciliophora*.Supper class – *ciliate*.Class – *ciliata*Sub- class – *hymenostomtids*.Species – *caudatum*

## 3. Clesk List Of Mulluscan's From Alni Dam During Period Oct 2017 To Nov 2018.

Phylum – Mulluscan's

Class – *gastropod*Sub – class – *prosobranchiate*.Order – *phenctinibranchita*.Genus – *pila*.Species – *globosa*.

Sub – class – Euthyneura.

Order – *pulmonata*.Genus –*lymnaea(fresh water snail)*Species- *limnaea*.

Class- pelecypoda

Order – *Eulamellibranchiata*.Genus – *lamellidens*.Species – *marginalis*.Genus- *Nepa or water scorpion*.Genus – *ranatra or water (stick insect)*

The study and sarvey of aquatic fauna of an aquatic water body os useful for planning of fish. these species of aquatic animal were shows variations during different seasons of the year. The Large number of protozoan's crustaceans and insect including palaemon species ,shrimps,mysis carb barytphesa species was recorded ,during mansoon rain season and also constant recorded year but not in November month while molluscans and fishes was recorded throughout the but maximum after monsoon season .the mollusan species like sanils, pila ,globosa species was recorded largely during monsoon month and few in winter and summer month while freshwater mussels or lamellidens marginalis or unio was recovered maximum winter and summer month and less in monsoon months satyamurti (1998)were recoredmolluscan diversity reveled the occurrence of 450 species of gastropods and 156 species Bivalvia .Devraj (1998)were recored 100 species of

gastropods .sharma et.al. 2010 were reported a total 16 species of mollusacs from omkareshwar region out of which of belonged to pelecypoda and 7 to gastropod from narnada River ,madhy Pradesh.

### References

1. **Anita G. Kodarkar M.S. Chandrsekhar S.B.A. And Grace Nalini (2004).** Studies on macro – zoobenthos ,Mir Atam lake Hyderabad ,Andhra Pradesh .j.aqua.biol.1991): 61-68.
2. **Sharma and devendra Mohan (2010).** Fish fanul diversity of hemawas dam ,pali ,rajsthan .j.aqua .biol.25(2):37-40.
3. **Devraj M. (1998).**conservation and sutainable of marine living resource of the gulf of manner marine biosphere Reserve.prov.tech.workshop held at channi Feb 10.11,128-149.
4. **D.Annadurai (2006).**Gastropods diversity of the Gulf of Manner Marine Biosphere Reserve.Tamil Nadu,India .j.aqu.Biol.21A(1) :49- 52.
5. **Edmondson W.T. (1959).** Rotifera in fresh water biology ed.w.t.Edmondson ,John weily asons Inc.New York,Londan 420-494.
6. **Jayaram K.C. (1981)** .the fresh water fishes of India ,A handbook ,Z.S .I. Kolkata ,india .
7. **Jayabhay U.M. and G.D. Khedkar (2008).** Fish diversity od sawana dam in Hingoli dist. Of Maharashtra .j.aqualbiol.12(10 26-28.
8. **Kannan L. and C. Govindaswamy (1995).**rotiferas of portonovo center of advanced study in marine Biology Annamalai university ,portonova,Tamil Nadu ,India 49p.
9. **Kamble S.M. Mohekar A.,D. and Bhagwan H.K.(2006)** . biodiversity of manjra near kallam ,dist osmanabad( M.S.)india j.aqua.Biol.21(3): 3-4.
10. **Srivastava V.K. (1959).**Studies of freshwater funa II qualitative composition and variation of the available food supply of fishes.proc.nat. Acad.sci.India .29:207-216.
11. **Sharma ,shailendra L.K. ,Mudgal zahoopir and Imtiyuz toil (2010).**Distribution of mollusacn biodiversity in Marmada river ,Madhya Pradesh .j.aqua. Biol.25 )2) 30-33.
12. **Shrikant K. ramu G. and Benarjee G. (2009).**The study on this diversity of Rammapa lala, waragal ,Andhra Pradesh .j.aqua.Biol.24.(2) 57-60.
13. **Talwar P.K. and Shingram A.G. (1991).**Inland fishes of india and Adjacent countries vol.1and 2 Oxford and IBH publication Co.Pvt.Ltd .
14. **Ward H.B.and Whipple .C. (1952)** .Fresh water bilyog ,John wiley and sons ,New York.

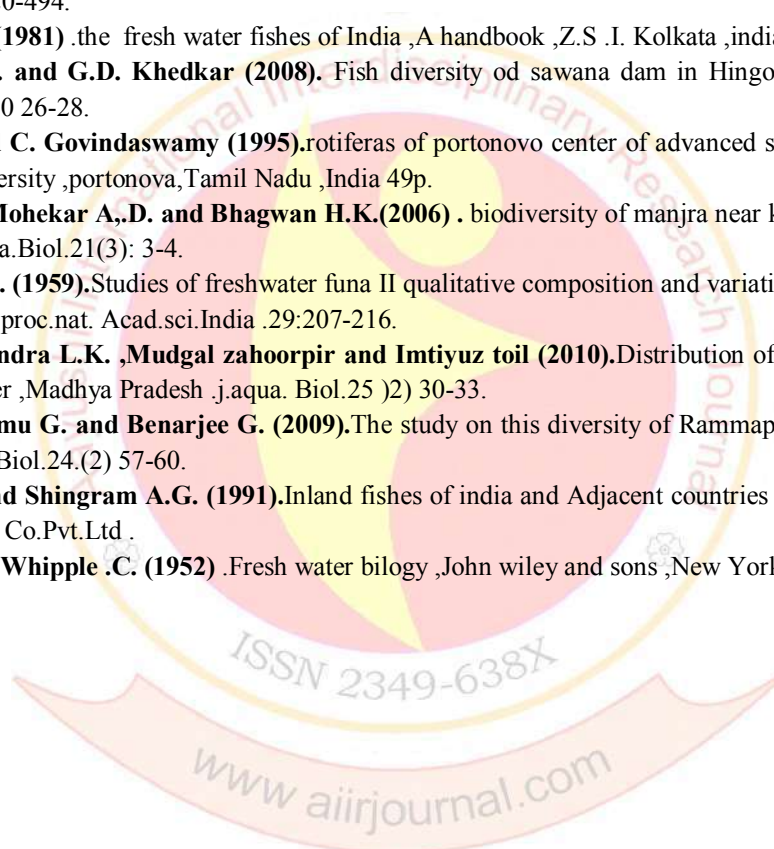

## Effect of liquid Biofertilizer on Maize (*Zea mays L.*) production- agronomical tool for sustainable Environment

**Miss. Supriya P. Kusale**

Research scholar, Department of  
Microbiology, Rajaram College, Kolhapur

**Dr. Yasmin. C. Attar**

Associate Professor, Department of  
Microbiology, Rajaram College, Kolhapur

### Abstract:

This study was conducted to investigate the effect of Phosphate processing klebsiella spp (N6) on the growth and development of maize (*Zea mays*) plants. Inoculum prepared from *Klebsiella* spp was applied to the field in two different treatments. The first one was performed by inoculating the soil with prepared inoculum at the concentration at 500ml/acre. The second treatment was conducted by treating the plot with 1lit/ acre inoculum. We compared these two types of treatments to determine which one has more benefit for improving the growth of maize plants. Results obtained revealed that the application of *Klebsiella* spp caused increases in all measured parameters which include growth parameters, chlorophyll content, starch content, total protein content and phytohormones content of maize plants, when applied to the soil as compared to Control plot. But the magnitude of these increases was much more pronounced in case of plants developed from 2<sup>nd</sup> treatment with concentrations at 1lit/acre.

Keywords: Liquid Biofertilizer, *Klebsiella*, Maize, Field trails.

### 1. Introduction

Soil microorganisms play important role in regulation of carbon, Nitrogen, Phosphorous, Sulfur cycles in soil atmosphere by solubilizing the macro as well as micro elements in various ways. Microorganisms are important in agriculture in order to promote the circulation of plant nutrients and reduce the need for chemical fertilizers as much as possible. Organic agriculture is one of the ways that can produce high quality crops (Zarabi, Alahdadi et al. 2011). This aspect of micro organisms is exploited for plant growth and development in agriculture for Biofertilizer production. Application of beneficial microbes in agricultural practices started 60 years ago and there is now increasing evidence that these beneficial microbial populations can also enhance plant resistance to adverse environmental stresses, e.g. water and nutrient deficiency and heavy metal contamination (Shen 1997). Phosphorus (P) is an essential macronutrient for plant growth. Despite phosphorus being widely and abundantly distributed in the soil in both its inorganic and organic forms, many soils throughout the world are deficient in phosphorus. Phosphorus can be tightly bound with calcium, iron, or aluminium, leading to precipitation of phosphorus (Guang-Hua, Jian et al. 2007). Liquid Biofertilizer is an alternative for chemical and organic fertilizers. As compared with solid carrier based Biofertilizer, liquid base product is much more beneficial in many aspects. Mainly it is less costly because it saves huge expenditure on bulky carrier and its sterilization process. Its application is easy so it became popular among the farmers. Shelf life of cells in liquid inoculums is higher than carrier based Biofertilizer. Phosphate (P)- and potassium (K)-solubilizing bacteria may enhance mineral uptake by plants through solubilizing insoluble P and releasing K from silicate in soil (Goldstein and Liu 1987). Simultaneous screening of rhizobacteria for growth and yield promotion under pot and field experiment is a good tool to select effective PGPR for biofertilizer development biotechnology (Gholami, Shamsavani et al. 2009). It has also been reported that wheat yield increased up to 30% with *Azotobacter* inoculation and up to 43% with *Bacillus* inoculation (Zablotowicz, Tipping et al. 1991).

Maize (*Zea mays L.*) is the third most important globally cereal crop (after wheat and rice), it is grown throughout a (Pingali 2001) wide range of climates.

The present study was undertaken to assess the effect of on growth and yield of two maize cultivars and to determine the optimum level suitable for improving maize production

There fore considering the above facts, this study aims to assess the effect of different concentrations (doses) of liquid biofertilizer prepared by *Klebsiella* sp. had additional and promoting effects on vegetative growth through the analysis of some indicating factors, such as germination rate, root elongation, plant height, and fresh weight of the plants as well as fruit yield.

## 2. Material And Methods

### 2.1. Plant material

Grains of *Zea mays* L. cultivar Ganga 11, maize used in this investigation was obtained from the local market, Kolhapur, Maharashtra (India).

### 2.2 Bacterial inoculum preparation

*Klebsiella spp* (N6) isolate selected for this study was previously isolated from soil. It was checked for PGPR activities and there fore choose for identification and field trials. Cell suspensions of *Klebsiella spp* (N6) was prepared by culturing the bacteria in nutrient medium at 25°C for 3 days. The cell density was counted by SPC method.

### 2.3. Field trial of prepared Biofertilizer-

A field trial was conducted from January to April, 2017-18.

Name of the farmer - Mr. Nagendra J Bedkale

Place - Chinchwad, Kolhapur.

Area - 27 Gunte

Maize grains were collected and washed for several times with water then divided into three groups as follows:

Test 1 - The 1st group was left without any treatments and served as the control plants

Test 2 - The 2nd group represented the seeds grown in soil inoculated with the 500ml/acre inoculum of *Klebsiella spp* (N6).

Test 3 - The 3rd group represents the seeds grown in soil inoculated with the 1lit/acre inoculum of *Klebsiella spp* (N6).

#### 2.3.1. Soil characteristics -

Before the field trial, initial soil samples were collected at five randomly selected spots to a depth of 0-30 cm from the experimental field. The soil was air dried ground and passed through 2 mm sieve for physiochemical soil analysis.

#### 2.3.2. Experimental details

The Maize cultivar used in the study was Ganga 11. It is long fruited pungent variety with duration of 240 days. Its average yield potential is 95-100 q ha<sup>-1</sup> under normal conditions.

The experiment was laid out in a three treatment plots.

Test 1 plot is kept as control in which Only Recommended Dose of Fertilizer (RDF) is given. However Test 2 plot the dose of RDF was reduced by 50% with addition of Biofertilizer with 500ml/acre. Test -3 plot with dose of 50% RDF with addition of biofertilizer 1lit/acre.

### Application of Recommended Dose of Fertilizer and Manures with Biofertilizer

FYM – 25 t ha<sup>-1</sup>

NPK – 100 – 50 – 50 kg ha<sup>-1</sup> (Urea, Single super phosphate and potash respectively).

Subsequent irrigations were given at every 7-10 days interval depending upon the soil moisture status and weather condition. The experimental area was kept weed free throughout the cropping period by manual weeding. Necessary plant protection measures were taken during the crop period to control pests and diseases.

#### 2.3.3. Application of Biofertilizer

The prepared Biofertilizer of *Klebsiella spp.* was applied through drenching by mixing with water as per experimental plot design for 3 times with equal time gap at 15, 30 and 45 days.

#### 2.3.4. Harvesting

The crop was first harvested after 115 days after transplanting. Harvesting was done on the basis of colour and maturation stage of fruits.

#### 2.3.5. Observations recorded

Ten plants were selected randomly in each plot and observations were recorded on growth and yield parameters.

##### 2.3.5.1. Plant Height (cm)

The height of the plant from base to the tip of the main branch was measured with meter scale from selected plants in each replication of the treatment plot at 30, 60, 90 days after transplanting (DAT) and their averages were recorded and expressed in centimeter (DHONDE 2014).

### 2.3.5.2. Number of Primary leaves

The leaves arising from main stem were counted at 30, 60 and 90 days after transplanting (DAT) from selected plants in each replication of the treatment plot and their averages were recorded and expressed as number per plant (Neha 2015).

### 2.3.5.3. Total Dry Weight of the Plant (gm)

Total dry weight of the plant was recorded by uprooting two randomly selected plants from sample rows in each plot at 1st picking. The samples were dried in hot hair oven at  $65 \pm 2^\circ\text{C}$  till constant weights were obtained and their averages were recorded.

### 2.3.5.4. Number of Fruits per Plant

Harvesting of fruits was done in 1 picking. The total number of fruits from all the area was calculated for average yield.

### 2.3.5.5. Weight of total seeds of individual fruit (gm)

The fresh weight of the individual fruit seeds was obtained by weighing the all seeds of per fruit.

## 3. Result And Discussion -

### 3.1. Production of Biofertilizer

By using *Klebsiella spp.* production of liquid biofertilizer was carried out and used for application in field trials.

Cell count of prepared biofertilizer was  $10^8$  cfu/ml and O.D  $\sim 1$  at 600 nm and  $P^H$  was 6.3

### 3.2. Field trials of prepared Biofertilizer-

#### 3.2.1. Soil characteristics -

The soil of the experimental plot was sandy clay loam with good drainage condition.

#### 3.2.2. Growth characters

##### 3.2.2.1. Plant Height (cm)

The data on plant height at 30, 60, 90 DAT (Days After transplanting) is presented in the graph 3.5.2.1 are indicating that there were significant differences at all stages of crop growth. There was continuous increase in plant height from 30 DAT to 90 as compared to control. On 90 DAT the height was maximum 230cm in TEST 2 plot.

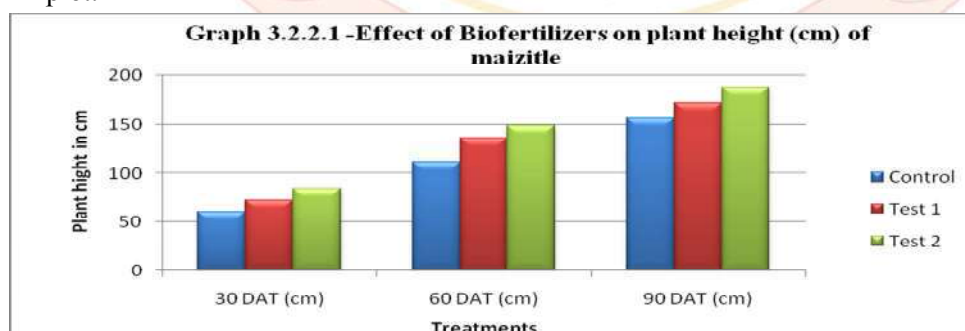

\*DAT: Days After Transplanting

##### 3.2.2.2. Number of leaves

The total numbers of leaves were also significantly influenced by the use of biofertilizers at all stages of crop growth. At 90 DAT No. of leaves was more in TEST 2 plot than Control and Test 1.

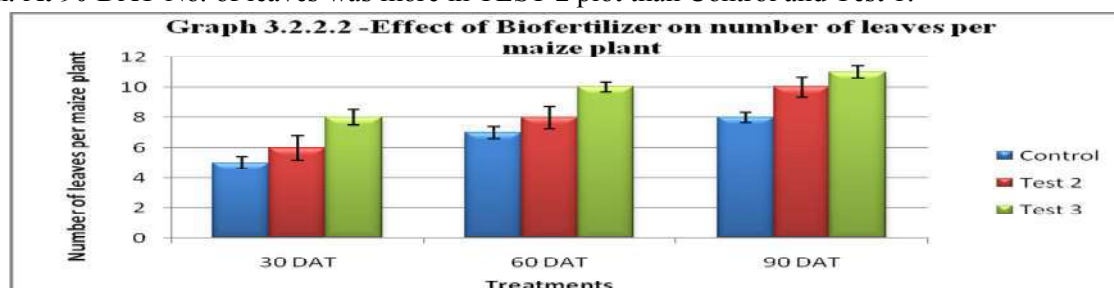

### 3.2.2.3 Total Dry weight of Plant (gm)

The data on dry weight of plant showed significant differences in Test as compared to Control plot it is also due to increase in height and number of leaves of plant which is increased by use of prepared biofertilizer. Maximum dry weight observed 163gm was recorded in the t Test 2 plot whereas in Control plot it was recorded the lowest dry weight i.e. 119 gm per plant.

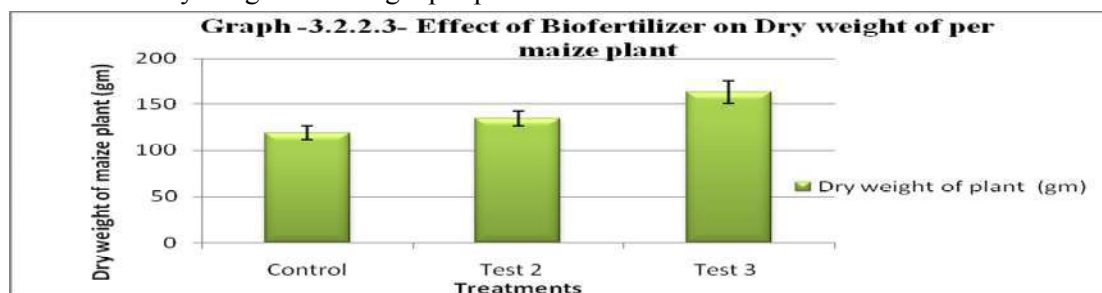

Yield parameter-

### 3.2.2.4. Number of Fruits per Plant

Use of biofertilizer significantly influenced the number of fruits per plant during the crop period (Graph 3.5.2.4) Maximum number of fruits per plant was observed in Test 2 whereas in Control plot recorded lowest number of fruits per plant.

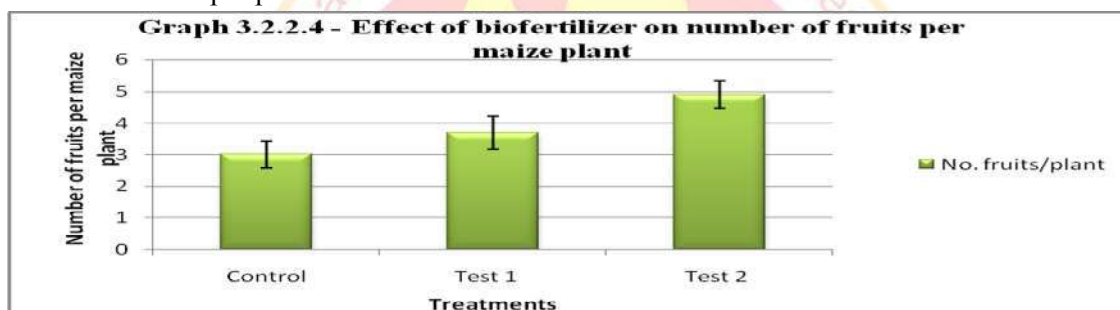

### 3.2.2.5. Weight of Individual Fresh Fruit seeds (gm)

Use of biofertilizer significantly influenced the weight of total seeds of fruit (gm) (Graph 3.2.2.5). The plot Test -2 recorded maximum fruit weight ( 205 gm) while Control plot recorded the minimum fruit weight ( 151 gm). This affect the total yields due to increase in weight as well as number of fruits per plant.

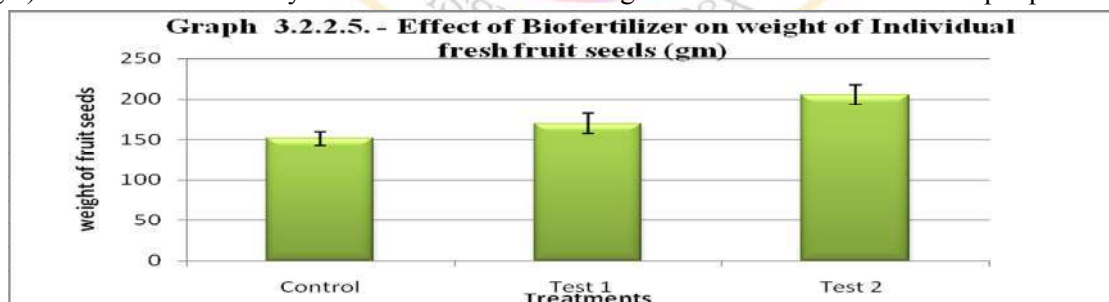

In general biofertilizer inoculation considerably increased the seedling plant height, and number of leaves therefore Number of fruits per plant and weight of fruit also increases as compared with Control plot. Therefore total yield of TEST 2 plot get increased where we used 1lit/ acre dose of biofertilizer.

The total yield of maize recorded in the Test 2 plot was 43 q and in Control plot it was 25 q which is lowest. In Test 1 plot the yield was average i.e 34 q Therefore gross income of the farmer in Test 2 plot is much higher which is than Control and Test 1 plot.

## 4. Conclusion

On the basis results of the present study it is clearly indicate the use of prepared biofertilizer using the *Klebsiella spp.* were highly beneficial for enhancing the yield of maize at the dose of 1 lit/acre and also cost effective. It has low the cultivation cost because we have reduced dose of Chemical fertilizers by 50%. And also due to increase in growth and yield parameters the total yield was increased. Therefore net income

of the farmer gets doubled. So we can conclude that the use biofertilizer prepared by using *Klebsiella spp.* is economical to farmers as well as eco-friendly for Environment.

### 5. Acknowledgement

We thankfully acknowledge the Principal Dr. Khemnar of the institute for providing necessary infrastructural facilities. First author thanks Head of the Department and research guide Dr. Mrs. Y. C. Attar for her support and time to time guidance and also thank Shivaji University for awarding Departmental Golden jubilee research fellowship for 2016-2018 which was helpful for financial support to research work.

### 6. References -

1. Dhonde, A. S. (2014). Intercropping Of Maize (*Zea Mays L.*)+ Cowpea (*Vigna Unguiculata*) For Higher Prouction Of Green Fodder, Mpkv, University Library Rahuri.
2. Gholami, A., S. Shahsavani, et al. (2009). "The effect of plant growth promoting rhizobacteria (PGPR) on germination, seedling growth and yield of maize." *Int J Biol Life Sci* 5(1): 35-40.
3. Goldstein, A. and S. Liu (1987). "Molecular cloning and regulation of a mineral phosphate solubilizing gene from *Erwinia herbicola*." *Bio/technology* 5(1): 72.
4. Guang-Hua, W., J. Jian, et al. (2007). "Inoculation with phosphate-solubilizing fungi diversifies the bacterial community in rhizospheres of maize and soybean." *Pedosphere* 17(2): 191-199.
5. Neha, S. (2015). Performance of weed management practices in kharif maize (*Zea mays L.*), Mahatma Phule Krishi Vidyapeeth, Rahuri.
6. Pingali, P. L. (2001). "CIMMYT 1999/2000 World maize facts and trends. Meeting world maize needs: Technological opportunities and priorities for the public sector."
7. Shen, D. (1997). "Microbial diversity and application of microbial products for agricultural purposes in China." *Agriculture, ecosystems & environment* 62(2-3): 237-245.
8. Zablotowicz, R. M., E. M. Tipping, et al. (1991). Plant growth promotion mediated by bacterial rhizosphere colonizers. *The rhizosphere and plant growth*, Springer: 315-326.
9. Zarabi, M., I. Alahdadi, et al. (2011). "A study on the effects of different biofertilizer combinations on yield, its components and growth indices of corn (*Zea mays L.*) under drought stress condition." *African Journal of Agricultural Research* 6(3): 681-685.

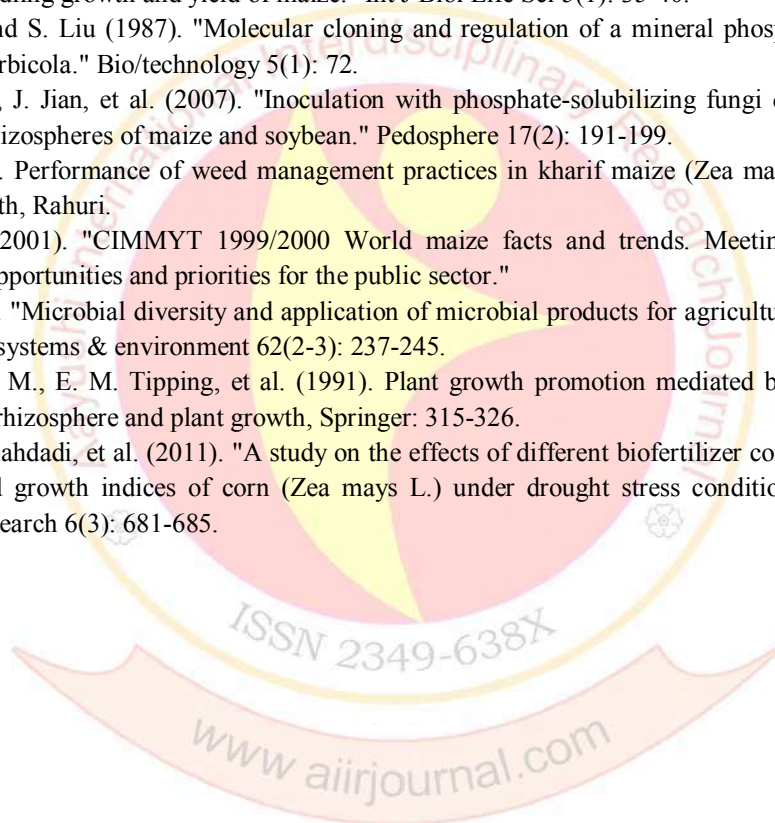



## Recovery of Multi applicative Copper Metal from Silver Jewellery Laboratory Effluent and Antibacterial, Fungicidal Activity of Effluent Modified Standard Copper Sulphate

Uttam Kadam, Mahesh Magdum, Suraj Patil, Prasad Kulkarni, Aniket Gaikwad, Satyanarayan Arde\*

Department of Chemistry, Y. C. Warana Mahavidyalaya, Warananagar, Kolhapur (MS, India)

### Abstract:

*The present work deals with the recovery of copper metal from waste sample of analytical laboratory of silver jewellery by electrolysis method. The collected highly acidic effluent neutralized and converted it in to copper sulphate. Obtained copper sulphate solution showed excellent antibacterial as well as antifungal activity against pathogenic bacteria and fungi respectively.*

**Keywords:** recovery of copper metal, copper oxide, copper sulphate, antibacterial activity, antifungal activity.

### Introduction

Elemental copper is very precious metal used in diverse fields such as building material, electricity, household utensils, micronutrients, in the preparation of metal alloys, sterling silver for jewellery, manufacturing of coins, strain gauges, thermocouples, etc. It is occurred in the nature in elemental form as well as in oxide, sulfide or salt form. It is ductile, malleable metal and it is easily into various shapes for use as wire, ornaments and implements of various types. Copper is the best electrical conductor it has good thermal conductivity. Due to its wide spread applications in day to day life, there is an immense interest in resource saving and it has raised the importance of metal recycling. There are different methods are available for the recycling of copper metal such as non-electrochemical method<sup>1</sup>, electrowinning<sup>2</sup>, hydrometallurgical and electrochemical processes<sup>3</sup>, electrolytic recovery<sup>4</sup>, etc. These technologies aim to recover heavy metals from waste water and to control environmental pollution. Among these methods electrolysis is the commonly used method for the recovery of a wide range of metals from industrial or analytical laboratory effluents. It concerns for a clean technology as electron is a clean reagent with main advantages the direct recovery of metals as pure material, the economic benefits that results from the avoidance of secondary wastes that contribute to environmental problems and demand additional treatment and the possibility to recycle the water in close procedures. On the other hand, a salt of copper such as copper sulphate is famous fungicide used in the agricultural field as Bordeaux mixture<sup>5</sup>.

The waste sample containing copper nitrate is thrown in environment without any treatment which is hazardous to living things. As it has no proper disposal treatment, it is responsible for water pollution leading to human health and aquatic health hazard. Therefore it is necessary to make proper disposal management or reuse by transforming it in to standard content. In the present work, the recovery of copper metal from waste sample of silver analytical laboratory by electrolysis is studied. The sample contained copper nitrate and nitric acid was converted in to copper sulphate. The standard copper sulphate showed best antibacterial and fungicidal activity against pathogenic bacteria and fungi which give us key aspect to study the effect of copper sulphate concentration to kill pathogenic bacteria.

### Materials and Methods

#### Materials

All the chemicals used were of analytical grade and obtained from Molychem. Waste sample containing copper nitrate solution were collected from Hupari, District Kolhapur (MS, India). All solutions were freshly prepared using double distilled water and kept at room temperature for further use.

#### Preparation of Chemicals

- 1. Sodium thiosulphate (0.05 N  $\text{Na}_2\text{S}_2\text{O}_3$ ):** 3.1 gm of Sodium thiosulphate were weighed by standard digital balance and dissolved in minimum quantity of distilled water and diluted up to 250 ml in standard flask. The resulting solution was of 0.05 N and kept at room temperature for further use.
- 2. Potassium iodide (10%):**  
10 gm of KI is dissolved in minimum quantity of water and diluted up to 100 ml in distilled water.
- 3. Preparation of Starch Indicator:** 1 g of starch (Corn) was taken in to 10 mL of distilled water, shaken well and poured in to 100 mL of boiling distilled water. It was stirred thoroughly and boiled for 1 minute then cooled and kept for further use at room temperature.

### Results and Discussion

$\text{Cu}^{++}$  ion has a specific property to librate equivalent amount of iodine on treatment with excess of KI from the neutral or weakly acidic solution. The amount of librated iodine obtained by maintaining said conditions is then determined by titrating known volume of sample solution using starch indicator.

### Determination of % of Copper in waste sample

For the determination of percentage of  $\text{Cu}^{++}$  ions in the collected waste sample,  $20 \text{ cm}^3$  of waste sample was diluted to  $250 \text{ cm}^3$  using standard flask. Standard solution was then transferred in to the beaker.  $25 \text{ cm}^3$  of solution pipette out in clean and dry Erlenmeyer flask. To this solution  $10 \text{ cm}^3$  10% KI solution and 2-3 $\text{cm}^3$  of starch indicator were added and the solution was titrated against 0.05 N  $\text{Na}_2\text{S}_2\text{O}_3$  solution till end point occur as blue to colorless. The process was repeated thrice and found out constant burette reading which is shown in table 1.

**Table 1: Observation Table**

Readings	Burette readings			CBR X $\text{cm}^3$
	I	II	III	
Final	0.8	0.8	0.8	} 0.8 $\text{cm}^3$
Initial	0.0	0.0	0.0	
Difference	0.8	0.8	0.8	

#### Calculation:-

$$1 \text{ cm}^3 \text{ 0.05 N } \text{Na}_2\text{S}_2\text{O}_3 \equiv 0.01229 \text{ g copper}$$

$$'X' \text{ cm}^3 \text{ 0.05 N } \text{Na}_2\text{S}_2\text{O}_3 \equiv 0.01229 \times 'X'$$

Now,

$$25 \text{ cm}^3 \text{ of diluted sample} = A = 0.01229 \times 0.8 \\ = 0.009832$$

$$250 \text{ cm}^3 \text{ Diluted sol of sample} = A \times 10 \text{ g of copper} \\ B = 0.009832 \times 10 = 0.09832$$

$$'W' \text{ g of sample} = B \text{ g of copper} \\ 100 \text{ g Sample} = 100 \times B / W \\ = 100 \times 0.09832 / 0.4 \\ = 24.58 \%$$

#### Recovery of Elemental Copper

##### Part A: Preparation of Copper (II) Hydroxide

100 ml of sample was taken in to clean and dry  $250 \text{ cm}^3$  of beaker containing magnetic stirrer and placed on a micro scale magnetic stirrer at room temperature. To this sample solution, carefully 6 M NaOH solution was added drop wise until the solution become slightly basic. A light blue precipitate of copper (II) hydroxide was formed and confirmed the litmus paper has actually changed from red to blue, rather than simply being colored blue by the blue precipitate.

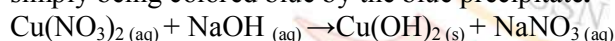

##### Part B: Preparation of Copper (II) Oxide

With constant stirring the copper hydroxide solution was heated at of  $110^\circ\text{--}115^\circ\text{C}$  temperature in oven. During this time, the copper (II) hydroxide is transformed into copper (II) oxide (Cupric oxide), which appears as a black precipitate. The obtained black precipitate was allowed to cool at room temperature. Further cooled black solid was isolated by suction filtration and dried for further treatment.

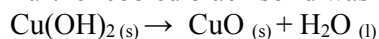

(Copper oxide is used as pigments in ceramics to produce blue, red and green. It is also used when welding with copper alloys)

##### Part D: Preparation of Copper (II) Sulphate Solution

Copper (II) oxide was converted in to Copper sulphate by adding 6 mL of 3M sulphuric acid in a black solid containing beaker. Solution was stirred with the glass rod till the black solid has completely dissolved. The resulting solution is of copper sulphate.

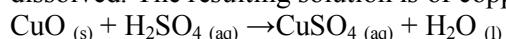

##### Part E: Electrolysis of Copper (II) Sulphate

Elemental copper can be obtained by electrolysis method by electrolyzing the standard solution of copper sulphate (Figure 1). The DC current was passed through the solution of copper sulphate present in the beaker by placing graphite rod in to it. Copper gets deposited on cathode (reduction) and oxidation took place at anode (oxidation). The deposited elemental copper on cathode (graphite rod) collected by scrubbing and weighed.



**Figure 1: Experimental setup for electrolysis of copper sulphate**

### Antibacterial Activity:

Standard copper sulphate (Part D) was screened for antimicrobial activity against pathogenic bacteria by using antibiotic sensitive assay of well diffusion method with a well size of 5 mm diameter and 0.2 g/mL of samples. Copper sulphate was highly effective in their antimicrobial activity against *Klebsiella pneumoniae*, *Pseudomonas aeruginosa*, *Escherichia coli*, *Staphylococcus aureus* and *Salmonella* than antibiotics. Penicillin antibiotic of 0.2 g/mL concentration was used as a control antimicrobial agent. The product formed in Part D, (copper sulphate) showed inhibition zone after 24 hours against all the studied bacteria and maximum zone of inhibition was found to be 33 mm in *Pseudomonas aeruginosa* and *Staphylococcus aureus* and minimum of 18 mm in *Pseudomonas aeruginosa* as shown in Table 2.

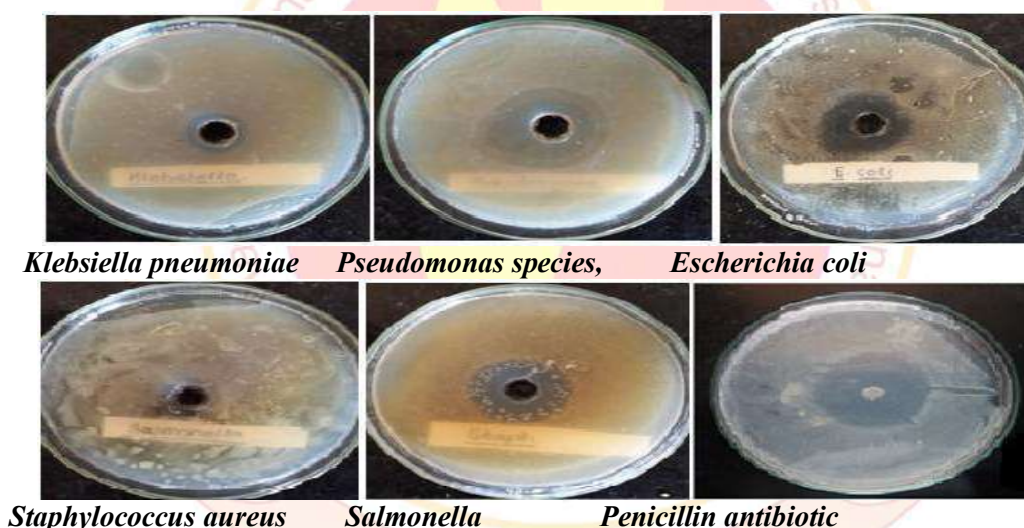

**Table 2:**

Name of the bacterial species	Zone of Inhibition (mm)	
	Copper Sulphate (0.2 g/mL)	Penicillin (0.2 g/mL)
<i>Klebsiella pneumoni</i>	20	12
<i>Pseudomonas aeruginosa</i>	33	
<i>Escherichia coli</i>	33	
<i>Staphylococcus aureus</i>	18	
<i>Salmonella</i>	31	

### Antifungal Activity

Copper sulphate is a fungicide used to control fungal diseases of fruit, vegetable, nut and field crops. Some of the diseases that are controlled by this fungicide include mildew, leaf spots, blights and apple scab. It is used in combination with lime and water as a protective fungicide, referred to as **Bordeaux mixture**.

### Conclusion

In conclusion, we have successfully recovered copper as in elemental form by electrolysis method. The present protocol is clean, non toxic, environmentally acceptable, renewable and low-cost for the recovery of copper metal. Collected solution of waste sample containing copper nitrate was converted in to standard copper sulphate solution and used as fungicide. The standard copper sulphate solution showed excellent antibacterial and antifungal activity against pathogenic bacteria.

### Acknowledgement

The authors are thankful to Principal, Yashwantrao Chavan Warana Mahavidyalaya, Warananagar, Kolhapur (MS, India) and Head, Department of Chemistry for providing necessary laboratory facilities. We are also very thankful to Dr. S. S. Gare, Head, Department of Microbiology, Shri Shiv-Shahu Mahavidyalaya, Sarud, (Kolhapur, MS, India) for providing antimicrobial and antifungal activity.

### References

1. Japan Oil, Gas and Metals National Corporation (JOGMEC), Kinzoku Shigen Report, **2015**, 3, 45.
2. Mitsuyasu Ogawa, Masahiro Kato, Masatoshi Majima, Tomoyuki Awazu, Hitoshi Yata, Masaharu Ooe, *SEI Technical Review*, Number 84, **2017**, 93.
3. R. Kammel, *The Minerals, Material and Materials Society*, **1991**, 777.
4. Ioanna Giannopoulou, Dimitrios Panias, Ioannis Paspaliaris, *Recycling and Waste Treatment in Mineral and Metal Processing: Technical and Economic Aspects*, 16-20 June, **2002**, Lulea, Sweden.
5. The Preparation of Bordeaux Mixture, Leaflet B, New York Agricultural Experiment Station, Geneva, N. Y., 1918.



## Design, Green Synthesis, Characterization And Antifungal Evaluation Of Novel Fluoro Imidazo [1,2-A] Pyridine Chalcones

Vikas D. Sonawane<sup>\*1</sup>, Babasaheb D. Sonawane<sup>2</sup>, Dipak P. Hiwarale<sup>3</sup> And Raghunath B. Bhosale<sup>\*1</sup>

<sup>1</sup>Organic Chemistry Research Laboratory, School of Chemical Sciences, Solapur University, Solapur - 413255, Maharashtra, India.

<sup>2</sup>Department of Chemistry, Karmaveer Bhaurao Patil Mahavidyalaya, Pandharpur.413304, Maharashtra, India

<sup>3</sup>Department of Chemistry, V. N. B. N. Mahavidyalaya Shirala, 415408, Maharashtra, India.

### Abstract:

*Hetero substituted Novel Fluoro Imidazo [1,2-a]-Pyridine Chalcones have been synthesized by Claisen–Schmidt condensation reaction using various heterocyclic acetyl ketones and 3-formyl-2-phenyl-fluoro imidazo [1,2-a] pyridine in PEG-400. First we have synthesized 3-formyl-2-phenyl fluoro imidazo [1,2-a] pyridine by oxidative coupling reaction using 2-aminopyridines and 4- fluoro cinnamaldehyde in presence of catalyst Copper bromide. The synthesized Novel Fluoro Imidazo [1,2-a]-Pyridine Chalcones are exhibiting with enormous biological activities like antifungal, antibacterial, antimicrobial, antianflammatory, antioxidant, analgesics, anticancer, antitumour, antituberculosis etc. The structures of the compounds were characterized by IR, <sup>1</sup>H NMR and screened for their in vitro anti-fungal activity compared to A.niger. Remarkable results were obtained for antifungal activity of the chalcone compounds 5c, 5d, 5e and 5f using standard drug.*

*Keywords: 3-formyl-2-phenyl-fluoro Imidazo [1,2-a] pyridine, PEG-400, Fluoro Imidazo [1,2-A]-Pyridines Chalcones and Antifungal activity.*

### Introduction:

Our main intention on preface in the molecular framework, for synthesizing active molecules having wide range of structural composition in joining of two heterocyclic different frameworks so as to achieve excellent summary in biological evaluation of the newly synthesized derivatives. So, we have planned to synthesize some new chalcones containing heterocyclic compounds like Pyrrole, Furan, Thiophene, Pyridine, Indole and Quinoline moieties in fusion with fluoro imidazo [1,2-a] pyridine moiety with hope which may possess a wide range of pharmaceutical evaluation. Imidazo[1,2-a]pyridine moieties represent important building blocks in both natural and synthetic bioactive compounds, which have been shown to possess diverse therapeutic activities<sup>1-3</sup>.

Imidazo[1,2-a]pyridine is one of the medicinally important fused heterocyclic scaffold used in the synthesis of Imidazo[1,2-A]-Pyridines derivatives used to cure various diseases as an important pharmaceutical drug. Design and synthesis of new compound with appropriate therapeutic importance is a major challenge in medicinal chemistry. This framework has been used as antifungal, antibacterial, herbicides, anti-inflammatories, antimicrobial, antitumor and anticancer. Imidazo[1,2-A]-Pyridines compounds have broad scope to synthesize large number of new chemotherapeutic agents and these are used in remedying new compounds which are useful in scientific medicines as drugs. Intensively a great idea has been developed behind the synthesis and biological activities of the condensed Imidazo[1,2-A]-Pyridines have been reported. In the present study, we have synthesized 3-formyl imidazo[1,2-a]pyridines in one step by aerobic oxidative coupling of 2-aminopyridines with cinnamaldehydes in presence of CuBr catalyst<sup>4</sup>.

Chalcones contain two aromatic rings with an unsaturated chain in which two aromatic rings are joined by a three-carbon  $\alpha$ ,  $\beta$ -unsaturated carbonyl systems as shown in following figure 1 - Structure of Chalcone. Structurally, being double bond in chalcone results in *cis* and *trans* isomeric forms of which the *trans* form is thermodynamically stable.

In organic synthesis, reactions carried out in aqueous medium play an important role for a hygienic synthetic procedure. A number of reactions in water medium has been reported earlier.<sup>5-7</sup> Reaction using PEG as solvent involves a clean procedure and avoids use of harmful organic solvents. Several investigations were conducted on the synthesis of the imidazo [1,2-a] pyridine ring systems. But instead of using water, we have carried out synthetic reaction in polyethylene glycol, PEG-400, as green solvent, economical, easily accessible, thermally stable, recyclable, biological comfortable, nontoxic.<sup>8-11</sup> Our synthetic work turns intention towards foreword of chemical multiplicity in the molecular framework, to synthesizing active

molecules having broadly different heterocyclic frame works to achieve good bioevaluation of the newly synthesized chalcone derivatives as Shown in Figure 2- Fluoro Imidazo [1,2-A]-Pyridine Chalcones ( 5a-f).

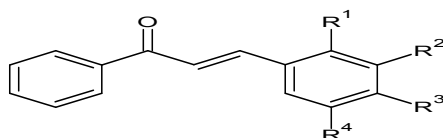

Figure 1- Structure of Chalcone

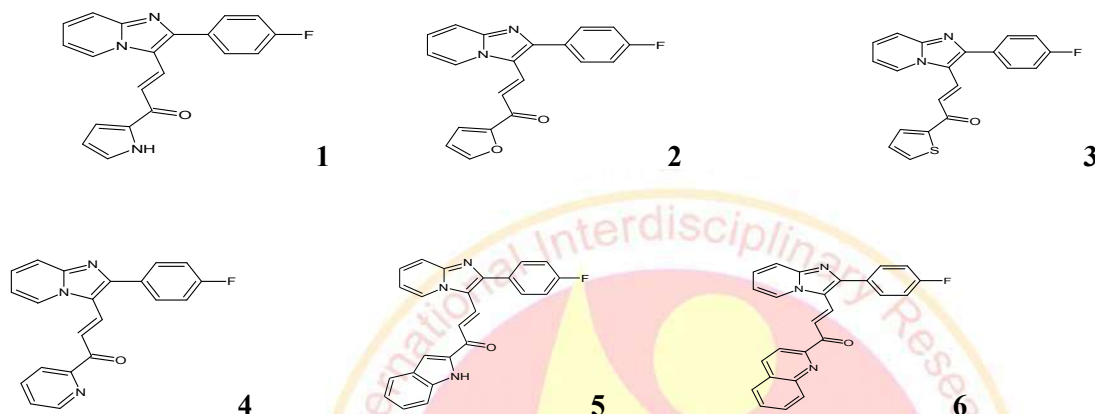
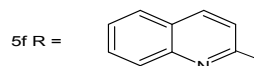
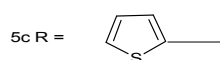
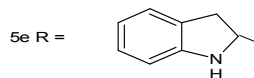
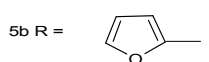
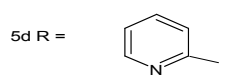
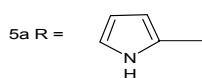
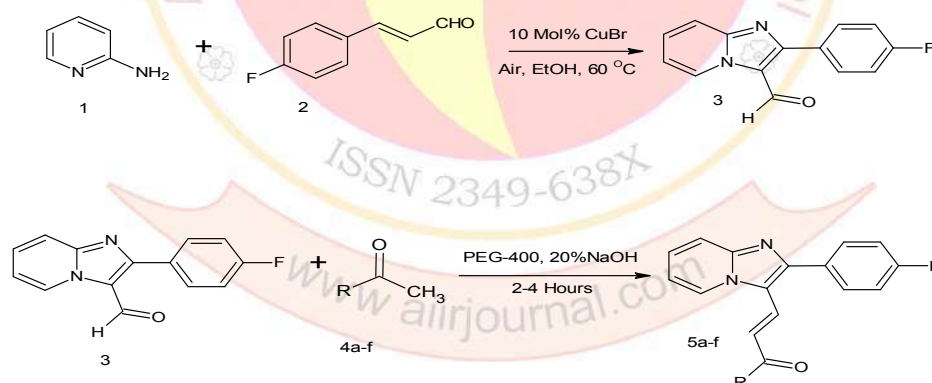

Figure 2- Fluoro Imidazo [1,2-A]-Pyridine Chalcones ( 5a-f)

### Material And Method :

#### Scheme -1 Synthesis of chalcones



### General Instrumentation:

IR spectra were recorded on FT-IR spectrometer (Perkin Elmer, Maharashtra, India) using KBr disk method. <sup>1</sup>HNMR spectra were recorded on <sup>1</sup>HNMR (Varian-NMR-mercury 300 MHz) spectrometer in CDCl<sub>3</sub> as solvent. All chemical shifts (δ) are quoted in parts per million downfield from TMS and coupling constants (J) are given in hertz. Abbreviations used in the splitting pattern were as follows: s = singlet, d = doublet, t = triplet, q = quintet and m = multiplet. All the reagents and solvents were used of analytical grade

and used as supplied unless otherwise stated. Thin layer chromatography was performed on silica gel coated plates for monitoring the reactions. The spots could be visualized easily under UV light.

### General procedure for synthesis of Fluoro imidazo[1,2-a]pyridine carbaldehydes (3).

To the mixture of 2-aminopyridine (1.0 equiv.) and 4- fluoro cinnamaldehyde (1.2 equiv.) in ethanol was added 10 mol% CuBr and the reaction mixture was stirred at 60 °C for 8 h. After completion of the reaction (monitored by TLC), the reaction mixture was filtered using Whatman paper. The filtrate was dried on a rotavapor and was then extracted with water and ethyl acetate. The EtOAc layer was dried over anhydrous sodium sulphate and evaporated on a vacuo rotavapor to get the crude product. The crude product was purified by silica gel (#100–200) column chromatography using n-hexane and EtOAc as eluents to obtain pure products <sup>4</sup> in 70–90% yield.

### 2-Phenyl-imidazo[1,2-a]pyridine-3-carbaldehyde (3) :

**<sup>1</sup>H NMR (CDCl<sub>3</sub>, 400 MHz):** δ 7.51 (d, 1H) aromatic C<sub>3</sub>, δ 7.03 (d, 1H) aromatic C<sub>4</sub>, δ 6.69 (d, 1H) aromatic C<sub>5</sub>, δ 8.09 (d, 1H) aromatic C<sub>6</sub>, δ 7.46 (d, 1H) C<sub>11</sub> & C<sub>15</sub>. aromatic benzene ortho coupling J= 6.9 Hz, δ 7.03 (d, 1H) C<sub>12</sub> & C<sub>14</sub>. aromatic benzene ortho coupling J= 6.9 Hz, δ 9.61 (s, 1H) (d, J = 8.0 Hz, 1H), for CHO

**IR (CHCl<sub>3</sub>):** ν<sub>max</sub> 2930, 1656, 1644, 1494, 1407, 1330, 1250 cm<sup>-1</sup>;

### Synthesis of Imidazo[1,2-a]pyridine Chalcones (5a-f) :

A mixture of various heterocyclic acetyl ketones having moieties like acetyl pyrrole, acetyl furan, acetyl thiophene, acetyl pyridine, acetyl indole and acetyl quinoline respectively and 2-Phenyl-imidazo[1,2-a]pyridine-3-carbaldehyde 3 (1 mmol) was dissolved in 15 ml PEG-400. To this mixture, sodium hydroxide (20%, 1ml) was added and the reaction mixture was stirred at 40-50 °C temperature for 2-4 hours. The reaction mixture was then poured into 100 ml ice cold water. The product was separated out, it was filtered and processed out. The obtained products were recrystallised (5a-f) from ethanol to afford pure compounds.<sup>12-14</sup>

### THE SPECTRAL DATA OF SYNTHESIZED COMPOUNDS 5a-f :

#### 5a-(2E)-3-[2-(4-fluorophenyl)imidazo[1,2-a]pyridin-3-yl]-1-(1H-pyrrol-2-yl)prop-2-en-1-one :

**<sup>1</sup>H NMR (CDCl<sub>3</sub>, 300 MHz):** δ 7.51 (d, 1H) aromatic C<sub>3</sub>, δ 7.03 (d, 1H) aromatic C<sub>4</sub>, δ 6.69 (d, 1H) aromatic C<sub>5</sub>, δ 8.09 (d, 1H) aromatic C<sub>6</sub>, δ 7.46 (d, 1H) C<sub>11</sub> & C<sub>15</sub>. aromatic benzene ortho coupling J= 6.9 Hz, δ 7.03 (d, 1H) C<sub>12</sub> & C<sub>14</sub>. aromatic benzene ortho coupling J= 6.9 Hz, δ 7.54 (d, 1H) C<sub>16</sub> unsaturated C=C-C=O, J= 15.3 Hz, δ 6.67 (d, 1H) C<sub>17</sub> unsaturated C=C-C=O, J= 15.5 Hz. Pyrrole ring – δ 6.98 (d, 1H) C<sub>20</sub>. aromatic, δ 6.21 (d, 1H) C<sub>21</sub>. aromatic, δ 7.23 C<sub>22</sub>. aromatic, δ 5.0 (d, 1H) N-H exchangeable with D<sub>2</sub>O.

#### 5b-(2E)-3-[2-(4-fluorophenyl)imidazo[1,2-a]pyridin-3-yl]-1-(furan-2-yl)prop-2-en-1-one :

**<sup>1</sup>H NMR (CDCl<sub>3</sub>, 300 MHz):** δ 7.51 (d, 1H) aromatic C<sub>3</sub>, δ 7.03 (d, 1H) aromatic C<sub>4</sub>, δ 6.69 (d, 1H) aromatic C<sub>5</sub>, δ 8.09 (d, 1H) aromatic C<sub>6</sub>, δ 7.46 (d, 1H) C<sub>11</sub> & C<sub>15</sub>. aromatic benzene ortho coupling J= 6.9 Hz, δ 7.03 (d, 1H) C<sub>12</sub> & C<sub>14</sub>. aromatic benzene ortho coupling J= 6.9 Hz, δ 7.54 (d, 1H) C<sub>16</sub> unsaturated C=C-C=O, J= 15.3 Hz, δ 6.67 (d, 1H) C<sub>17</sub> unsaturated C=C-C=O, J= 15.5 Hz, furan δ 7.23 (d, 1H), δ 6.61 (d, 1H), δ 7.72 (d, 1H) near to O.

#### c-(2E)-3-[2-(4-fluorophenyl)imidazo[1,2-a]pyridin-3-yl]-1-(thiophen-2-yl)prop-2-en-1-one :

**<sup>1</sup>H NMR (CDCl<sub>3</sub>, 300 MHz):** δ 7.51 (d, 1H) aromatic C<sub>3</sub>, δ 7.03 (d, 1H) aromatic C<sub>4</sub>, δ 6.69 (d, 1H) aromatic C<sub>5</sub>, δ 8.09 (d, 1H) aromatic C<sub>6</sub>, δ 7.46 (d, 1H) C<sub>11</sub> & C<sub>15</sub>. aromatic benzene ortho coupling J= 6.9 Hz, δ 7.03 (d, 1H) C<sub>12</sub> & C<sub>14</sub>. aromatic benzene ortho coupling J= 6.9 Hz, δ 7.54 (d, 1H) C<sub>16</sub> unsaturated C=C-C=O, J= 15.3 Hz, δ 6.67 (d, 1H) C<sub>17</sub> unsaturated C=C-C=O, J= 15.5 Hz, Thiophene - δ 7.61 (d, 1H), δ 7.06 (d, 1H), δ 7.65 (d, 1H) near to S

**5d-(2E)-3-[2-(4-fluorophenyl)imidazo[1,2-a]pyridin-3-yl]-1-(pyridin-2-yl)prop-2-en-1-one :** δ 7.51 (d, 1H) aromatic C<sub>3</sub>, δ 7.03 (d, 1H) aromatic C<sub>4</sub>, δ 6.69 (d, 1H) aromatic C<sub>5</sub>, δ 8.09 (d, 1H) aromatic C<sub>6</sub>, δ 7.46 (d, 1H) C<sub>11</sub> & C<sub>15</sub>. aromatic benzene ortho coupling J= 6.9 Hz, δ 7.03 (d, 1H) C<sub>12</sub> & C<sub>14</sub>. aromatic benzene ortho coupling J= 6.9 Hz, δ 7.54 (d, 1H) C<sub>16</sub> unsaturated C=C-C=O, J= 15.3 Hz, δ 6.67 (d, 1H) C<sub>17</sub> unsaturated C=C-C=O, J= 15.5 Hz,

Pyridine - δ 8.31 (d, 1H), δ 8.17 (d, 1H), δ 7.88 (d, 1H), δ 9.03 (d, 1H).

**5e-(2E)-3-[2-(4-fluorophenyl)imidazo[1,2-a]pyridin-3-yl]-1-(1H-indol-2-yl)prop-2-en-1-one** :  $\delta$  7.51 (d, 1H) aromatic C<sub>3</sub>,  $\delta$  7.03 (d, 1H) aromatic C<sub>4</sub>,  $\delta$  6.69 (d,1H) aromatic C<sub>5</sub>,  $\delta$  8.09 (d, 1H) aromatic C<sub>6</sub>,  $\delta$  7.46 (d, 1H) C<sub>11</sub> & C<sub>15</sub> .aromatic benzene ortho coupling J= 6.9 Hz,  $\delta$  7.03 (d,1H) C<sub>12</sub> & C<sub>14</sub> .aromatic benzene ortho coupling J= 6.9 Hz,  $\delta$  7.54 (d,1H) C<sub>16</sub> unsaturated C=C-C=O, J= 15.3 Hz,  $\delta$  6.67 (d,1H) C<sub>17</sub> unsaturated C=C-C=O, J= 15.5 Hz,

Indole -  $\delta$  7.38 (d,1H ),  $\delta$  7.55 (d,1H ),  $\delta$  7.00 (d,1H ),  $\delta$  7.08 (d,1H ), ),  $\delta$  7.40 (d,1H ),  $\delta$  10.1 (d,1H ) replacable with D<sub>2</sub>O.

**5f-(2E)-3-[2-(4-fluorophenyl)imidazo[1,2-a]pyridin-3-yl]-1-(quinolin-2-yl)prop-2-en-1-one** :  $\delta$  7.51 (d, 1H) aromatic C<sub>3</sub>,  $\delta$  7.03 (d, 1H) aromatic C<sub>4</sub>,  $\delta$  6.69 (d,1H) aromatic C<sub>5</sub>,  $\delta$  8.09 (d, 1H) aromatic C<sub>6</sub>,  $\delta$  7.46 (d, 1H) C<sub>11</sub> & C<sub>15</sub> .aromatic benzene ortho coupling J= 6.9 Hz,  $\delta$  7.03 (d,1H) C<sub>12</sub> & C<sub>14</sub> .aromatic benzene ortho coupling J= 6.9 Hz,  $\delta$  7.54 (d,1H) C<sub>16</sub> unsaturated C=C-C=O, J= 15.3 Hz,  $\delta$  6.67 (d,1H) C<sub>17</sub> unsaturated C=C-C=O, J= 15.5 Hz,

Quinoline -  $\delta$  8.19 (d,1H ),  $\delta$  8.42 (d,1H ), 7.68 (d,1H ),  $\delta$  7.43 (d,1H ), ),  $\delta$  7.61 (d,1H ), ),  $\delta$  8.05 (d,1H ) .

### Biological Evaluation :

All the synthesized Imidazo (1,2-a) Pyridines Chalcone Derivatives have been evaluated for antifungal activity using Cup-plate agar diffusion method. Antifungal activity was compared with *viz* greseofulvin. The zone of inhibition were measured in mm.

### Antifungal Activity :

*Aspergillus niger* was employed for testing antifungal activity<sup>15-17</sup> using cup-plate agar diffusion method. The culture was maintained on sabourauds agar slants sterilized sabourauds agar medium was inoculated with 72 hr. old 0.5ml suspension of fungal spores in a separate flask. About 25 ml of the inoculated medium was evenly spreaded in a Petridish (13cm diameter) and allowed to set for 2 hr. The cups (10 mm in diameters) were punched in petridish and loaded with (0.04g) of solution of sample in DMF. The plates were incubated at 30°C for 48 hr. After the completion of incubation period, the zone of inhibition of growth the form of diameter in mm was measured. Along the test solution in each petridish one cup was filled up with solvent, which acts as control. The zone of inhibition of test solution are recorded in table-1.

**Table 1 : Biological Screening For Antifungal Activity Of Synthesized Imidazo (1,2-A) Chalcon Derivatives**

Entry	<i>In vitro</i> activity- zone of inhibition in mm <i>Aspergillus niger</i>
5a	15
5b	14
5c	20
5d	19
5e	17
5f	18
Greseofulvin	27

### Result And Discussion:

In the present study, the synthesis of title compounds of Fluoro Imidazo[1,2-a] pyridine Chalcones (5a-f) by Claisen Schmidt condensation has been carried out successfully by using selected heterocyclic ketones like acetyl pyrrole, acetyl furan, acetyl thiophene, acetyl pyridine, acetyl indole and acetyl quinoline and 2-Phenyl-imidazo[1,2-a]pyridine-3-carbaldehyde 3 (1 mmol) was dissolved in 15 ml PEG-400 according to literature methods (Scheme 1). The purity of the newly synthesized compounds was recognized by TLC. The characterization of all the listed synthesized Chalcones were made by IR , NMR spectral analysis. The formation of chalcones (5a-f) was confirmed by IR and NMR spectra. Chalcones showed the IR absorptions characteristics of carbonyl >C=O (1685-1600 cm<sup>-1</sup>) and aromatic C=C (1580-1400 cm<sup>-1</sup>) functionalities. The band at 750 cm<sup>-1</sup> shows halide C-F stretch. The IR of 2-Phenyl-imidazo[1,2-a]pyridine-3-carbaldehyde (3) shows the various band at  $\nu_{max}$  2950, 1656, 1644, 1494, 1407, 1330, 1250 cm<sup>-1</sup>; due to C-N, C=N, CHO,



aromatic benzene ring etc. The  $^1\text{H}$  NMR spectra of chalcones displayed multiplet due to aromatic protons at 6.92- 8.00  $\delta$  (m, Ar-H) and unsaturation at 7.54- 6.67  $\delta$  due to unsaturated  $\text{C}=\text{C}-\text{C}=\text{O}$ , having a coupling constant  $J = 15.5$  Hz. Particulars of the methods and conditions are described in the experimental section. Investigation of antifungal screening data revealed that the compounds 5c, 5d, 5e and 5f for their antifungal screening shows maximum zone of inhibition against fungi *Aspergillus niger* but less than the standard used for screening *A. niger*. Further bioassay, optimization and structure-activity relationship of the title compounds are in progress.

### Conclusions:

In conclusion, we have successfully developed a copper(II) catalyzed aerobic oxidative coupling of 2-aminopyridines with 4-fluorocinnamaldehydes for one-pot synthesis of 3-formyl-2-phenyl fluoroimidazo[1,2-a]pyridines. We have synthesized a new class of chalcones, wherein the B-ring has been replaced by a fluoroimidazo[1,2-a]pyridine moiety. The developed method is operationally simple and could be used efficiently for the preparation of biologically important Imidazo[1,2-a]pyridines Chalcones. Almost all of the newly synthesized compounds showed potent antifungal activities against fungi *A. niger*. However, a further study of antioxidant and anti-inflammatory evaluation of fluoroimidazo[1,2-a]pyridine Chalcones is in progress, concerning the structural arrangements of the heterocyclic ring as it is responsible to show various biological activities. Fluoroimidazo[1,2-a]pyridine Chalcones Compound 5c, 5d, 5e and 5f for their antifungal screening shows maximum zone of inhibition against fungi *A. niger* but less than the standard used for screening.

### Acknowledgement :

Author is very much thankful to the Director, School of Chemical Sciences, Solapur University, Solapur for providing research facilities and thankful to Prof. K.D. Sonawane, Head, Department of Microbiology, Shivaji University, Kolhapur for the determination of biological evaluation of the synthesized chalcones. Also thankful to the Principal, Smt. Kusumtai Rajarambapu Patil Kanya Mahavidyalaya, Islampur for their kind support and immense help throughout the experiment.

### Conflict of Interest

The authors confirm that this article content has no conflict of interest.

### References:

1. Hanson S.M., Morlock E.V., Satyshur K.A., Czajkowski C. (2008) Structural requirements for eszopiclone and zolpidem binding to the gamma-aminobutyric acid type-A (GABAA) receptor are different. *J Med Chem.*, 51(22): 7243-52.
2. Joshi, M. J., Vekariya, P. B., Dodiya L, Ghetiya, R.M. and Joshi, H.S.(2012). Synthesis and biological study of some new chalcones and oxopyrimidines containing imidazo[1,2-a]pyridine nucleus. *J. Heterocyclic Chem.*, 49, 130 (2012).
3. Bharate, J. Abbat S. Prasad V. Bharatam, R., Vishwakarma, A. and Bharate, S.(2015).
4. CuBr catalyzed aerobic oxidative coupling of 2-aminopyridines with cinnamaldehydes:
5. Direct access to 3-formyl-2-phenyl-imidazo[1,2-a]-pyridines. *Org. Biomol. Chem.*, 13, 7790. 5. Gopal, S. M., and Anitha I.(2016). Green synthesis of imidazo[1,2-a]pyridines in aqueous medium. *Journal of Applied Chemistry*, 9(4), 01-05.
6. Kumar S. and Sahu, D.P.(2008). Aqueous phase synthesis of bridgehead azaheterocycles in the presence of  $\beta$ -cyclodextrin, *ARKIVOC*, (xv), 88-98.
7. Gopal, M. S., Anitha, I. (2014). Aqueous phase microwave synthesis of some bisindolizines, *International Journal of Chemical Studies*, 2(4), 35-38.
8. Kamal, A., Reddy, J.S., Ramaiah, M.J., Dastagiri, D., Bharathi, E.V., Sagar, M.V.P., Pushpavalli, C.V.L.S.N., Ray, P., Bhadra, M.P., (2010). Design, synthesis and biological evaluation of imidazopyridine/pyrimidine-chalcone derivatives as potential anticancer agents, *Medicinal Chemical Communications*, 1(5), 355-360.
9. Ide, S., Katou, K., Itou, T., Motokawa, C., Chiyomaru, Y., Matsuda, Y., (1993). Synthesis of imidazo[1,2-a]pyridine derivatives and their reactions. *Yakugaku Zasshi*, 113(12), 861-869.

10. Wang, J., Mason, R., VanDerveer, D., Feng, K., Bu, X.R., (2003). Convenient preparation of a novel class of imidazo[1,5-a]pyridines: decisive role by ammonium acetate in chemoselectivity, *Journal of Organic Chemistry*, 68(13), 5415–5418.
11. Adib, M., Sheibani, E., Zhu, L.G., Mirzaei, P., (2008). An efficient synthesis of 3-amino-2-arylimidazo [1,2-a] pyridines, *Tetrahedron Letters*, 49(34), 5108–5110.
12. Jadhav, S., Bhosale, R., Shirame, S., Patil, S., Kulkarni, S., (2015). PEG Mediated Synthesis and Biological Evaluation of Asymmetrical Pyrazole Curcumin Analogues as Potential Analgesic Anti-Inflammatory and Antioxidant Agents. *Chem. Biol Drug Des.*, 85: 377-384.
13. Jadhav, S., Shirame, S., Kulkarni, S., Patil, S., Pasale, S., Bhosale, R., (2013). PEG mediated synthesis and pharmacological evaluation of some fluoro substituted pyrazoline derivatives as anti-inflammatory and analgesic agent. *Bioorganic Medicinal Chemistry Letter*, 23:2575–2578.
14. Jadhav, S., Bhosale, R., Shirame S., Sonawane V., Hublikar, M., Sonawane. K., Shaikh, R., (2013). Synthesis And Biological Evaluation Of Fluoro-Hydroxy Substituted Pyrazole Chalcones As Anti-Inflammatory, Antioxidant And Antibacterial Agents. *International Journal of Pharm Biosciences*, 4: 390–397.
15. Rupala, R. G., Dinesh, S., Patel K., (2014). Synthesis, Characterization and Biological Evaluation of Some Novel Chalcone Derivatives Containing Imidazo[1,2-a]Pyridine Moiety *Journal of Chemistry, Environmental Sciences and its Applications*, 1(1), 23–32.
16. Bhale, P., Dongare, S., Umakant B., Chanshetti U. B., (2013). Synthesis and Antimicrobial screening of Chalcones containing imidazo [1,2-a] pyridine nucleus *Research Journal of Chemical Science*, 3(12), 38-42.
17. Saddik, R., Gaadaoui, A., Koudad, M., Ousaid, A., Elaatioui, A., Hamal, A., Zarrouk, A., and Benchat, N., (2014) Synthesis, antimicrobial and antifungal screening of novel chalcones containing imidazo[1,2-a] pyridine nucleus. *Der Pharma Chemica*, 6(4): 147-152.



## ‘ Sustainable Development, Enhance In Environment And Green Economy With Gender Equality’

**Vilas S. Patil**Assistant Professor  
Y.C.W.M.Warananagar  
Tal-Panhala, Dist- Kolhapur**Manisha V. Patil.**Librarian  
Shripatrao Chougule Arts & Commerce College  
Malwadi- Kotoli, Tal-Panhala, Dist- Kolhapur**Abstract:**

*‘Sustainable development is only attainable when the needs and interests of both men and women are fully recognized’. Gender inequality primarily affects women: they experience poverty differently from men because they are denied equal rights and opportunities, lack access to resources and services and are excluded from important decisions that affect their lives and development.’*

*Gender equality is, first and foremost, a human right. Women are entitled to live in dignity and in freedom from want and from fear. Empowering women is also an indispensable tool for advancing development and reducing poverty. Empowered women contribute to the health and productivity of whole families, communities and to improved prospects for the next generation. The importance of gender equality is underscored by its inclusion as one of the eight Millennium Development Goals. Gender equality is acknowledged as being a key to achieving the other seven goals. Information and communication technologies in recent years have been recognized as an effective tool for promoting economic growth and sustainable development. Women need encouragement and support from the family members, government, society, male counterparts etc., with the right assistance from varied groups; they can join the main stream of national economy and thereby contribute to the economic development.*

*Sustainable development with gender equality means for policymaking purposes: economic, social and environmental development that ensures human well-being and dignity, ecological integrity, gender equality and social justice, now and in the future.*

*This paper focuses light on how the environment is linked to the development challenge or how we are responsible for it. The aim of this paper is to provide preliminary information on why consideration of the environment is critical to gender equality, and vice versa, and to indicate where to go to find additional information. As environmental sustainability and gender equality are both cross-cutting issues and development objective. Also this paper focus light on how the sustainable development and green economy are depend on gender equality and how they relate with each other.*

**Keywords:** Sustainable Development, Green Economy, Gender Equality, Empowering women, Environment and Gender Equality.

**1.0 Introduction:**

Gender inequality negatively affects women more than men, and due to their resulting unequal status in society, women are disproportionately affected by poverty. There are huge inequalities between men and women’s control of, access to and benefit from natural resources. These disparities between men and women adversely affect the quality of life for society as a whole, hinder development and impede poverty reduction. A full understanding of the gender dimensions of poverty and of the inequalities which determine women’s disadvantaged position in society is necessary if the rights and needs of women and men are to be met equally and sustainable development is to be achieved. Approaches, which address these inequalities by empowering women and achieving gender equality, should be central to strategies to reduce poverty.

The centrality of gender equality, women’s empowerment and the realization of women’s rights in achieving sustainable development has been increasingly recognized in recent decades. Which included recognition of the importance of gender equality and women’s empowerment across the three pillars of sustainable development, economic, social and environmental, and resolve to promote gender equality and women’s full participation in sustainable development policies, programmes and decision-making at all levels. There is growing evidence of the synergies between gender equality, on the one hand, and economic, social and environmental sustainability, on the other. For example, when women have greater voice and participation in public administration, public resources are more likely to be allocated towards investments in human development priorities, including child health, nutrition and access to employment.

Ensuring women’s access to and control over agricultural assets and productive resources is important for achieving food security and sustainable livelihoods. Women’s knowledge, agency and collective action are central to finding, demonstrating and building more economically, socially and environmentally sustainable pathways to manage local landscapes; adapt to climate change; produce and access food; and secure sustainable water, sanitation and energy services. While gender equality can have a catalytic effect on achieving economic, social and environmental sustainability, the reverse does not always hold true. Hence, a simple “win-win” relationship between gender equality and sustainability cannot be assumed. Further, as governments and donor agencies increasingly target women as critical agents for community adaptation to climate change; in their role as smallholders as the mainstay of sustainable food production; and through limiting their reproductive rights as the answer to population-environment problems; there is a danger of

entrenching gender stereotypes and inequalities. Policy responses that view women as “sustainability saviours” draw upon and reinforce stereotypes regarding women’s roles in relation to the family, the community and the environment. Such responses often add to women’s already heavy unpaid work burdens without conferring rights, resources and benefits. Power imbalances in gender relations determine whether women’s actions and work translate into the realization of their rights and capabilities. While the participation of women is vital, their involvement in policy interventions aimed at sustainability does not automatically mean greater gender equality, particularly when the structural foundations of gender inequality remain unchanged. The green economy, gender equality and care, elaborates on the interactions between growth trajectories and rising inequalities, underscoring the exploitation of women’s labour through low wages and reliance on extensive and unpaid care work.

## 2.0 Environment issues because of Gender Equality

- Women perform two thirds of the world’s working hours, produce half of the world’s food, earn only 10% of the world’s income and own less than 1% of the world’s property.
- Women are more reliant on natural resources for their livelihoods than men as they do not have equitable access to alternatives such as wage labour and the security and benefits these provide.
- Degraded environments mean that women have to walk further to collect water and fuel wood. As a result their access to education and other productive activities may be curtailed and they will be exposed to the risk of gender based violence in isolated areas
- Women have less control of and access to land and natural resources than men – in many cases women are excluded from formal ownership of land.
- Due to their socially constructed roles and existing inequalities, women are more vulnerable to the impacts of environmental and natural disasters such as drought, floods and cyclones than men.
- Women are disproportionately vulnerable to sexual exploitation and abuse and other forms of violence in times of vulnerability and need. This risk increases at times of disaster.

## 3.0 Conceptual Framework for Gender Equality

Since promoting of gender equality is a critical understanding and complex entity to measure, the conceptual model of Laizu et al. (2010) is considering appropriate. The framework has been developed for South East Asian countries to empowering women towards promoting gender equality through the interventions of ICT. Figure 1 presents the independent variables of women behavior such as personal characteristics (Education level, Age) together with motivation level (Information Type, Purpose of Involvement and Access Level) which has a variation between each person. These independent variables are affecting dependent variables (Material, Cognitive, Perceptual, Relational and Technological change). For example, an educated woman can learn ICT skills and acquire knowledge more easily than the woman who has no education and therefore can Perceive changes. Similarly, the rest of the variables - age, purpose of involvement in ICT project, ICT access and information type affects women’s skill and knowledge though ICT intervention to women empowerment towards promote gender equality.

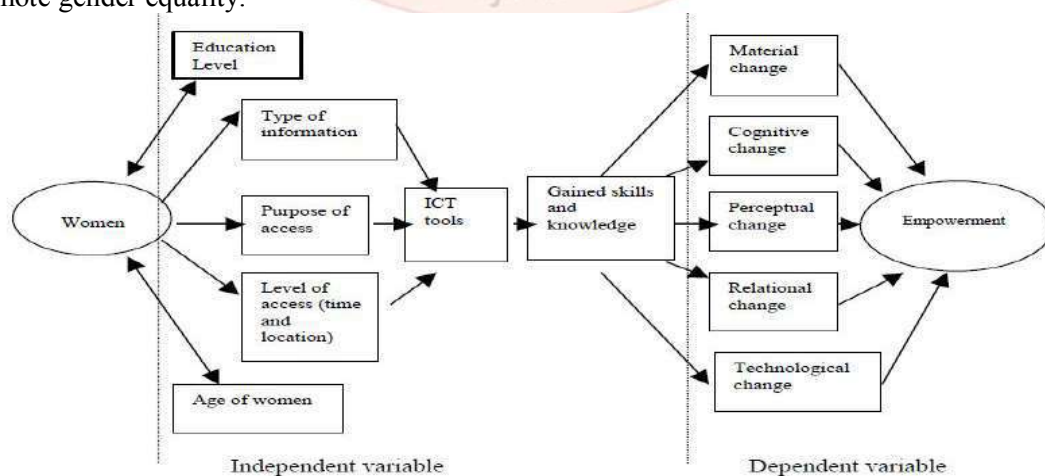

Figure 1: Conceptual Model to promote gender equality (Laizu et al. 2010).

The 4 dependent variables of the conceptual model adopted from Chan (1997) consolidate framework which defines Material, Cognitive, Perceptual and Relational change through the intervention of ICT. The technological change has defined by Lennie’s (2002) rural woman empowerment model.

**Material Change:** Through the material pathway a changes has come towards the access or control over material resources. For example, in the earning capacity, in the level of income, in the satisfaction of basic needs.

**Cognitive Change:** Though the cognitive pathway the changes has come into the level of knowledge, skills or awareness of wider environment. **Perceptual Change:** Individual confidence level, future vision as well as changes in recognition and respect by others are experienced through perceptual pathway.

**Relational Change:** Through the relational pathway changes has come in the dependency on other, bargaining power, decision making role, participation in non-family groups.

**Technological Change:** Technological change has come through the access of information, knowledge, skills and resources and their potential benefits and impacts.

#### 4.0. Women, Environment and Development:

Poor men and women are increasingly recognized as caretakers of the environment . Women are particularly reliant on the environment to meet their basic needs and play an essential role as managers (i.e. use and control) of natural resources. Women are responsible for reproduction and production in the household and for water and energy needs, placing them in direct contact with the natural environment on a daily basis. Women therefore rely more heavily on natural resources than men as they have fewer alternative sources of livelihood. Men can migrate to urban centre's to look for work and diversify into labouring or small business, while women often must remain at home to fulfil responsibilities such as caring for the family, sick and elderly. They rely on the resources available to them locally to fulfil these needs. They tend to grow crops and keep small animals for consumption and rarely engage in cash cropping or market orientated production as they are too occupied meeting day to day needs. Although women are highly reliant on their local environment for their livelihoods, they frequently lack ownership and decision-making power over the natural resources on which they depend. These factors limit women's potential to climb out of poverty, makes them very vulnerable to environmental change or degradation, and increases and perpetuates inequality.

#### 5.0. Environmental change and gender equality:

Population growth, changing climatic conditions and increasing pressure on resources leads to environmental degradation. The result is scarcity of resources and declining resource quality with knock-on effects on livelihoods. Water and fuel wood are vital natural resources and their collection and use in the household is largely the responsibility of women and girls. As water supplies and other natural resources become depleted due to over-exploitation, the amount of time and energy women and girls spend on household duties dramatically increases. Women have to travel further to collect water and fuel, requiring much of their valuable time. Girls may be taken out of school to assist with these tasks and because they cannot complete their education their future prospects are limited. Venturing into isolated areas in search of resources may also expose them to the added risk of gender based violence and it's resulting consequences. According to the World Health Organisation, the daily energy requirement to carry water may consume one third of a woman's calorie intake. Environmental degradation entrenches the disadvantaged position of women and girls in relation to men as they have less time and less energy for other productive activities, and gender stereotypical roles and inequality are perpetuated. Exposure to industrial and agricultural chemicals and organic pollutants through daily farming has a profound impact on women's health; it affects their reproductive health, leading to complications in childbirth and pregnancy. This further incapacitates them, increasing their difficulties in securing their livelihood and in participating in development processes. Urbanisation as a result of environmental degradation also has disproportionately negative effects on women. Due to their caring and domestic roles, they are exposed more readily to chemicals and pollutants found in water sources in cities. Overcrowding in slums results in the added risk of air and smoke pollution from fires within small dwellings. Minimal security of these dwellings means their safety and health is compromised, placing them at risk of Gender Based Violence.

#### 6. Access to decision-making and representation:

A related knock-on effect of environmental degradation is that women have less time for participation in community affairs and are often not consulted on key environmental programmes and plans. Women should be equally involved in designing and managing water and sanitation facilities and other communal natural resources. For example, as the main users of wells and water pumps, women should have real input into the location of water points and in their management. Both women and men can be trained in the maintenance of pumps and given equal responsibility for collecting and managing water use fees. While household hygiene tends to be the responsibility of women, training men as well as women in this role ensures that both women and men understand and take responsibility for the links between sanitation and safe drinking water and the

protection of their own and their families' health. Care should always be taken to ensure that gender stereotypical roles are not reinforced, that women's work burden is not increased and that the benefits of and responsibility for water management is enjoyed equally by men and women.

In poor communities wood or dung is collected as fuel by women and burned for cooking, warming water and as a source of heat. Women are frequently blamed for deforestation due to their fuel wood collecting activities while more often than not it is the cutting of wood for construction materials and for sale (primarily male activities) that is the primary cause. Women tend to collect dead wood which burns more easily; they only cut green wood if they have no alternative. By drawing women and men into environmental management and understanding their different needs and perspectives, policies can be developed that meet the needs of entire communities without compromising the sustainability of the resource base. Women particularly need specific and official channels of support to ensure that they can access and participate in decision-making related to the environment and must be involved in management on a burden-sharing basis with men.

## 7. Green economy:

The environmental and social costs associated with dominant patterns of growth have motivated the search for alternative models of development that are sustainable. A case in point is the green economy agenda, where the greening of investment and public policy in both developing and developed countries is intended to enhance environmental protection while also creating jobs and stimulating economic growth. There are, however, different variants of green economy. Dominant variants of green economy assume continued, even enhanced, market-led economic growth, through green business investments and innovations that increase energy and resource efficiency and prevent the loss of ecosystem services. Other strands emphasize market-based approaches to environmental protection through financial valuation of natural capital (e.g., Natural Capital Committee, 2013), payments for ecosystem services and schemes for trading carbon and biodiversity credits and offsets. For the proponents of such approaches, markets fail to price natural assets and ecosystem services,

Which are ultimately factors of production much like capital and labour. The result is that this natural capital is overexploited relative to what is socially or economically optimal. In this context, where negative externalities render market outcomes socially inefficient, market interventions, such as taxing carbon or legislating so that forest management rights are given to local communities, are aimed at properly pricing natural assets and defining property rights. In doing so, they bring market-determined growth processes more closely in line with environmental values (World Bank, 2012).

These market-based approaches can be problematic from a social perspective, leading to greater inequality and injustice for local users vis-à-vis external and global actors. As a recent report by the United Nations Research Institute for Social Development (UNRISD) puts it, payments for ecological services, the process relating to the United Nations Collaborative Programme on Reducing Emissions from Deforestation and Forest Degradation in Developing Countries (REDD) and incentives to produce biofuels often involve trade-offs with smallholder agriculture, biodiversity, livelihoods and food security. Moreover, market-based approaches often promote corporate interests, which in turn may constrain the scope for policy and regulatory reform that is conducive to social and sustainable development (UNRISD, 2012b). As such, there is not enough integration of the social dimensions of sustainable development in these market-based approaches to green economy.

A green economy, according to UNEP, is one that ends extreme poverty, improves human wellbeing and enhances social equity while reducing carbon dependency and ecosystem degradation and furthering sustainable and inclusive growth (UNEP, 2009; 2011). This definition corresponds to the general understanding of sustainable development and its three dimensions, economic, social and environmental. Green Keynesianism, also presented as green stimulus or a "global green new deal" (GGND), argues for directing government spending towards technology and employment generation in ways that enhance environmental protection and raise efficiency, for instance by retrofitting energy-inefficient buildings or infrastructure (e.g., UNEP, 2009). These sorts of green investments were a much discussed and promoted part of countercyclical macroeconomic policies adopted in the wake of the global recession of 2008, in both developed and developing countries. The proposal by UNEP emphasized the principle of common but differentiated responsibilities with regard to developed countries, emerging economies, countries with economies in transition and the least developed countries. A "fair and just GGND, therefore, should consider including developed countries' additional support to other countries, especially least developed countries, in the areas of finance, trade, technology and capacity building in the interest of effectiveness as well as fairness" (UNEP, 2009). Gender equality is a marginal concern in most of these proposals. An alternative to the green economy approaches discussed above is the work of those linked with the environmental justice movements, who see environmental preservation as an opportunity to understand and redress multiple forms of inequality. For example, maintaining crop biodiversity

enables future food producers to deal with new pests and diseases that threaten the food supply. Today, crop biodiversity is sustained largely by farmers in the global.

## 8. Women and green jobs

A part of the green growth agenda targets the expansion of green jobs, which are understood primarily in terms of their environmental impact, but also seek to comply with ILO notions of decent work. In terms of industry, where it is estimated that 80 per cent of green jobs will be located, a small number of manufacturing industries are responsible for a large share of resource and energy use as well as greenhouse gas emissions and other pollutants (International Labour Foundation for Sustainable Development, 2009). These include energy, construction, transportation and, among basic industries, aluminium, iron and steel (ILO, 2012). Most of the projected employment gains are expected to come from activities involved in transitioning to a low-carbon economy, including developing renewable energy resources, producing more fuel-efficient vehicles, constructing and retrofitting buildings, transport and infrastructure, and waste management and recycling. In manufacturing, the emphasis is on introducing clean processing techniques and controlling pollution, with less of an apparent total employment effect. Green jobs are generally middle-skill jobs, and expanding sectors are seen as more skill- and knowledge-intensive than their counterparts in conventional industry; the concomitant pay and benefits are also higher. These features make the association between green jobs and decent work a seemingly natural one, but the connection is closer in some sectors than others. Investments in agriculture, for example, which continues to be the single largest sector in terms of employment, and which is the main sector of employment in rural areas, where the majority of the world's poor and extremely poor live and work, is potentially very promising. The shift to green jobs is also sometimes seen as an opportunity to draw women into non-traditional, more highly paid sectors such as engineering, construction and manufacturing because they are perceived as less limited by entrenched gender stereotypes. Though the goals of greening jobs are laudable, benefits for women may not be automatic and the potential impacts on women's employment requires explicit consideration. Given the extent of gender segregation in labour markets generally, and within industry in particular, where women constitute only 30 per cent of the global workforce, there is a risk that efforts to green industry will not only bypass women, but actually marginalize them. Sectors targeted for green employment expansion, such as energy, construction and basic industry, are very male dominated and recent trends indicate that sectoral segregation is increasing rather than decreasing. Among green jobs that already exist, women tend to have low representation and/or occupy the lower value-added rungs. For instance, in OECD countries, where women earn more than half of university degrees, only 30 per cent of degrees in science and technology (key areas of study for green jobs) go to women. In developing economies, women are highly concentrated on the low value-added end of extant green jobs, for instance as informal workers in waste collection and recycling.

## 9. Control over and access to resources:

Access to resources is a critical factor affecting poverty reduction and income generation. Poor men and women tend to have very insecure access to natural resources despite their reliance on them for their livelihoods. Redistribution of land by government, resettlement and the sale of traditionally held lands to commercial enterprises can leave poor men and women landless or reliant on more marginal lands. Tenure security encourages farmers to invest in their land through soil conservation, fertilization and irrigation and it can help them to access credit using the land as collateral. However, women traditionally do not have access to technical inputs and advise that increase productivity and some actors may erroneously not consider them to be 'farmers' or to be economically active. The World Bank estimates that if women had equal access to agricultural inputs, the total agricultural output for the region could increase by up to 20 percent. The issues of access to and control over resources affects men and women differently. In most societies, land is traditionally the property of men and is handed down from father to son.

In many cases women cannot own or inherit land, even if they are responsible for tilling the land and growing crops. This can mean that women do not have rights to the income derived from the crops they have grown and it poses serious problems if a woman's husband dies and his family inherits the land, leaving her and her children destitute. Women may also not have a say in how the land is used and what use is made of crops despite their role in producing these crops.

As land and resource use laws change, women need to be informed of their new rights. Agencies need to remember that women may be unable to attend public meetings on these issues for social reasons or be unable to travel due to family responsibilities. This lack of exposure to information and the high levels of illiteracy among women mean that they tend to be less well informed about their rights than men. There is also a tendency among aid agencies to assume that men will pass on the information to their wives, which may not

always be the case. Initiatives to educate women and men about their rights must be tailored around the daily roles and responsibilities of men and women, and where necessary, tailored to facilitate women's participation.

Poor men and women are highly dependant on Common Property Resources (CPRs) such as forests, pastureland, fishing grounds and wetlands for their livelihoods. These commonly owned resources provide poor men and women with wild foods , medicinal plants and construction materials. CPRs are managed by traditional, socially accepted rules, which may or may not ensure equity of access and sustainable use (matriarchal versus patriarchal systems). When these rules break down due to pressures from population growth and development, resources can become scarce and degraded. Women are specially dependent on CPRs as they often don't have access to formally recognized farming lands. As CPRs become degraded or are converted to other uses (e.g. wetlands reclaimed for intensive farming, forests cleared for roads) women lose a valuable source of food and income.

#### **10. Vulnerability and environmental security:**

Poor households are vulnerable to environmental shocks, including drought, floods, cyclones and outbreaks of disease. Women headed households tend to be the most vulnerable in a community, and are at a greater disadvantage when disaster strikes. Women tend to have less diversified opportunities for income generation than men and are wholly reliant on the natural resource base pre and post disaster. In situations of mass population movement, such as displaced and refugee settings, women are often wrongly blamed for destruction of their new surroundings as they continue to collect wood and other resources for their family's survival. Aid organizations must be encouraged to address the gendered responsibilities of members of these populations by assisting men and women to find environmentally sound ways to meet their requirements. Women are also more likely to have fewer assets than men, especially physical assets that can be sold in times of stress. Limited access to credit and market-based activities mean that women have limited opportunities to reduce their vulnerability to natural shocks such as drought, land degradation and flooding.

Environmental disasters are not gender neutral . Women and children are particularly affected by disasters, accounting for more than seventy five percent of displaced persons. In addition to the general effects of natural disasters and lack of health care, women are vulnerable to reproductive and sexual health problems, and increased rates of sexual and domestic violence which require specific response interventions. Women's vulnerability increases when they lose their husbands and are forced to provide for their families on their own and struggle for recognition in patriarchal systems.

#### **11. Positive actions to maximise links between environment and gender:**

There are many opportunities in the Irish Aid programme to address the linkages between environment and gender equality. Both issues are addressed through mainstreaming training and are further elaborated in the Irish Aid mainstreaming strategy.

To be effective, strategies to decrease poverty and preserve the environment need to take into account the disparities between men and women's access to resources and livelihood opportunities.

Opportunities to mainstream environment and gender equality and to enhance synergies between them include the following:

- > Raise awareness of the impact of environmental degradation and environmental risk on women's livelihoods, health and safety.
- > Ensure women and men are equally involved in decision making for environmental policy and planning.
- > Identify opportunities to mainstream environment and gender equality in Poverty Reduction Papers (PRSPs) and Country Strategy Papers (CSPs), sector strategies and area based programmes.
- > Identify win-win activities for environment and gender equality e.g. natural resources managed equally by men and women in communities; livelihood diversification to meet men's and women's needs; support strategies to empower women to engage equally with men in decision making related to the environment and natural resources.
- > Promote and support women's rights to access, use and ownership of land and other natural resources.
- > Improve women's access to credit so that they can diversify their income generating activities and reduce their dependency on natural resources.
- > Support research into understanding the coping strategies of poor women and men and identifying ways to protect the natural resources on which they depend in times of stress.
- > Ensure gender sensitive approaches are used in responding to natural disasters and in post-conflict and recovery situations.
- > Ensure that agricultural extension services take account of gender roles and responsibilities in target communities and tailor appropriate training and inputs at both women and men.



> Identify opportunities to provide specific support to address inequalities in the way that natural resources are used, owned and managed by men and women.

## 12. Broadening The Green Economy Agenda:

The dominant development models present formidable challenges for social, environmental and even economic sustainability, as the multiple crises of recent years have made clear. Current economic models have been limited in reducing gender inequalities and enabling the realization of human rights. Policymakers need to steer their economies and societies along new pathways, within which sustainability and gender equality can reinforce each other. In order to do so, policies should be aimed at the creation of green jobs that offer decent pay and working conditions and provide social protection and prospects for advancement, within an enabling macroeconomic framework policy. Current efforts to promote green jobs often overlook the potential, in the context of creating a green economy, of providing decent work and sustainable livelihoods for women. If green jobs schemes are to expand their scope and impact, they need to become more inclusive of women and more gender-responsive. This means ensuring that green growth policies increase access for women, particularly poor and marginalized women, into high quality jobs in sustainable and low-carbon industries. The potential of integrating the green and care economies remains largely untapped, but if properly resourced and supported, would constitute an important strategy for achieving economic, social and environmental sustainability.

In order for this strategy to advance gender equality and human rights, the expansion of women's capabilities and the recognition, reduction and redistribution of care would have to become key criteria for policy success. Moving away from current patterns of consumption and production requires an emphasis on social investment, production and consumption through hybrid systems involving for-profit as well as a variety of non-profit institutions that can be responsive to people's needs and demands, irrespective of their income or wealth. A key priority would be investments in a variety of public goods, including health, education, food, water and sanitation and sustainable energy, as well as robust and gender-responsive care systems to ensure social sustainability investment in infrastructure and services that reflect their nature as public goods. Barring such intervention, market operations will result in shortages of ecological and care services, shortages that ultimately press into the realm of crisis. If green jobs schemes are to expand their scope and impact, they need to become more inclusive of women and more gender-responsive.

## Conclusions:

Develop and implement policies on the economic, social and environmental dimensions of sustainable development in line with international norms and standards on gender equality, non-discrimination and human rights. Promote transitions to sustainable low carbon, climate-resilient consumption and production patterns while ensuring gender equality. Ensure women's right to an adequate standard of living, through increasing access to decent work and providing gender-responsive, universally accessible and high quality services, social protection measures and infrastructure, including education, health, water and sanitation, and energy. Promote a renewed social contract between states and people that ensures the financing and implementation of sustainable development, with universal access to public goods and services and common pool resources, particularly for the poorest groups of women and girls. Recognize, reduce and redistribute unpaid care work between women and men within households, and between households and the state by expanding basic services and infrastructure that are accessible to all. Respect, protect and promote sexual and reproductive health and rights for all, particularly women and girls, across the lifecycle. Protect the commons and prevent the appropriation and exploitation of natural resources by private and public interests, through state oversight and multi-stakeholder regulation. Ensure the full and equal participation of women and girls in sustainable development policies and initiatives as actors, leaders and decision makers.

Ensure that macroeconomic policies are geared towards creating decent work and sustainable livelihoods and reducing inequalities based on gender, age, income, geographical location and other context-specific characteristics. Prioritize the development of gender responsive policies aimed at generating decent work, with a focus on labour market segregation, gender wage gaps and the unequal distribution of unpaid care work within households, and between households and the state. Ensure that green growth strategies are gender-responsive and socially, economically and environmentally sustainable. Ensure that green growth policies increase access for women, particularly for poor and marginalized women, to high quality jobs in sustainable and low-carbon industries. Invest in women's skills development and education to increase their access to green jobs, including targeted measures to increased women's education, employment and leadership in science, technology, engineering and mathematics. Promote and protect the rights of

domestic workers by ratifying the Domestic Workers Convention, 2011 (No. 189) of the International Labour Organization and by developing .

### Reference:

1. Adams, V., M. Murphy and A. E. Clarke (2009). Anticipation: technoscience, life, affect, temporality. *Subjectivity*, vol. 28, No. 1, pp. 246-265.
2. Adams, W. M. (2004). *Against Extinction: The Story of Conservation*. London: Earthscan.
3. Agarwal, B. (1992). The gender and environment debate: lessons from India. *Feminist Studies*, vol. 18, No. 1, pp. 119-158.
4. Arza, C. (2014). The gender dimensions of pension systems. Background paper prepared for the United Nations Entity for Gender Equality and the Empowerment of Women. New York.
5. Bailis, R., and others (2009). Arresting the killer in the kitchen: the promises and pitfalls of commercializing improved cookstoves. *World Development*, vol. 37, No. 10, pp. 1694-1705.
6. Bain, C. (2010). Structuring the flexible and feminized labor market: GlobalGAP standards for agricultural labor in Chile. *Signs: Journal of Women in Culture and Society*, vol. 35, No. 2, pp. 343-370.
7. Black, M., and G. Fawcett (2008). *The Last Taboo: Opening the Door on the Global Sanitation Crisis*. London: Earthscan.
8. Blecker, R. (2012). Global imbalances and the U.S. trade deficit. In *After the Great Recession: The Struggle for Economic Recovery and Growth*, B. Cynamon, S. Fazzari and M. Setterfield, eds. New York: Cambridge University Press.
9. Budig, M., and J. Misra (2010). How care-work employment shapes earnings in cross-national perspective. *International Labour Review*, vol. 149, No. 4, pp. 441-460.
10. Budlender, D. (2010). What do time use studies tell us about unpaid care work? Evidence from seven countries. In *Time Use Studies and Unpaid Care Work*, D. Budlender, ed. New York: Routledge.
11. Cabraal, R. A., D. F. Barnes and S. G. Agarwal (2005). Productive uses of energy for rural development. *Annual Review of Environment and Resources*, vol. 30, pp. 117-144.
12. Carson, R. (1962). *Silent Spring*. Boston: Houghton Mifflin.
13. Cecelski, E. (1984). The Rural Energy Crisis, Women's Work and Family Welfare: Perspectives and Approaches to Action. *World Employment Programme Research Working Paper*, WEP 10/WP.35. Geneva: International Labour
14. Corbera, E., and K. Brown (2008). Building institutions to trade ecosystem services: marketing forest carbon in Mexico. *World Development*, vol. 36, No. 10, pp. 1956-1979.
15. Cripps, F., A. Izurieta and A. Singh (2011). Global imbalances, under-consumption and over-borrowing: the state of the world economy and future policies. *Development and Change*, vol. 42, No. 1, pp. 228-261.
16. Crola, J. D. (2011). Preparing for thin cows: why the G20 should keep buffer stocks on the agenda. *Oxfam Briefing Note*. Oxford: Oxfam International.
17. Dankelman, I., and J. Davidson (1988). *Women and the Environment in the Third World: Alliance for the Future*. London: Earthscan.
18. De Benoist, B., and others, eds. (2008). *Worldwide Prevalence of Anaemia 1993-2005: WHO Global Database on Anaemia*. Geneva: World Health Organization.
19. European Institute for Gender Equality (2012). *Review of the Implementation in the EU of Area K of the Beijing Platform for Action: Women and the Environment — Gender Equality and Climate Change*. Luxembourg: Publications Office of the European Union.
20. Evans, P. (1995). *Embedded Autonomy: States and Industrial Transformation*. Princeton, New Jersey: Princeton University Press.
21. Fairhead, J. (2001). International dimensions of conflict over natural and environmental resources. In *Violent Environments*, N. L. Peluso and M. Watts, eds. Ithaca, New York: Cornell University Press.
22. Fairhead, J., and M. Leach (1996). *Misreading the African Landscape: Society and Ecology in a Forest-Savanna Mosaic*. Cambridge: Cambridge University Press.
23. Grown, C., D. Elson and N. Cagatay. (2000). Introduction. Special issue: growth, trade, finance, and gender inequality. *World Development*, vol. 28, No. 7, pp. 1145-1156.
24. Guerrero, N. M., and A. Stock. (2012). Green economy from a gender perspective. Policy paper.
25. Guruswamy, L. (2011). Energy poverty. *Annual Review of Environment and Resources*, vol. 36, pp. 139-161.
26. Haddad, L. J., J. Hoddinott and H. Alderman, eds. (1997). *Intrahousehold Resource Allocation in Developing Countries: Models, Methods, and Policy*. Baltimore: Johns Hopkins University Press.
27. Hammerton, S., ed. (2013). *Decent work for domestic workers: Toward the ratification of ILO Convention 189 in Kenya, Namibia, Zambia and Zimbabwe*. Brussels: Solidar and International Federation of Workers' Education Associations.
28. Hammouya, M. (1999). *Statistics on Public Sector Employment: Methodology, Structures and Trends*. Working Paper SAP 2.85/WP.144. Geneva: International Labour Office.
29. Jackson, C. (1993). Doing what comes naturally? Women and environment in development. *World Development*, vol. 21, No. 12, pp. 1947-1963.

30. Jackson, T. (2011). Prosperity without Growth: Economics for a Finite Planet. London: Earthscan. King
- Dejardin, A. (2009). Gender (In)equality, Globalization and Governance. Working Paper No. 92. Geneva: International Labour Office.
31. Lam, N. L., and others. (2012). Household light makes global heat: high black carbon emissions from kerosene wick lamps. Environmental Science and Technology, vol. 46, No. 24, pp. 13531-13538.
32. Leach, M. (1992). Gender and the environment: traps and opportunities. Development in Practice, vol. 2, No. 1, pp. 12-22. Raworth, K. (2012). A safe and just space for humanity
33. Ray, I. (2007). Women, water and development. Annual Review of Environment and Resources, vol. 32, pp. 421-449.



## जलसंधारण काळाची गरज

प्रा. आर. यू. चोचंडे

बी.एस.एस. आर्ट्स, सायन्स , कॉर्म्स  
कॉलेज माकणी ता. लोहारा जि.उस्मानाबाद.

## प्रस्तावना:-

पृथ्वीवर ७१% भाग पाण्याने व्यापला आहे. पृथ्वीवरील जलावरणात ९३% भाग महासागराचा असून ५% जमीनीवरील पाण्याचा आहे. तसेच ध्रुवीय प्रदेशातील बर्फाच्या स्वरूपात २% पाणी आहे. ध्रुवीय अत्यल्प प्रमाणात पाणी वातावरणात असते पाण्याचे असंख्य उपयोग आहेत. त्यासाठी मानवी जीवनास पाण्याचा योग्य वापर करणे सर्वात महत्वाचे ठरते आणि विशेष करून महिलांनी याकडे लक्ष दिले गेले पाहिजे. शेताचे बांध, पाझर तलाव व पाणवठा शील पध्दतीचा अवलंब लोकसंख्या वाढीमुळे, उद्योग धंध्याच्या आणि जलसिंचन विकासांमुळे पाण्याच्या मागणीत वाढ होत आहे. पाण्याच्या उपलब्धतेवर मानवी उद्योग अवलंबून असतात जगातील सर्व लोकांना शुध्द स्वच्छ व आरोग्यदायी पाणीपुरवठा होणे आवश्यक आहे. त्यासाठी पाण्याच्या वापराचे वितरणाचे योग्य नियोजन करणे जरूरीचे आहे. पाण्याचा प्रत्येक थेंब महत्वाचा मानला पाहिजे पर्यावरणात निसर्गात, उपलब्ध असलेल्या ह्या जलसंधारणाचे योग्य संधारण होण्याची आज नितांत गरज आहे. भूपृष्ठावर उपलब्ध असलेल्या पाण्याचे संरक्षण, संवर्धन व विकास करणे व त्याची उपयुक्तता वाढवणे यासाठी पाण्याचे केलेले व्यवस्थापन म्हणजे जलसंधारण होय. निरनिराळ्या कारणांसाठी उपयुक्त असलेल्या पाण्याचा पूरवठा सर्वकाळ व नियमित व्हावा व तो कायदेशीर ठरावा यासाठी प्रकल्प राबविणे हे जलसंवर्धनाचे सर्वात महत्वाचे उद्दिष्ट आहे. आणि महत्वाचे स्त्रियांनी वृक्ष लागवड केली पाहिजे वृक्ष लागवडीवर वेगवेगळ्या तंत्राचा अवलंब केला पाहिजे.

## उद्दिष्टे:-

- १) पाण्याचा अतिरेकी वापर टाळणे.
- २) शेतीमध्ये योग्य त्या ठिकाणी पाण्याचा उपयोग करणे.
- ३) पाणी आडवा पणी जिरवा ही संकल्पना राबवणे.
- ४) शेतीमध्ये पाणी वेस्ट जाऊ न देता बांध घालणे.
- ५) जमीनीमध्ये जास्तीत जास्त पाणी कसे मुरेल याची काळजी घेणे.

## माहिती संकलनाचे स्रोत व अभ्यास पध्दती:-

प्रस्तुत विषयासाठी दुय्यम व प्राथमिक स्वरूपाची माहिती गोळा केली आहे. आर्थिक व सामाजिक समालोचन व जिल्हा कृषि विभाग, जिल्हा परिषद, अहवाल , मासिके व इंटरनेट इत्यादीमधून माहिती संकलीत केली.

## विषय विवेचन :-

जलसंवर्धनासाठी अनेक संकल्पना आपल्या समोर आहेत. पण त्या प्रत्यक्षरित्या राबवल्याजात नाहीत.

## Development + and Natural resources

- A) Forest (जंगल)
- B) Water (पाणी)
- C) Land (जमीन)
- D) People (लोक)

या वरिल घटकांचाही विचार केला पाहिजे.

जागतिक दृष्टीने विचार केला तर एकूण पाणी पिण्यायोग्य किती प्रमाणात आहे, व क्षारतायुक्त पाणी किती आहे. याकडेही लक्ष दिले पाहिजे आणि म्हणूनच पाण्याचा वापर किती व कशा पध्दतीने केला पाहिजे हे ही अभ्यासले पाहिजे.

## जलसंवर्धनासाठी कांही जलसंवर्धन तंत्र

- A) पाण्याचा अतिरेकी वापर टाळणे (Wastage Water) पाण्याचा अपव्यय टाळणे पर्यावरणाच्या दृष्टीकोनातून निकडीचे आहे आणि जगभर स्वच्छ पाणी उपलब्ध न होण्याची समस्या निर्माण होत असलेली दिसते हा समस्या नाहीशी करण्यासाठी आपण सर्वांनी प्रयत्न करणे गरजे आहे.

**B) वनांचा न्हास**

अलिकडे वनांचा न्हास होत असल्या कारणामुळे पावसाचे पाणी जमीनीच्या पृष्ठभागावरून वाहत जाते, आणि त्यामुळे भूगर्भाचे जलस्तर घटत जातो जंगलांचा नाश झाल्यामुळे पाणी मुरू शकत नाही.

जर भूगर्भीय जलस्तर वाढविण्यासाठी अनेक वर्षांचा कालावधी जावा लागेल.

**जागतिक दृष्टीने विचार केला तर**

A) Recycling of water of reanimation water

B) Israel ३०+३५-

C) Philippines ५०%

D) Singapore ९-

पाण्याची उपयोगिता मध्ये -पाणी उद्योगधंद्यासाठी १९० ते २०%

शेतीसाठी ७० + ७५%

E) पाण्याचा वापर केला जातो.

**C) जमीनीचा अधिक प्रमाणात वापर:-**

जमीनीचा अधिक प्रमाणात वापर केल्यामुळे मोठ्या प्रमाणात वनांचा न्हास होतो व त्याच बरोबर वाळवंटी प्रदेश वाढत जातात नंद्याच्या पात्रात बारमाही वाहणारे पाणी आडून नदया कोरडया पडतात.

पाण्याचा गैर वापर तसेच जलसाठयाच्या होणाऱ्या प्रदूषणामुळे पिण्याच्या पाण्याचे दूर्भिक्ष निर्माण झाले.

मानवी कल्याणासाठी जलसंवर्धन अत्यंत गरजेचे आहे.

**D) पर्जन्य जलसंधारण:-**

पावसाचे पाणी घराच्या छतावर तसेच घरावरील गच्चीवर पडणारे पाणी गोळा करून पाईपाद्वारे एका टाकीत गोळा करून पासाळयानंतर त्याचा उपयोग करणे.

आज बऱ्याच घरातील महिला हा प्रयोग करत असलेल्या दिसतात.

तसेच छतावर पडलेले पाणी गोळा करून घराच्या बाजूस ते मूरवणे.

पावसाचे साठविलेल्या पाण्यात शेवाळे व सूक्ष्म एकपेशीय प्राणी वाढतात हे सूक्ष्मसजीव रोगराई पसरविण्यास कारणी भूत ठरतात पावसाचे पाणी शुध्द स्वरूपात टिकवून ठेवणे व पाण्यात जतूनाशके औषधे टाकणे महत्वाचे ठरते. १८ सप्टेंबर हा दिवस World Water Monetary day म्हणून साजरा केला जातो.

शाश्वत पणाने पाणी टिकवायचे असेल तर पाण्याची जलसाठे स्वच्छ ठेवायला पाहिजे त्याची निरागणी राखली पाहिजे.

घरगुती पातळीवर ही पाण्याच्या वापरावर मोठया प्रमाणात उपयोग केला जातो हे सांडपाणी जवळपास ८०% होते. त्याचा देखील पूर्णवापर केला पाहिजे उदा. मुंबई सारख्या शहरामध्ये कोहीनूर या ठिकाणी सांडपाण्याच्या प्रकल्प राबवला जात आहे असे प्रकल्प सर्वत्र राबवले पाहिजे ज्या ठिकाणी सांडपाणी मोठया प्रमाणात आहे.

१) सोसायटीमध्ये राहणारे मानसी १३५ लिटर पाणी

२) चाळीमध्ये राहणारे मानसी ७० लिटर

३) झोपडपट्टी मध्ये राहणारे मानसी ४५ लिटर

लागते असे वेगवेगळया पध्दतीने पाण्याचा वापर केला जातो. हे जे वापरलेले सांडपाणी याचा पूर्णवापर केला पाहिजे.

तसेच शहरामध्ये मोठया-मोठया टाक्यामधून व पाईपमधून जवळपास १५ ते २० % पाण्याची गवळी होत असलेली दितसे. याकडेही लक्ष दिले पाहिजे.

शहरी भागात भुजलस्तर वाढवण्यासाठी अनेक संकल्पना राबवणे गरजेचे आहे. जसे उंगमापासून ते संगमापर्यंत ही संकल्पना राबवणे , बांधबदिस्तीकरणे , चरखोदणे , धावात्या पाण्याला चालायला लावा, चालल्या पाण्याला थांबलला लाव ही संकल्पना राबवणे गरजेचे आहे. पावसाचे पाणी प्रत्येक थेंब जमीनीमध्ये मूरवले पाहिजे हे प्रत्येक व्यक्तीस अशा प्रकारे जर पावसाच्या पाण्याचे नियोजन करणे महत्वाचे ठरले आणि रेनहार्व्स्टींग सारखे ही प्रकल्प सर्वांनीच राबवले पाहिजेत .

उदा. हिरवे बाजार येथे पावसाचे प्रमाण कमी असून देखील उपलब्धपाणी यांचे योग्य नियोजन त्यांनी केले आहे.

महाराष्ट्रातील कांही जिल्हयाची जलसिंचन साठे आहेत ती जनसिंचन साठे स्वच्छ व व्यवस्थीत ठेवणे महत्वाचे आहे. त्यामध्ये

	जिल्हा	भौ. क्षेत्र	जलसिंचन क्षेत्र	(लक्ष क्षेत्र )
१)	लातूर	७.१५	०.९५	०.७९
२)	उस्मानाबाद	७.२५	०.६४	०.६०
३)	जालना	७.८०	०.९१	०.६५
४)	औरंगाबाद	१०.९४	१.७६	०.६७
५)	बीड	११.१०	२.१५	१.३२.

एकूण भौगोलिक क्षेत्रापैकी जलसिंचन साठे जास्त प्रमाणपत्र असून देखील त्यापैकी कमी प्रमाणात जलसिंचन साठे पाण्याचा उपयोग करण्यासाठी योग्य आहेत.

#### सारांश :-

भारतामध्ये पावसाचे प्रमाण घटत आहे त्यातूनही इतर राज्यापैकी महाराष्ट्रतही अत्यल्प प्रमाणात पर्जन्यमान असलेले दिसून येते. पाण्याचा प्रश्न हा देशात भेडसावत आहे म्हणून समाजातील सर्वांनी मिळून जलसंवर्धनाची कास धरली पाहिजे. तसेच डोंगर माथ्यावर पाण्याची साठवण करता येईल यामुळे विहिरी तळे यांच्यातील पाणी जास्त काळ टिकवता येईल.

#### संदर्भग्रंथ :-

- १) पाणलोट क्षेत्र व व्यवस्थापन मासिक
- २) आर्थिक व सामाजिक -समालोचन
- ३) पर्यावरण शास्त्र - सौदी केलेच
- ४) विद्यापीठ अनुदान आयोग
- ५) महाराष्ट्र सिंचन विकास - मासिक २०१७



## हवा आणि पाणी प्रदूषण

प्रा. प्रज्ञा जे. कांबळे - शिरगांवकर

सहा. प्राध्यापिका, मराठी विभाग,  
वारणा महाविद्यालय, ऐतवडे खुर्द, ता. वाळवा, जि. सांगली

## प्रस्तावना :

आजच्या या वैज्ञानिक युगात माणसाला जसे अनेक वरदान मिळाले आहेत तसेच काही शापही मिळाले आहेत. प्रदूषण हा एक असा शाप आहे, जो वैज्ञानिक क्रांतीतूनच जन्माला आला आहे. आज सर्व जगालाच प्रदूषणाच्या या भयंकर समस्याला सामोरे जावे लागत आहे प्रदूषण हा आज मानव जीवनात एक गंभीर समस्यांचा विषय आहे. मागील काही वर्षांपासून प्रदूषण ज्या गतीने वाढत चाललेले आहे की त्यामुळे सर्व जीवांना अनेक अडचणींना सामोरे जावं लागत आहे.

हवा, पाणी आणि अन्न या माणसाच्या महत्त्वाच्या तीन गरजा आहेत. आपल्याला शुध्द हवा आणि शुध्द पाणी मिळणे हे आरोग्याच्यादृष्टीने खूपच महत्त्वाचे आहे. शुध्द हवा आणि शुध्द पाणी न मिळाल्यामुळे आज अनेक भयंकर रोगांना सामोरे जावे लागत आहे.

## प्रस्तुत संशोधन पेपरची उद्दिष्ट्ये :

प्रस्तुत संशोधन पेपरमध्ये हवा आणि पाणी प्रदुषित होणा-या घटकांचा विचार करून त्यावर उपाय सुचविणे.

## गृहितके :

औद्योगिक विकासांमुळे, मानवाचा पर्यावरणाचा -हास होतो. ह्या संशोधन पेपरसाठी आवश्यक असलेली प्राथमिक माहिती म्हणून निरीक्षण, पर्यावरण तज्ञ, नागरिक, रूग्ण, कामगार व माहितीचे स्रोत व इतर अशा विविध क्षेत्रातील प्रतिसादकांचा समावेश करण्यात आला आहे.

## प्रदुषण म्हणजे काय □

प्रदुषण म्हणजे जीवजंतू नष्ट करणारे किंवा विस्कळित करणारे घटक जे वातावरण वायू, जल आणि भूप्रदेशात मिसळतात. प्रदूषणाचे पुढील प्रकार आहेत.

१. वायू प्रदूषण
२. जल प्रदूषण
३. ध्वनि प्रदूषण
४. माती प्रदूषण

## १□वायू प्रदूषण :

नैसर्गिक हवेतील जे पदार्थ अथवा घटक मानवी, प्राणी, पक्षी, वनस्पती, उपयुक्त जंतू यांच्या आरोग्यास व जीवनास हानिकारक आहेत. तसेच जे हवामान बदलास कारणीभूत आहेत त्यांना प्रदूषण घटक असे म्हणतात.

सल्फर डायॉक्साईड ( $SO_2$ )□

सल्फर डायॉक्साईड जेव्हा श्वसनावाटे नाकफुड्यांमध्ये जातो तेव्हा श्वसन नलिकेतील पेशी सल्फर डायॉक्साईडला फुफ्फुसापासून पोहोचण्यापूर्वी कफातील पाण्यात विरून टाकतात जर याचे प्रमाण जास्त झाले तर नलिकेत अजून जास्ती कफ होतो व सर्दी होते.

नायट्रोजन ऑक्साईड व डायॉक्साईड ( $NO$  and  $NO_2$ )□

नायट्रोजन डायॉक्साईडसुद्धा सल्फर डायॉक्साईडप्रमाणे श्वसननलिकेत प्रवेश करतो परंतु याची पाण्यात विरण्याची क्षमता कमी असते व तो बराचसा फुफ्फुसापर्यंत पोहोचतो.

यामुळे जास्तीत जास्त कफनिर्मिती होते व सर्दी होते इतर लक्षणांमध्ये त्वचा कोरडी पडते डोळे चुरचुरणे, असे प्रकार घडतात. वाहतुकीच्या वर्दळीमध्ये नायट्रोजन डायॉक्साईडमुळेच सर्दी वाढण्याचे प्रकार घडतात. दिर्घ काळानंतर सातत्याच्या सर्दीमुळे दमा ताप हे नेहमीचे आजार बनून जातात.

**ओझोन : ( O<sub>4</sub> )**

दिवसभर हवेत ओझोन व नायट्रोजन ऑक्साईडचा कमी जास्त होण्याचा खेळ चाललेला असतो ओझोनच्या सातत्याच्या मा-यामुळे कालांतराने फुफ्फुसे दुर्बल होऊन दम्यासारखे रोग वाढीस लागतात .

**व्होलेटाईल ऑर्गॅनिक कंपाऊंड ( VOC )**

विविध रसायने व रासायनिक उत्पादने यांच्या वापराने या उत्पादनांचे बाष्पीकरण होते व व्हीओसी तयार होतात . यातील काही घटक हे मानवी आरोग्यास सरळपणे घातक असतात तर काही सुरक्षितपणे असतात . बहुतांशी व्हीओसीचे सूर्यप्रकाशात ओझोनमध्ये रूपांतर होऊन जाते व ओझोन अंततः घातक प्रदूषण घटकाचे काम करतो . पेट्रोलपंपावरील गाडी भरताना उडणारे पेट्रोल, घराला रंग देताना थिनर व ऑईलपेंटचा वापर इत्यादी गोष्टी वातावरणातील व्हीओसी वाढवतात .

**कार्बन मोनॉक्साईड ( CO )**

आरोग्यास अत्यंत घातक असा हा वायू अपूर्ण ज्वलनाने तयार होतो वीटभट्या, छोटे छोटे तसेच मध्यम व मोठे विज निर्मितीसच वाहनांच्या इंजिनमधून हा वाहेर पडतो . आपल्या रक्तामध्ये ऑक्सिजन वाहण्याचे काम करणारे हिमोग्लोबीनमध्ये ऑक्सिजन ऐवजी मिसळून जातो व शरिरातील सर्व भागात पोहोचतो त्यामुळे हा वायू अत्यंत विषारी असून काही मिनिटे सातत्याने संपर्कात आल्यास मृत्यूही ओढवू शकतो हे अतिरोकाच्या परिस्थितीत होऊ शकते परंतु कमी संपर्कात किंवा हवेतील कमी प्रमाणात कार्बन मोनॉक्साईड असल्यास चक्कर येणे, डोळ दुखणे विचारक्षमता अथवा कार्यक्षमता कमी होणे असे प्रकार घडतात .

**वायू प्रदूषणाचा आरोग्यावरील परिणाम :**

वायू प्रदूषणाचा सर्वात घातक परिणाम श्वसनसंस्थेवर होतो वर नमूद केल्याप्रमाणे विविध प्रदूषक घटके श्वसन व्यवस्थेवर हल्ला चढवतात ओझोन, नायट्रोजन डायॉक्साईड हे फुफ्फुसांवर अतिशय घातक परिणाम करतात .

**निसर्गातील इतर घटकांवर परिणाम :**

केवळ मनुष्यच नव्हे तर निसर्गातील इतर घटकांवर प्रदूषणाचे विपरित परिणाम होतात सल्फर डायॉक्साईड व नायट्रोजन डायॉक्साईडमुळे आम्लधर्मी पावसाची निर्मिती होते व त्याचे विपरित परिणाम जमिनीवर व पिकांवर होतो .

**इतर परिणाम :**

रबर हे ओझोनच्या संपर्कात आल्यामुळे ते कडक बनते व त्याचे आयुष्य कमी होते तसेच ओझोनच्या अस्तित्वाने कपड्यांचे रंगही गाड्यांचे रंगही फिके होतात . ताजमहाल, ग्रीसमधील अक्रोपोलिस या व जगातील इतर महत्त्वाच्या वास्तूंचे सौंदर्यदिग्शील वायूप्रदूषणामुळे कमी झाले आहे साध्या बांधकामाचेही आयुष्य कमी होते . कार्बन डायॉक्साईडच्या सातत्याच्या उत्सर्जनाने जागतिक तापमानवाढीची समस्या भेडसावणे चालू झाले आहे .

**उपाय योजना :**

वायू प्रदूषणात प्रदुषके एकाच जागी तयार होतात केंद्रीय उत्सर्जन ( Point Sources ) अथवा सर्वत्र थोड्या थोड्या प्रमाणात सार्वत्रिक उत्सर्जन ( Diflused Sources ) तयार होतात केंद्रीय उत्सर्जन होण्याचे उदाहरण म्हणजे औद्योगिक ठिकाणे, वीजनिर्मिती कारखाने, तर सार्वत्रिक उत्सर्जनाचे उदाहरण आपली वाहतूकव्यवस्था धरता येईल जर प्रदुषण एकाच जागी होत असेल तर त्यावर नियंत्रण मिळवणे सोपे असते परंतु सर्वत्र थोड्या थोड्या प्रमाणात होणा-या सार्वत्रिक उत्सर्जन प्रदूषणावर नियंत्रण मिळवणे हे खूपच अवघड आहे विविध प्रकारचे कडक नियम व कायदे यांनी औद्योगिक क्षेत्रातून होणा-या प्रदूषणावर विकसित देशात व-याच प्रमाणात नियंत्रण मिळवले आहे परंतु भारत व इतर विकसनशिल देशात अजूनही म्हणावे इतके यश मिळालेले नाही . कायद्याची कडक अंमलबजावणी मधील त्रुटी, तंत्रज्ञान वापरण्याबद्दल असलेली आर्थिक उदासिनता व माहितीचा अभाव ही प्रमुख कारणे आहेत सार्वत्रिक उत्सर्जनाच्या प्रदूषणावर तंत्रज्ञानातील सुधारणा व उर्जेचा कमी वापर यातूनच सुधारणा करता येते सध्याच्या विकसनशील देशांची वाढती अर्थव्यवस्था व ऊर्जेच्या वाढता वापर तसेच विकसित देशातील दरडोई असलेला मोठ्या प्रमाणावरील वापर यामुळे ऊर्जेचा वापर कमी होणे सध्यातरी अशक्य दिसत आहे त्यामुळे तंत्रज्ञानातील सुधारणा किंवा प्रदूषणरहित नवीन वस्तू ऊर्जास्रोताचा शोध यावर अवलंबून राहणे आवश्यक आहे .

वाहनांमध्ये तंत्रज्ञान सुधारण्यास मोठा वाव आहे . विविध प्रकारचे कॅटॉलिटिक कन्व्हर्टर, फिल्टर यांच्या वापराने वाहनातून वाहेर पडणा-या प्रदूषणावर नियंत्रण मिळवता येते . परंतु कोणत्या प्रकारच्या ऊर्जास्रोताने जागतिक तापमान वाढ रोखता येईल यावर अजून तरी समाधानकारक उत्तर सापडलेले नाही .



**२. जल प्रदूषण :**

जल प्रदूषण म्हणजे पाण्याच्या स्रोतांचे प्रदूषण जलप्रदूषण ही एक मानवनिर्मित समस्या आहे . पाणी हे मानवाच्या मुलभूत गरजांपैकी एक आहे . औद्योगिक वसाहती व कारखान्यातील रासायनिक पदार्थ कोणत्याही प्रक्रियेविना नदी,नाले व इतर जलस्रोतांमध्ये सोडले जातात नदीत कपडे धुणे, भांडी घासणे यामुळे रासायनिक प्रक्रिया केलेल्या वस्तू पाण्यात मिसळल्याने, पाणी मृत पावल्याने पाणी मोठ्या प्रमाणावर प्रदूषित होते .

**जल प्रदूषण आणि आरोग्य :**

पाण्यातून होणा-या संसर्गामुळे मृत्यूमुखी पडणा-यांचे प्रमाण सर्वाधिक आहे विशेषतः पाच वर्षांच्या आतील मुले अशा संसर्गा ला बळी पडतात जगण्यासाठी सजीवांना पाण्याची अत्यंत गरज असते . जगात उपलब्ध असलेल्या पाण्यापैकी फक्त १ ते १.५% पाणीच पिण्यायोग्य आहे कारण पृथ्वीवरील एकूण पाण्यापैकी जवळ जवळ ९८% पाणी हे समुद्र आणि वर्षांच्या स्वरूपात आहे . त्यामुळे पिण्यायोग्य पाणी जपून वापरणे गरजेचे आहेच आणि पिण्यायोग्य पाण्यात प्रदूषके मिसळण्यापासून थांबवणेसुद्धा गरजेचे आहे . जल प्रदूषण हे आपल्यासाठी खूप हानिकारक आहे .

**जलप्रदूषणाची कारणे :**

- औद्योगिक रासायनिक पदार्थ पाण्यात सोडल्यामुळे
  - सांडपाणी, मैलायुक्तपाणी जलाशयात सोडल्यामुळे
  - रासायनिक खते, किटकनाशके पाण्यात मिसळल्यामुळे
  - पाण्यातील जीव मृत होऊन कुजल्यामुळे
  - कचरा किंवा तत्सम पदार्थ पाण्यात टाकल्याने
  - जनावरे, कपडे, भांडी नदीच्या ठिकाणी धुतल्याने
  - मृत जनावरे नदीत टाकल्याने
  - रासायनिक रंगकाम केलेल्या प्लास्टर ऑफ पॅरिसपासून बनविलेल्या मुर्तीच्या विसर्जनामुळे पाण्याचे प्रदूषण होते .
  - जलप्रदूषणामुळे पाण्यामध्ये जीवाणूंची उत्पत्ती होते असे जीवाणूयुक्त पाणी पिल्याने अनेक रोग उत्पन्न होतात . यामध्ये अतिसार उलटी, कावीळ, विविध प्रकारचे ताप, पटकी, मलेरिया, खोकला, सर्दीसारखे विकार होतात .
  - रासायनिक पदार्थयुक्त पाणी सेवन केल्यास त्यांचा अत्यंत वाईट परिणाम आपल्या किडण्यांवर होतो . किडनी निकामी होणे यासारखे गंभीर व्याधी उत्पन्न होतात .
  - समुद्रामध्ये तेलगळती झाल्यामुळे समुद्रातील जलचर मृत्यूमुखी पडतात .
- अशा पध्दतीने वरील सर्व कारणामुळे हे पाणी चौहोबाजूंना प्रदूषणाच्या विळख्यात सापडले आहे .

**उपाय :**

पाणी प्रदूषित, दुषित होऊ नये म्हणून प्रत्येकाने हातभार लावला पाहिजे शेतक-यांनी नदी नाले ओढयातल्या पाण्यात किड रोग नियंत्रणाची औषधे रसायने सोडू नयेत पंप वगैरे धुवू नये त्याची दक्षता घ्यावी .

केमिकल कारखान्यांनी अगर इतर कारखान्यांची आपले सांडपाणी नदी, नाल्यात न सोडता त्यांचे शुध्दीकरण करून शेतीसाठी झाडांसाठी वापरावे याची उत्तम उदाहरणे दुध डेअ-यांनी घालून दिलेली आहेत . सोनाई दूध संघाने सांडपाण्यावर हजारो फळझाडं उभी करून एक उत्पादनाचे साधन उभे केले आहे . कागद आणि साखर कारखान्यातील मळी आणि इतर द्रवरूप पदार्थ बेजाबदारपणे कुठेही सोडू न देता त्यावर प्रक्रिया करून वापर करावा म्हणजे पाणी दुषित व्हायचे टळेल .

पिण्याच्या पाण्याचे शुध्दीकरण करू नये मग ते पिण्यासाठी वापरावे अशी आजची सगळीकडे स्थिती निर्माण झाली आहे . पाणी उकळून घेणे सर्वात उत्तम . पाणी तपासणी अहवालानुसार त्याचे शुध्दीकरण करून घेऊनच पिण्यासाठी वापरावे .

किड रोग तन नियंत्रणासाठी जी औषधे मारली फवारली जातात त्यांच्याबाबतीतही ती पाण्याद्वारे मातीतून भूगर्भात पाण्याला दुषित करणार नाहीत अगर भूपृष्ठावरील जलसाठयाला प्रदूषित करणारे नाहीत याची दक्षता घ्यावी .

पाणी प्रदूषण हे १००% मानवनिर्मित आहे हे निसर्गनिर्मित नाही म्हणूनच प्रत्येकाने मी पाणी दुषित करणार नाही असे ठरवून स्वच्छ, शुध्द पाणी या मोहिमेत सहभाग घेतला तर नक्कीच पाण्याचे प्रदूषण कमी करू शकू आणि आपणच आपल्यासाठी स्वच्छ पाणी, शुध्द पाणी मिळवू शकू नद्या व तलावामधून कचरा वाहून नेण्यास परवानगी देऊ नये .

शेतीमध्ये रासायनिक खताएवजी सेंद्रीय शेतीसाठी प्रोत्साहन दिले पाहिजे .

जलमार्ग आणि किनारे यांची नियमित स्वच्छता केली पाहिजे आणि प्लॅस्टिकचा वापर थांबवला पाहिजे .

### निष्कर्ष :

जलप्रदूषण आता आणीबाणीवर पोहोचले आहे आणि म्हणून आपल्याला त्वरीत काही प्रमुख पावले उचलण्याची गरज आहे आणि अशा प्रकारच्या कामात कोणत्याही प्रकारचा विलंब घातक ठरू शकतो .

आपल्याला पाणी पिण्यासाठी, आंघोळीसाठी, सिंचन इत्यादीसाठी वापरावे लागते आणि असे पाणी विषारी सडलेले पाणी, असंपृक्त पदार्थ आणि इतर घाण प्रवाहित पाण्यामध्ये आले तर पाण्याची गुणवत्ता घटते हे समजणे महत्त्वाचे आहे की गलिच्छ पाणी हानिकारक जीवाणूंचे वाहक आहे जे आपल्या आरोग्यासाठी हानिकारक आहे म्हणून आपण नद्या आणि इतर जलसंसाधनांच्या स्वच्छतेकडे बारकाईने लक्ष दिले पाहिजे . जल प्रदूषण विरोधात व्यापक सामाजिक जागरूकता अभियान सुरु करण्याची गरज आहे . पाणी हे अमृतच आहे आणि म्हणूनच पाणी स्वच्छ ठेवणे हे आपले कर्तव्य आहे .

हया वैज्ञानिक युगात प्रदूषण कमी करणेसाठी एक मात्र उपाय म्हणजे सामाजिक जागृतता हा आहे . मिडीयाला ही या संदर्भात संदेश देणे अतिअवश्यक आहे समूहीक प्रयत्नातूनच प्रदूषण सारख्या वैश्विक समस्येला नियंत्रित केले जावू शकते अन्यथा आपल्या येणा-या पिढीला अतिशय गंभीर समस्येला सामोरे जावे लागेल .

### संदर्भ :

१. प्रदूषण एक समस्या - डॉ. किशोर पवार
२. प्रश्न आणि प्रश्न - डॉ. अनिल अवचट

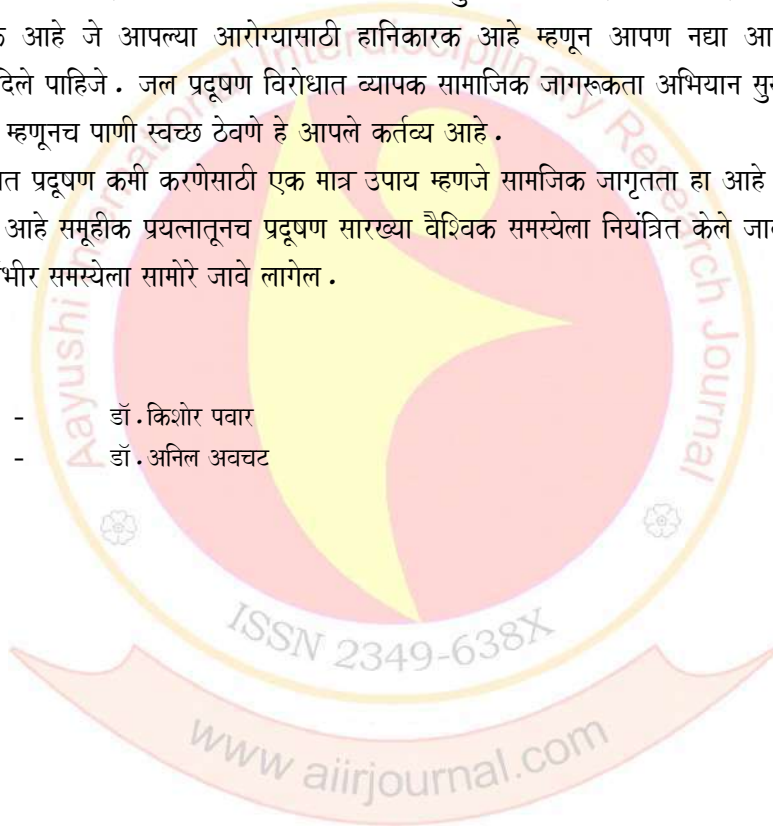

## ‘तळ ढळताना या काव्यसंग्रहातून अभिव्यक्त झालेल्या पर्यावरणविषयक जाणिवा’

प्रा. भीमराव खं. वानोळे

सहाय्यक प्राध्यापक, मराठी विभाग  
यशवंतराव चव्हाण वारणा महाविद्यालय, वारणानगर.

## प्रस्तावना

मराठी साहित्यामध्ये दलित साहित्याचा प्रवाह अत्यंत जोरकसपणे अभिव्यक्त होत आलेला आहे. या साहित्यप्रवाहातील समकालीन काळाचे प्रतिनिधीत्व उजागर करणाऱ्या कवींमध्ये कवी लहू कानडे यांचे नाव अग्रक्रमाने घ्यावे लागेल. त्यांच्या काव्यसंग्रहात सर्वहारा समाज, कष्टकरी, वंचित, शोषित समाजाच्या व्यथा वेदना व दुःख मांडलेले आहे. कवी प्रशासकीय सेवेत असल्यामुळे तेथील अनेक समस्यांचे चित्रणही त्यांची कविता मांडते. लहू कानडे यांचे अनेक काव्यसंग्रह प्रकाशित झालेले आहेत. त्यामध्ये क्रांतीपर्व (१९८३), टाचा टिभा (१९९६) व तळ ढळताना (२०१२) हे काव्यसंग्रह आहेत. त्यांच्या क्रांतीपर्व व टाचा टिभा या काव्यसंग्रहांचे अनुवाद हिंदीसह अन्य भाषांमध्ये झालेले आहे. अनेक विद्यापीठांच्या अभ्यासक्रमामध्ये या काव्यसंग्रहांचा समावेश झालेला आहे. तळ ढळताना या काव्यसंग्रहाची पहिली आवृत्ती २०१२ साली प्रकाशित झालेली असून मार्च २०१४ पर्यंत या काव्यसंग्रहाच्या तीन आवृत्या निघाल्या. हे या काव्यसंग्रहातील आशयाचे व विषयाचे मोठेपण आहे. सध्या या काव्यसंग्रहाचा समावेश शिवाजी विद्यापीठातील मराठी विषयाच्या बी. ए. भाग २ मधील अभ्यासक्रमामध्ये झालेला आहे. हा काव्यसंग्रह एकूण चार विभागांमध्ये विभागलेला असून पृष्ठांची संख्या १०२ इतकी आहे. काव्यसंग्रहाच्या मुखपृष्ठावरील चित्र अत्यंत बोलके असून परंपरागत दारिद्र्यावस्थेमध्ये, व्यवस्थेने पिचलेल्या समाजाचे चित्रण करणारे आहे. तसेच मलपृष्ठावर छापलेला आशय सामाजिक पर्यावरणाची जाणीव उजागर करणारा आहे. सत्य, विवेक, मानवता इत्यादी धारणांची जपणूक व रूजवणूक करून नवीन नवमानवाची निर्मिती कवीला अपेक्षित आहे.

## शोधनिबंधाची उद्दिष्टे

१. ‘तळ ढळताना या काव्यसंग्रहातून अभिव्यक्त झालेली पर्यावरणविषयक जाणीव स्पष्ट करणे.
२. काव्यसंग्रहातील पर्यावरणविषयक जाणीवांचे महत्त्व स्पष्ट करणे.

## ‘तळ ढळताना या काव्यसंग्रहातून अभिव्यक्त झालेल्या पर्यावरणविषयक जाणिवा

भारतामध्ये गेल्या तीन चार दशकांपासून पर्यावरण हा शब्द विशेषरूपाने वापरला जात असला तरी निसर्ग व पर्यावरणविषयक जाणिवांची जपणूक प्राचीन काळापासून रूढ असलेली दिसते. मानव आणि निसर्ग यांचे नाते अतूट असून ते परस्परांचे अविभाज्य भाग असल्याचे वर्णन अनेक प्राचीन ग्रंथातून आलेले आहे. माणूस व निसर्ग यांच्यातील ऐक्यभाव अनेक संत महात्म्यांनी आपल्या साहित्यातून व प्रबोधनातून उजागर केलेला आहे. निसर्गातील कोणतीही वस्तू, पदार्थ मानवासाठी अत्यंत उपयुक्त असल्याने त्याचे जतन व संवर्धन करणे गरजेचे आहे. मानवाकडून होत असलेला निसर्गाचा नाश थांबविणे अत्यंत गरजेचे आहे. “निसर्ग पर्यावरणाविषयी एकेकाळी असणारा माणसाच्या मनातील आदर जागविण्याचे आणि पर्यावरणचे प्रश्न सोडविण्याचे मार्ग दाखविण्याचे सामर्थ्य भारताच्या सांस्कृतिक वारशात आहे. हा वारसाच निसर्ग पर्यावरणाकडे बघण्याची, त्याच्याशी स्वतःला जोडून घेण्याची आणि त्याचे मूल्य जगण्याची दृष्टी देऊ शकतो.”१ निसर्ग हा अदभूत आहे. तो तारक आहे. त्यामुळे त्याचे जतन करण्याची धारणा, विचार वर्तमान मानवापर्यंत पोहचविण्यासाठी अनेक साधने आणि माध्यमे प्रयत्नशील असलेली दिसतात. त्यापैकी अत्यंत प्रभावीपणे साहित्याने पर्यावरणाचे बदलत चाललेले रूप व त्यांची गंभीरता मांडलेली आहे. लहू कानडेची कविता ही मानवी जीवनाच्या हरएक प्रश्नांना वाचा फोडण्याचे काम करीत असलेली दिसते. मानवता, समता, न्याय, बंधुता, वैज्ञानिकता इत्यादी अनेक मूल्यांबरोबरच पर्यावरणाची जाणीव अभिव्यक्त करते. कवी लहू कानडे यांचे बालपण अत्यंत हलाखीत गेले असल्याची जाणीव त्यांच्या काव्यात कायम असलेली दिसते. आपल्या वडीलांच्या जगण्यात सातपुडा पर्वतांचे महत्त्व सांगताना कवी म्हणतो,

“बाप बी कधी रंगात आला  
की सातपुड्याच्या रांगातील गोष्टी सांगायचा  
किरी जंगलात उंच पहाडावर  
राहणाऱ्या दाढीवाल्या संन्याशाची  
त्यान दिलेल्या साबरी विद्येची  
भूक भागविणाऱ्या कंदमुळांची”२

निसर्ग संतुलनाचे नियमन निसर्गाने केलेले आहे. पर्वतरांगा, उंच उंच शिखरे, झाडे, पशूपक्षी, चारा पाणी इत्यादी सर्व गोष्टी निसर्ग येथील जीवांना मुक्तपणे देतो. कवीच्या वडीलाला जेव्हा काही कारणाने गाव सोडावे लागले; तेव्हा सातपुड्याच्या पर्वतरांगांनी त्याला स्वीकारले. तेथे वस्ती करणाऱ्या जीवांना जगविण्याचे काम सातपुडा पर्वताने म्हणजेच निसर्गाने आपसूकपणाने केलेले आहे.

निसर्ग आपल्या प्रत्येक कृतीतून पर्यावरणाचे संतुलन राखत असतो. निसर्गाकडे चला हा संदेश संत महात्म्यांनी आपणास पूर्वीच दिलेला आहे. तेथे वास्तव्य करणाऱ्या कंदमुळे व विविध स्वरूपाचे फळे हे निसर्गाने दिलेले वरदान आहेत.

“सातपुडा

चिवचिवणाच्या आकाशलक्षी रंगीत पंखांचा निवारा  
झाडाझुडपांतून सळसळणारा जिवंत जंगल वारा  
निरागस उघडयानागडया मूळ निवासींचा सहारा अन  
महूच्या फुलांनी बेधुंद झालेला हिरवाकंच पसारा”३

सातपुडयाच्या अथांग, उंच असलेल्या सात पर्वतरांगा म्हणजे एक प्रकारचे जसे आपले वैभव आहे. त्याप्रमाणेच त्या पर्वताने कितीतरी जीवांना आसरा दिलेला आहे. त्यामध्ये अनेक रंगीबेरंगी पक्षी आहेत, प्राणी आहेत, आदिपासून वास्तव्य करणारे आदिवासी आहेत व असंख्य विविधांगी जातीची झाडे आहेत. या झाडाझुडपातून वाहणारा सदैव जिवंतपणाना संदेश पोहचविण्याचे काम करित आहे असे कवीला वाटते. त्यांनी निसर्गचक्र सांभाळले आहे. त्यामुळे पर्यावरणाचे योग्य रक्षण होत आलेले आहे. या पर्वताचे महत्त्व आदिवासींच्या जगण्यात आणि जीवनात अनेकांगी स्वरूपाचे आहे. ते निसर्गाशी, पर्वताशी, तेथील झाडांशी, प्राण्यांशी वेगळे नाते जोडून जीवन जगत असतात. त्याविषयीच्या आदिवासींच्या मनातील भावना कवीला आदिवासी पाडयावर ऐकायला मिळतात,

“झाडं पहाडाची लेकरं हायेत सायब  
उनवान्यात, पावसाच्या माच्यात बी  
हा डोंगर मरू नाय देत त्यास्नी  
मायबाप होऊन गुराढोरांसगत आमस्नी  
त्योच सांभाळतो आमचो आबो”४

कवी प्रशासकीय अधिकारी म्हणून सातपुडा पर्वतरांगात येतो. तेथील समस्या जाणून घेण्यासाठी बहूल असलेल्या आदिवासी पाडयावार जातो. त्यावेळी तेथील आदिवासीकडून निसर्गाची, झाडाची मानवी स्वार्थापोटी कत्तल केली जात आहे याची माहिती मिळते. याशिवाय डोंगर, झाडे, पशूपक्षी, आदिवासी यांच्यामधील नातेसंबंधही लक्षात येतात. ऊन, वारा, पाऊस यासारख्या अनेक आपत्या आल्यातरी आम्हाला हा डोंगर वडीलकीच्या नात्याने सांभाळतो असे येथे वास्तव्य करणाऱ्या आदिवासींचे ठाम मत आहे. ही पर्यावरणविषयक प्रगल्भतेची जाणीव आदिवासी अगदी प्राचीन काळापासून जोपासत आलेला आहे.

निसर्ग आणि मानवी जीवन परस्पराला कसे पूरक आहेत याचे चित्रण कवी आदिवासी आणि सातपुडा पर्वत यांच्या जीवनजाणिवातून मांडतो. आदिवासी हा निसर्गात जन्मतो व त्याच्या आसऱ्याने आपले संपूर्ण जीवन व्यतीत करतो. त्याला उपयुक्त असलेले अनेक साधने, अलंकार, हत्यारे जंगलातूनच प्राप्त झालेले आहेत. त्यामुळे त्याच्या जीवनात निसर्गाला अत्यंत महत्त्वाचे स्थान प्राप्त झालेले आहे. जेव्हा त्याला आवश्यक असणाऱ्या गोष्टी प्राप्त होतात तेव्हा तो आनंदी होतो. त्याचा आविष्कार नृत्याच्या माध्यमातून व्यक्त करतो. खरं तर कवी या जगण्याला निसर्गपूरक म्हणतो. अडाणी म्हणणाऱ्या लोकांना तो समजवू पाहतो की, हेच खरे जगणे आहे. यातून हा आदिवासी समूह पर्यावरणाचे रक्षण व संवर्धन करित आहे.

“लेकरं गमावलेल्या बुढयाचा  
तळतळाट बी लई वंगळ अस्तो सायब  
राजाला बी तुरूंगात जावं लागतं  
अन पार व्हत्याचं नव्हतं व्हतं!”७

आज सर्वत्र पर्वत, जंगलं नष्ट होत आहेत. अमाप प्रकारची झाडांची कत्तल होत आहे. त्यामुळे आदिवासींचे जगणे अवघड होत चालले आहे. झाडे व पर्वत यांचे नाते लेकरू व बापाचे असल्याचे वर्णन केलेले आहे. परंपरागत काळापासून समाजामध्ये रूतून राहिलेल्या अनेक चांगल्या संदर्भांचा उल्लेख करताना टळतळाटाचा संदर्भ उजागर होतो. रावाचा रंक होण्यास फार वेळ लागत नाही. ही गोष्ट पर्यावरणाची नासधुस करणाऱ्या व बिघाड निर्माण करू पाहणाऱ्या लोकांनी लक्षात घेणे समग्र मानवजातीसाठी अत्यंत आवश्यक झालेले आहे. तसे झाले नाही तर त्याचे परिणाम आपणास निश्चितच भोगावे लागतील असे वाटते. कवी पर्यावरणीय संतुलनावरोबरच समाजिक पर्यावरण समान पातळीवर यावं यासाठी उपाययोजना सूचित करताना म्हणतो,

“बापा,

मी पुकारलाय जिहाद  
करीन म्हन्तोय हागंदरीमुक्त गाव  
गोरगरिबांना पिडणाऱ्या दुःखाचं

समूळ उपटून टाकीन म्हन्तोय नाव  
फिरवीन म्हन्तोय सार्वजनिक संडासावर बुलडोझर  
भूरळ घालत नाही मला  
गू घाणीवर जगायला सांगणार गाजर”८

प्राचीन वर्णव्यवस्थेने ग्रासलेला शूद्र समजला जाणारा मानवी समूह अत्यंत घाणीचे कामे करित आलेला आहे. हे परंपरागत लादले गेलेले दुःख कवी नाकारण्यासाठी विविध उपाययोजनांचा आधार घेताना दिसतो. हागंदरीमुक्त गाव झाले तर अस्वच्छता, घाणीचे साम्राज्य नष्ट होईल नाही. त्यामुळे पिचलेल्या लोकांना ते काम करण्याची गरज उरणार नाही. सामाजिक संतुलन साधल्यामुळे मानवता प्रस्थापीत होईल असेही कवीला वाटते.

मानवाच्या विषमतावादी जगण्यावर कवी प्रखड शब्दात कोरडे ओढतो. कवी मानवी समाजवादी पर्यावरणाचे संतुलन साधून मानवताद निर्माण करू पाहतो. तळ ढवळताना या काव्यसंग्रहातून सामाजिक, सांस्कृतिक, राजकीय पर्यावरणाची चर्चा विविधांगी मार्गाने व भाषिक अवकाशाच्या रूपाने कवीने मांडलेली आहे.

### निष्कर्ष

२. ‘तळ ढवळताना हा काव्यसंग्रहात वर्तमान काळातील ग्रामीण, आदिवासी, शहरी, कार्यालय, लोकशाहीचा आपल्या फायदयाप्रमाणे वापर, वर्णव्यवस्थेचा अभिजातपणा अशा अनेक समस्यांचा वेध घेतलेला आहे.
३. पर्यावरणाचे रक्षण व संवर्धन करणे ही काळाची गरज आहे हे विचार तळ ढवळताना हा काव्यसंग्रह उजागर करतो.
४. पर्यावरणाचे रक्षण हेच मानवाचे रक्षण ठरेल ही भूमिका हा काव्यसंग्रह ठामपणे मांडतो.
५. सामाजिक पर्यावरण हे समानतावादी, मानवतावादी निर्माण झाले तर समग्र मानवी समूहाला ते पोषक ठरेल असे विचार काव्यसंग्रहातून अभिव्यक्त होतात.

### संदर्भ

१. गजेंद्रगडकर वर्षा, पदमगंधा प्रकाशन,पुणे, पृ. क्र. १४.
२. कानडे लहू, तळ ढवळताना, लोकवा मय गृह, मुंबई, तिसरी आवृत्ती २०१४, पृ. क्र. ०६
३. तत्रैव, पृष्ठ क्र. ०७
४. तत्रैव, पृष्ठ क्र. ०८
५. तत्रैव, पृष्ठ क्र. १०
६. तत्रैव, पृष्ठ क्र. ०८
७. तत्रैव, पृष्ठ क्र. २०,२१

**Fauna Of Amphibia From Poladpur Tehsil, Western Ghats, Maharashtra, India.****B.P.Tingare**

Dr.Babasaheb Ambedkar College, Mahad. Dist-Raigad (M.S) India.

Email; drbptingare@gmail.com

**Abstract**

We survey the selected spots of Poladpur tehsil of Raigad district of Western Ghats from June 2013 to 2014 during rainy season. Western Ghats of India is well known for biodiversity hotspots. The selected spots are well known biodiversity hot spots in Poladpur Tehsil of Raigad district of Western Ghats. The ecological parameters viz. Rain fall, temperature, humidity etc. are favorable for inhabitations of amphibians. We reported 13 species of amphibians belongs to 5 families 6 genera in Mangoan Tehsil of 342 species of amphibian found in India belongs to 15 families.

**Key Words:** Amphibian fauna, Poladpur tehsil Western Ghats, etc

**Introduction:-**

India has two well known as biodiversity hotspots amongst the 25 biodiversity hotspots of the world. Out of two, western Ghats is one of the well known for biodiversity hotspots in India. As far as Western biodiversity is concerned the southern part of the Western Ghats is more explored than the northern Western Ghats, Maharashtra. As far as Western part of Poladpur tehsil is concerned Karje, Umarath, Kapada, Poladpur and Kangori are well known biodiversity hotspots in Kokan region of Poladpur Tehsil. The survey of Indian amphibian fauna has been developed by many herpetologists such as Annandale, Broulanger Daniel, Pillai, Dutta etc. Sekar (1989) Ravichandran and Pillai (1990), Daniel (1992), Dutta (1992), Padhy et al (2000, 2002) Frost et al (2006), Dinesh et al, (2011) and Jadhav et al (2007).

**Study Area:**

Poladpur Tehsil in Raigad district of Maharashtra lies between latitude 17° 55' and 18° 05' N and longitude 73° 50' and 74° 30' E. The famous Karje locate at latitude 17° 55' N and longitude 73° 05' E and 74° 05' E and Umarath and Kapada situated at latitude 17° 20' N and longitude 73° 15' E. The Poladpur and Kangori locate at latitude 17° 55' and 18° 01' N and longitude 73° 25' and 73° 30' E respectively. The selected spots cover with grassland, Semi evergreen forest and deciduous forest. Altitude of Kangori 754 m above the sea level and a average rainfall 3038 mm/year. Average temperature was 26°C. Biodiversity of frogs and caecilians were least known. Hence, the attempt has made on fauna of amphibian from Poladpur tehsil.

**Materials And Methods:**

The surveys were carried out during 2013-2014 in different selected spots of Poladpur Tehsil of Western Ghats, Maharashtra as a part to study of amphibian fauna. Survey were carried out mostly Karje, Umarath Poladpur and at fifteen day interval mostly during night in rainy season. We surveyed various habitats such as open land, dense forest, mixed forest and cultivated fields such as ground nut, Paddy and nachani. Studies diversity of amphibians especially Frogs, Toads, Caecilians particularly during night at ponds, Shallow streams, hilly waterfalls and moist places nearby rivers, booklets, Ponds Swamps and its nearly moist and shadow places. Only sample specimen of Unknown species carried out in laboratory for further identification.

During survey used the Nikon Camera for photographs of Frogs, Toads and Caecilians, Head torches for light, plastic bottle for collecting unknown sample specimen. After getting photographs frogs, toads and caecilians were released in their natural habitat.

**Results And Discussion:**

During this survey, we reported 13 species of amphibians belongs to 5 families and 6 genera in Poladpur Tehsil of Raigad district Western Ghats. Prasad and et al (2013) reported 37 species of amphibians belongs to 8 families 14 genera in Patan tehsil.

Chick List of Amphibian fauna of Poladpur Tehsil of Raigad District of western Ghats.

Sr. No	Amphibian Species
<b>01</b>	<b>A) Family: Ranidae Gray 1825</b>
<b>I</b>	<b>Genus :Rana Linnaeus 1758</b>
	1. <i>Rana tigerina</i> Daudin 1802
	2. <i>Rana hexcadactla</i> Lesson 1834
	3. <i>Rana beddomi</i>
	4. <i>Rana cyanophlyctis</i> Schneidr 1799
	5. <i>Rana nilgeri</i>
	6. <i>Rana temporalis</i> Gunter 1864
<b>02</b>	<b>B) Family Racophoridae Hoffman 1932</b>
<b>II</b>	Genus :Polypedates Tschudi 1838
	7. Polypedates maculates Gray 1864
<b>03</b>	<b>C) Family Bufonidae Gray 1825</b>
<b>III</b>	Genus :Bufo Laurenti 1768
	8. Bufo metanosticus Schneider 1799
	9. Bufo stomaticus Lutken 1862
<b>04</b>	<b>D.Family Microhylidae Gunter 1858</b>
<b>IV</b>	Genus Microhyla Tschudi 1838
	10. Microhyla ornate Dumeril & Bibron 1843
<b>V</b>	Genus: Uperodon Dumeril & Bibron 1843
	11. Uperodon Globulosus Gunter 1864
<b>05</b>	<b>E) Family: Ichthyophidae Taylor 1968</b>
<b>VI</b>	Genus :Ichthyophis Fitzinger 1826
	12. Ichthyopis bombayensis
	13. Ichthyophis Sp.

#### Acknowledgements:

The author is thankful to Suresh Athwale, Principal Dr. Babasaheb Ambedkar College Mahad for providing Infrastructural facilities .BPT is thankful to UGC ,Pune for providing financial support for minor research project.

#### References:

- Chanda, S.K.(2002) Hand book of Amphibians .Zoological survey of India.Kolkatta 1-350
- Daniel, J.C.(2002) The book of Indian Reptiles and Amphibians .Bom.Nat.Hist.Soc.1-238
- Dinesh K.P. C. Radhakrishnan, K.V.Gururaja, K Deuti and G.Bhatta (2011) A checklist of Amphibian of India .Online version .Zool.Survey India 1-11.
- Gururaja ,K.V(2011) Sahyadri Western Ghats Biodiversity Information system A Review list of Amphibian of the Western Ghats /wgbis.ces iisc ernet .in biodiversity /Sahyadri\_ enews /news.1-10
- Gururaja K.V. (2012) Pictorial guide to Frogs and Toads of Western Ghats .Gubbi Labs LLP. [http // www.gubbilabs.in](http://www.gubbilabs.in) .1-153.
- Myers N. and et al (2000) Biodiversity hotspots for conservation priorities. Nature 403:853-858.
- Padhy A.D., Mahabaleshwarkar and H.V.Ghate (2002) An overview of Amphibian fauna of Pune district with special reference to their status Zoo print J.17 (4):757-763.
- Sekar A.G.(1999) Key of the Amphibian fauna of Goa .Herpeton 4:3-4

## Assessment of Physicochemical Parameters of Three Hill Streams in Patan Tehsil, Satara District (M. S.) India

A.R.Padule, I. F. Pailwan and V.D.Gaikwad

Department of Zoology

Kisan Veer Mahavidyalaya, Wai

E-Mail: amrutashete290@gmail.com

### Abstract:

Hill streams in the Patan Tehsil District Satara are located in the Western Ghats. The study area is occupied with many seasonal aquatic habitats surrounded by forest and paddy fields. However very little attentions have been paid on the limnology of such seasonal aquatic habitats of hilly areas. Assessment of limnological parameters are significant to determine the ecological status of such water habitats. On present investigation the limnological parameters include temperature, pH, turbidity, total dissolve solid (TDS), total hardness, alkalinity, chlorides, dissolved oxygen (DO), and chemical oxygen demand (COD). The water quality parameters were studied for the period of three months from July 2018 to September 2018. The variations recorded are correlated with the anthropogenic activities and surrounding ecological habitats. Moreover the present study representing the scientific record of physicochemical parameters of aquatic habitats of hilly areas.

**Keywords-** Hill streams, limnological parameters, water quality.

### Introduction:

The Western Ghats, located along the southeast coastlines of the Indian subcontinent, is a biodiversity hotspots (8) and is extremely rich in its diversity as well as endemism (2, 4). And the hills in the Patan Tehsil, District Satara are the part of Western Ghats. The hilly region shows many streams which forms aquatic habitat. The quality of stream water at any point reflects several major influences, including the atmospheric inputs, climatic conditions and anthropogenic inputs (3, 15).

Water is one of the most important compound to the ecosystem, without adequate quantity and quality of fresh water sustainable development will not be possible (11, 9). The healthy aquatic ecosystem is depended on the biological diversity and physico-chemical characteristics (20). Better quality of water is described by its physical, chemical and biological characteristics. But some correlation was possible among these parameters and the significant one would be useful to indicate quality of water (18).

Water quality performs important role in health of human, animals and plants. The quality of surface water within a region is governed by both natural processes (such as precipitation rate, weathering processes and soil erosion) and anthropogenic activities (such as urban, industrial and agricultural activities and the human exploitation of water resources) (5, 6, 10). The water quality depends upon the hydrochemistry of the study area. In this view the survey was undertaken to know the physico-chemical parameters of water along the hill streams of Patan in monsoon season.

### Materials and methods:

Samples were collected from three different stations in the morning hours between 9 am to 11 am in polythene bottle regularly. The water samples were collected fortnightly in the month July to September 2018. The water samples were immediately brought into laboratory for the estimation of various physico-chemical parameters like water temperature and pH were recorded at the time of sample collection while other parameters like turbidity, total dissolve solid (TDS), total hardness, alkalinity, chlorides, dissolved oxygen (DO), and chemical oxygen demand (COD) estimated in the laboratory. These water quality parameters were studied by using standard procedures.

**Result and Discussion:** The fortnightly results of physico-chemical parameters are mentioned in table No. 2 to 4 and graphs are shown below.

Table 1: Methods used for physicochemical analysis

Sr.NO.	Parameters	Method	Unit
1.	Temperature	Laboratory Method	°C
2.	PH	Electrometric Method	-



3.	Turbidity	Nephelometric Method	NTU
4.	TDS	Gravimetric Method	mg/l
5.	Hardness	EDTA Titration Method	mg/l
6.	Alkalinity	Methyl Orange Method	mg/l
7.	Chlorides	Argentometric Method	mg/l
8.	D/O	Iodometric – Acid Modification Method	mg/l
9.	COD	Open Reflux – Titrimetric Method	mg/l

Table – 2: Analysis of water sample in July month

Sr.No.	Stations	1 July 2018			15 July 2018		
		I	II	III	I	II	III
1.	Temperature	21.40	21.70	21.50	21.80	21.70	21.50
2.	PH	7.80	8.48	7.90	7.45	7.55	7.80
3.	Turbidity	0.3	0.5	0.7	0.9	1.2	1.1
4.	TDS	70	100	120	120	140	130
5.	Hardness	30	35	37	34	46	30
6.	Alkalinity	23.50	35.25	33.40	42.30	56.40	50.15
7.	Chlorides	5.14	7.71	7.34	6.45	6.20	6.40
8.	D/O	8.15	7.99	7.34	7.45	7.40	7.80
9.	COD	1.9	2	1.7	2	1.9	1.5

Table – 3: Analysis of water sample in August month

Sr.No.	Stations	1 Aug 2018			15 Aug 2018		
		I	II	III	I	II	III
1.	Temperature	21.40	21.60	21.50	21.90	22	21.70
2.	PH	7.79	7.52	7.88	7.80	7.68	7.66
3.	Turbidity	1.9	2.6	1.8	1.7	1	1.5
4.	TDS	100	110	120	80	90	88
5.	Hardness	28	24	28	20	24	26
6.	Alkalinity	28.50	34.20	40.15	26.60	32.30	34.40
7.	Chlorides	6.17	7.20	7.10	5.14	6.17	5.6
8.	D/O	7.25	7.05	7.30	7.28	7.15	7.20
9.	COD	1.4	2	1.6	1.5	1.7	1.5

Table – 4: Analysis of water sample in September month

Sr.No.	Stations	1 Sept 2018			15 Sept 2018		
		I	II	III	I	II	III
1.	Temperature	22	22.7	22.9	23.8	23.4	23.9
2.	PH	7.30	7.50	7.80	7.40	7.48	7.88
3.	Turbidity	1.5	0.8	0.4	0.4	0.2	0.3
4.	TDS	100	120	110	82	94	152
5.	Hardness	24	26	30	28	26	52
6.	Alkalinity	32	40	38	34.20	45	49.80
7.	Chlorides	4.12	6.10	5.8	6.17	5.55	6.17
8.	D/O	7.20	7.26	7.24	7	6.70	6.80
9.	COD	1.5	1.4	1.8	1.6	1.9	1.7

**Temperature of water samples:**

Temperature range was six at which named variations from July to September at stations I, II and III. The temperature range recorded (21.40 – 23.8, 21.70 – 23.4 and 21.50 – 23.9) respectively.

**pH of water samples:** pH is another important parameter and directly influences the abundance and distribution of the organisms. In natural water pH is ranged as 5-8.5. In present study pH range recorded is

between 7.00 to 8.50 tending towards alkaline side. It was not found below 7.00. Hence suitable for the aquatic organisms.

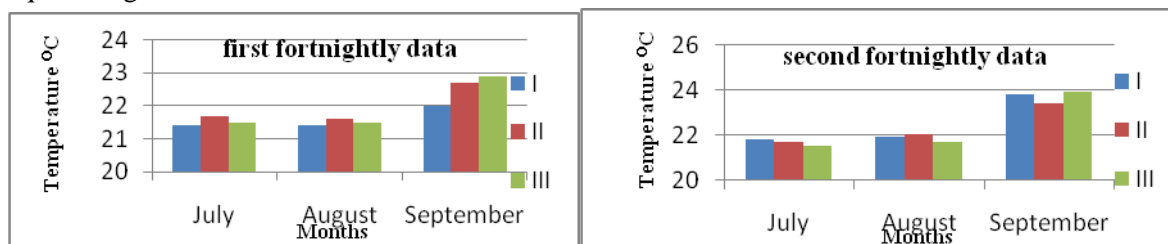

**Figure 1: Graphical presentation of temperature in three stations in July to September 2018**

### Turbidity of water samples:

Turbidity is a measure of the cloudiness/clarity of water. Cloudiness is caused by suspended solids mainly soil particles (sand, silt, clay), microscopic plants and animals that are suspended in the water column. Moderately low levels of turbidity may indicate a healthy, well-functioning ecosystem, with moderate amounts of microscopic plants and animals present to fuel the food chain. However, higher levels of turbidity pose several problems for stream systems. In present study turbidity was recorded higher in early monsoon and declined in late monsoon season.

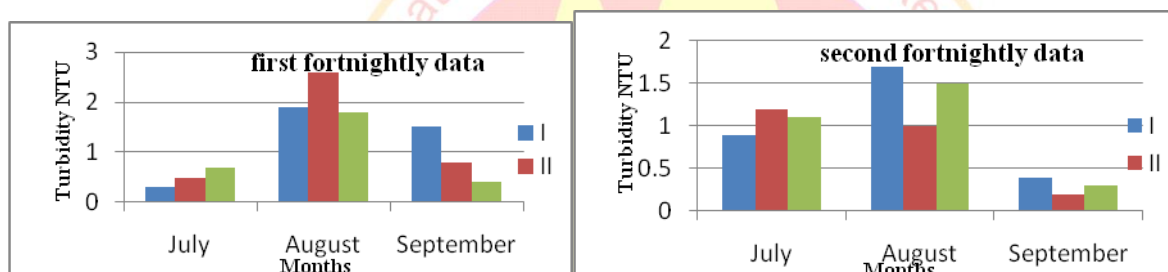

**Figure 2: Graphical presentation of turbidity in three stations in July to September 2018**

### TDS of water samples:

Total dissolved solids are the total amount of mobile charged ions, including minerals, salts or metal dissolved in a given volume of water in mg/L. TDS is directly related to the purity of water and the quality of water purification system and affects everything that consumes, lives in, or uses water, whether organic or inorganic, whether for better or for worse. Common inorganic salts that can be found in water include calcium, magnesium, potassium and sodium, which are cations and carbonates, nitrates, bicarbonates, chlorides and sulphates which are anions. In present study TDS range is increased at starting the months of monsoon and decreased in late months of monsoon.

### Hardness of water samples:

Water hardness is an aesthetic quality of water and is caused mostly by the minerals calcium and magnesium but is classified or measured based on the level of concentration of calcium. Hardness is defined as the total of soluble Calcium and Magnesium salts presents in the water medium, which is expressed as its CaCO<sub>3</sub> equivalent. The hardness range indicating soft nature of water due to little anthropogenic activities. Hardness below 75 mg/l is and indication of soft water.

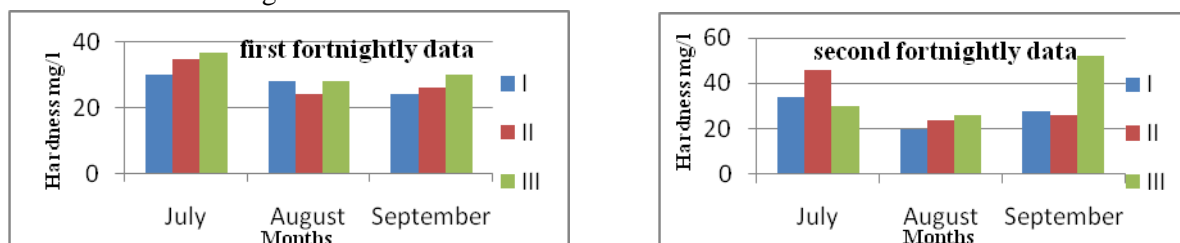

**Figure 3: Graphical presentation of hardness in three stations in July to September 2018**

### Alkalinity of water samples:

The bicarbonate alkalinity were estimated by titrimetric method as CaCO<sub>3</sub>mg/l. the carbonate alkalinity was detected by using phenolphthalein indicator and bicarbonate by methyl orange. Alkalinity is a

measure of productivity. Alkalinity range from 16.00 to 60.00 mg/l indicating moderately such in nutrients (17). Water bodies having a total alkalinity greater than 200 mg/l were found highly productive (13). Present range of alkalinity indicating towards moderate productivity of these streams. However Koushik and Saxena in 1999 has recorded alkalinity with rainfall.

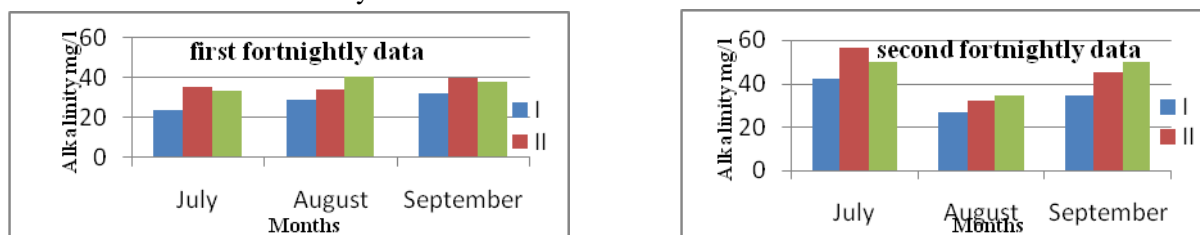

Figure 4: Graphical presentation of alkalinity in three stations in July to September 2018

### Chlorides of water samples:

Chlorides in water are due to salts of sodium, potassium and calcium. Chloride in fresh water generally remains quite low and increases by the contribution of agriculture runoff, sewage and industrial effluent. Besides, human beings and other animals exert high quantities of chlorides together with nitrogenous compounds. The chloride concentration is harmless up to 1500 mg/l though it produces salty taste at 200 - 250mg/l (19).

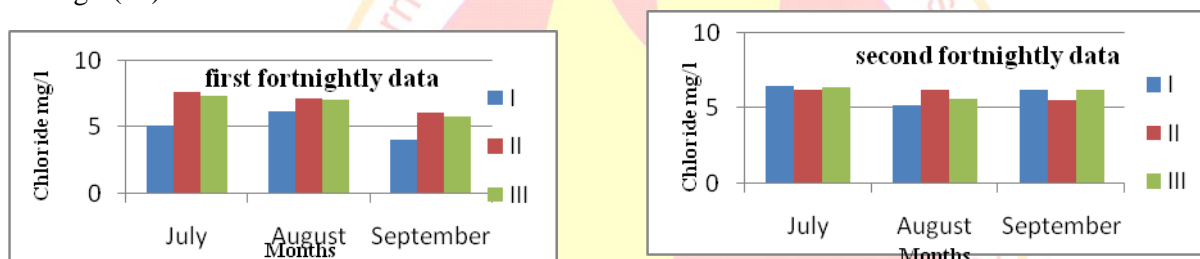

Figure 5: Graphical presentation of alkalinity in three stations in July to September 2018

### D/O of water samples:

High dissolved oxygen is an important index of clean and healthy water. Increased temperature triggers biological and chemical reaction and consequently decreases the DO. The concentration of oxygen in an aquatic environment is a function of biological process such as photosynthesis or respiration and physical processes as velocity of water and temperature. Low oxygen concentration is generally associated with organic pollution, in some cases heavy contamination may totally result in the anoxic condition. Organisms have specific requirement for DO so lower concentration may affects the survival of aquatic organisms. For healthy fresh water body at least 5 mg/l DO is essential (22). In present study DO is recorded in between 7 to 8.15. The range of dissolved oxygen is quite great in small water bodies. Kaushik and Saxena (1999) have recorded higher dissolved oxygen in monsoon due to wind and circulation of water. However the fluctuation in dissolved oxygen is regulated by photosynthetic and decomposition activities in the water bodies.

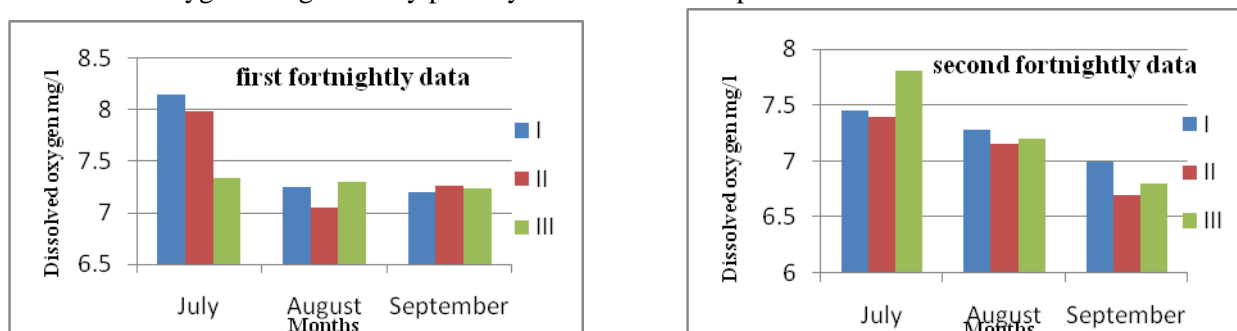
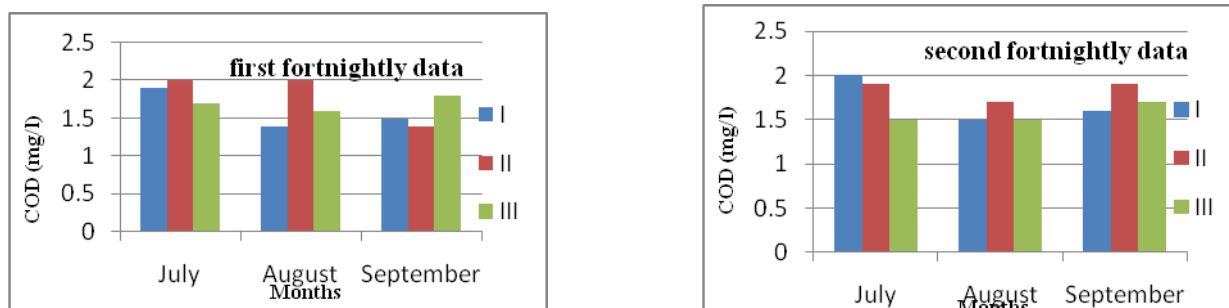

Figure 6: Graphical presentation of dissolved oxygen in three stations in July to September 2018

### COD of water samples:

. The standard method for indirect measurement of the amount of pollution in a sample of water. The chemical oxygen demand test procedure is based on the chemical decomposition of organic and inorganic

contaminants, dissolved or suspended in water. In the present investigation the recorded low value of DO and higher values of BOD and COD can be described to the discharge of effluents and non-point source of pollution in the coastal area and mangrove station(14). In present study chemical oxygen demand was recorded in between 1.4 to 2 mg/ml.



**Figure 7: Graphical presentation of COD in three stations in July to September 2018**

### Acknowledgment:

The authors are thankful to the Kisan Veer Mahavidyalay, Wai for support.

### Bibliography:

1. APHA (1979): Standard method for examination of water and waste water. American Public Health Asso. Washington D.C
2. Bhat A. 2003. Diversity and composition of freshwater fishesh in streams of central Western Ghats, India. Environmental Biology of Fishes. 68, 25-38.
3. Bricker O. P and Jones B. F. 1995. Main factors affecting the composition of natural waters, In: Salbu, B., Steinnes, E. (Eds.), Trace Elements in Natural Waters. CRC Press, Boca Raton, FL, 1-5.
4. Dahanukar N, Raut R and Bhat A. 2004. Distribution, endemism and threat status of freshwater fishes in the Western Ghats of India. Journal of Biogeography 31, 123-136.
5. Jarvie H P, Whitton B A and Neal C. 1998. Nitrogen and phosphorus in east coast British rivers: Speciation, Sources and Biological significance. Sci. Total Environ., 210-211, 79-109.
6. Kaushiks and Saxena D. N. 1999. Physicochemical limnology of certain water bodies of Central India. On – Freshwater Ecosystem of India (Ed. K. Vijaykumar) Days Publi. House, Delhi PP. 1-58.
7. Liao S W, Gau H S, Lai W L, Chen J J and Lee C G. 2007. Identification of pollution of Tapeng Lagoon from neighbouring rivers using multivariate statistical method, J Environ. Manag., 88(2), 286-292.
8. Mahavi A H, Nouri J, Babaei A A and Nabizadeh R. 2005. Agricultural activities impact on groundwater nitrate pollution. Int. J. Environ. Sci. Tech., 2(1), 41-47.
9. Mahananda M. R. 2010. Physico-chemical analysis of surface water and ground water of Bargarh District, Orissa, India. International Journal of Research and Review in Applied Sciences, 2(3), pp 284-295.
10. Manjappa S, Suresh B, Arvind H B, Puttaiah E T and Tirumala S. 2008. Studies on environmental status of Tungabhadra river near Harihar, Karnataka (India). J. Aquac. Biol, Vol 23(2), 67-72.
11. N. Kumar. 1997. A view on freshwater environment. Ecology, Environment and Conservation. Vol. 3, (3-4).
12. Nirmal K J I, George B, Kumar R N, Sajish P R and Viyol S. 2009. Assessment of spatial and temporal fluctuations in water quality of a tropical permanent estuarine system- Tapi, west coast of India. Applied Ecology and Environmental Research, 3, 267-276.
13. Noyle J. B. 1964. Some chemical factors influencing the distribution of aquatic plants in Minnesota. Amer. Midi. NaH. 3G. PP. 402-426.
14. P. Mahesh Kumar and C. Prabhakar. 2012. Physico – Chemical Parameters of River Water: A Review, International Journal of Pharmaceutical & Biological Archives; 3(6): 1304-1312.
15. Soundarapandian P, Premkumar T and Dinakaran G. K. 2009. Studies on physico-chemical characteristics and nutrients in the Uppanar estuary of Cuddalore, south east coast of India. Curr. Res. J Biol. L Sci. 1(3), 102-105.
16. Sowmyashree Shetty, N C Tharavathy, Reema Orison Lobo and Nannu Shafakatullah. 2012. Seasonal variation in the physico-chemical characteristics along the upstream of Tungabhadra river, Western Ghats, India. International Journal of Plant, Animal and Environmental Science, Vol.3, Issue-1, ISSN 2231-4490.
17. Speence D. H. N. 1964. The macrophytic vegetation of lochs swamps and associated fens. In: The Vegetation of Scotland (Ed. J. H. Burnett) Oliver and Boyd. Ednburgh PP. 306-425.
18. Sushama Pawar and Ramesh Vaidya. 2012. Studies on physico-chemical Characteristics and level of sewage pollution in Krishna river at Wai, Dist: Satara. Proceedings of International Conferences SWRDM.

19. Trivedy, R.K. and Goel,P.K. 1984. Chemical and biological methods for water pollution studies. First edition. Environmental publication, KARAD, India.
20. Venkatesharaju K, Ravikumar P, Somashekhar R. K and Prakash K. L. 2010. Physico-chemical and bacteriological investigation on the river cauvery of Kollegal Stretch in Karnataka. Journal of Science, Engineering and echnology, Vol. 6(1), PP 50-59.
21. Vijay S. Kale 2016.Consequence of Temperature, pH, Turbidity and Dissolved Oxygen Water Quality Parameters, IARJSETVol. 3, Issue 8, PP. 186-190.
22. World Health Organization (1971). International Standard for drinking water.



## Ethics in Research

**Prof. Dr. Purnima Pattanshetti.**

Department of Education,  
Rani Channama University, Belgavi, Karnatak (INDIA)  
(Chairman: Environment Session- ICEEE-2019)

Research that involves human subjects or participants raises unique and complex ethical, legal, social and political issues. Research ethics is specifically interested in the analysis of ethical issues that are raised when people are involved as participants in research.

The objectives in research ethics.

I'm a member on the ethical committee constituted by University of Science Malaysia (USM), since the last two years. Before that, a member of Ethical Committee for ICMR New Delhi for a period of five years. The experience is thought provoking and thought probing. This gives me the an urge to pen a concept article on the subject 'Ethics in Research'

As I have already said Ethics has to pervade all types of research and in all areas of disciplines, Hence it becomes important to articulate why it is important to adhere to ethical norms in research.

- One, norms promote the aims of research, such as knowledge, truth, and avoidance of error. ...
- Two, many of the ethical norms help to ensure that researchers can be held accountable to the public.

Research ethics committees have an important role to play in ensuring the ethical standards and scientific merit of research involving human subjects.

There are several important obligations placed on the ethics committee.

1. Sometimes making the right decision in the face of serious illness can be complicated. When there is uncertainty or disagreement, the \*Ethics Committee can help.
2. The Ethics Committee can help when a Medical Center staff (physicians, nurses, social workers, chaplains and others) and members of the community who are available to help patients, families, and other healthcare providers face difficult ethical decisions.
3. The Ethics Committee meets free of charge to provide a safe, supportive, confidential forum in which you and others can think through a problem, consider different points of view and sort through options.
4. Every attempt is made to involve key members of the health care team as well as the patient and family, as appropriate, in the process.
5. After discussing the ethical issues at stake, the Ethics Committee offers advice in the form of a non-binding recommendation. It is then up to those involved to decide what to do next.
6. The main obligation of the Ethics Committee is to safe guard the PRINCIPLES of ethics in any research.

They are:

1. Good consequences. Researchers shall seek to ensure that their activities produce good consequences and that any adverse consequences are within the limits of acceptability.

### 2. Quest for truth

Research activity is a quest for new knowledge, with critical and systematic verification and peer review. Honesty, openness, systematicness and documentation are fundamental preconditions for achieving this goal.

### 3. Academic freedom

Research institutions shall assist in ensuring the researchers' freedom in their choice of topic and methodology, implementation of research and publication of results. In commissioned research, the commissioning agency has the right to define the topic, research questions and scope of the research assignment in cooperation with the person or institution undertaking the assignment. The commissioning agency should not seek to unduly influence choice of methodology, implementation or publication.

### 4. Quality

Research should be of high academic quality. The researcher and institution are required to possess the necessary competence, design relevant research questions, undertake suitable choices of methodology and ensure sound and appropriate project implementation in terms of data collection, data processing and safekeeping/storage of the material.

### 5. Institutional responsibility

The responsibility for ethical conduct rests not only with the individual researcher, but also with the research institution. The institution is responsible for ensuring compliance with good academic practice and for establishing mechanisms that can address cases of suspected violations of ethical research norms.

#### 6.Honesty

Strive for honesty in all scientific communications. Honestly report data, results, methods and procedures, and publication status. Do not fabricate, falsify, or misrepresent data. Do not deceive colleagues, research sponsors, or the public.

#### 7.Integrity

The researcher is responsible for the trustworthiness of his or her own research. Fabrication, falsification, plagiarism and similar serious violations of good academic practice are incommensurate with such trustworthiness.

#### 8.reference practice

Researchers must adhere to good reference practices, which fulfil requirements for verifiability and form the basis for further research.

#### 9.Objectivity

Strive to avoid bias in experimental design, data analysis, data interpretation, peer review, personnel decisions, grant writing, expert testimony, and other aspects of research where objectivity is expected or required. Avoid or minimize bias or self-deception. Disclose personal or financial interests that may affect research.

#### 10.Carefulness

Avoid careless errors and negligence; carefully and critically examine your own work and the work of your peers. Keep good records of research activities, such as data collection, research design, and correspondence with agencies or journals.

#### 11.Openness

Share data, results, ideas, tools, resources. Be open to criticism and new ideas.

As a main rule, research results should be made available. Openness regarding research findings is essential for ensuring verifiability, for returning some benefit to the research participants and society in general, and for ensuring a dialogue with the public. Such communication is also a function of democracy.

#### 12.Respect for Intellectual Property

Honor patents, copyrights, and other forms of intellectual property. Do not use unpublished data, methods, or results without permission. Give proper acknowledgement or credit for all contributions to research. Never plagiarize.

#### 13.Confidentiality

As a general principle, those who are made the subjects of research are entitled to have their personal information treated confidentially. The researcher must prevent any use and communication of information that might inflict damage on individuals who are the subjects of research. Irrespective of the duty of confidentiality, researchers have a legal obligation to avoid punishable offences. The researcher must decide when and in what way the participant should be informed about limitations of the duty of confidentiality.

#### 14.Responsible Publication

Publish in order to advance research and scholarship, not to advance just your own career. Avoid wasteful and duplicative publication.

#### 15.reference practice

Researchers must adhere to good reference practices, which fulfill requirements for verifiability and form the basis for further research.

#### 16.Responsible Mentoring

Help to educate, mentor, and advise students. Promote their welfare and allow them to make their own decisions.

#### 17.Respect for colleagues

Respect your colleagues and treat them fairly.

#### 18.Social Responsibility

Strive to promote social good and prevent or mitigate social harms through research, public education, and advocacy.

#### 19.Non-Discrimination and Impartiality.

Avoid discrimination against colleagues or students on the basis of sex, race, ethnicity, or other factors not related to scientific competence and integrity.

Impartiality means avoidance of confusing roles and relationships in a way that may give rise to reasonable doubt concerning conflicts of interest.

**20.Competence**

Maintain and improve your own professional competence and expertise through lifelong education and learning; take steps to promote competence in science as a whole.

**21.Legality**

Know and obey relevant laws and institutional and governmental policies.

**22.Animal Care**

Show proper respect and care for animals when using them in research. Do not conduct unnecessary or poorly designed animal experiments.

**23.Human Subjects Protection**

When conducting research on human subjects, minimize harms and risks and maximize benefits; respect human dignity, privacy, and autonomy; take special precautions with vulnerable populations; and strive to distribute the benefits and burdens of research fairly.

**24.Voluntary informed consent**

Consent is the main rule in research on individuals or on information and material that can be linked to individuals. This consent should be informed, explicit, voluntary and documentable. Consent presupposes the capacity to give such consent. To ensure real voluntariness, vigilance must be exercised in cases where the participant is in a dependency relationship to the researcher or in a situation of restricted freedom.

**How Ethical Committees look at the CASE STUDIES?****1.Case Study: May I video the class?**

The researchers wanted to use participant-generated video to explore the experience of design students at university. Students would be invited to use a camera to record aspects of their life at university. They were keen to ensure students did not feel coerced to participate, or to falsify or distort data to appease university staff or the researchers.

The researchers agreed that: no student involved in video data gathering would be identified to the faculty; students would be paid for the work that they were doing; the final report would be distributed only to senior staff in the faculty, so that no lecturer could guess the identity of the students; lecturers would be notified in advance of the study and of the possibility that students might approach them for permission to interview them or film in classes.

- 1) Should the identity of those who are filming and those who are being filmed be protected and, if so, how would you do this?
- 2) Whose consent might be needed?
- 3) Should students be paid for this work and, if so, at what rate?
- 4) What might the impact be on students who were unwilling to be video recorded in class? How might you minimise risks to them?

Keywords: participant-generated video; anonymity; consent; compensation; insider research.

**2. Case Study: How do you use data on students?**

Your university has recently upgraded its learning management system which will enable a larger set of learning analytics to be made available to different parts of the institution. This set might also be linked to other data sets. The Student Association and the academics' union have asked the university to clarify what data might be made available, under what circumstances, in what form and for what purposes.

- 1) What would be good practice?
- 2) What ethical issues exist in relation to
  - a. collection of the data?
  - b. the interpretation of data?
  - c. storage of the data?

Keywords: learning analytics; data linkage; data mining; data security





**Conclusion:**

Our discussion may well have given the impression that the activity of doing educational research is saturated with agonizing ethical dilemmas. It is certainly true that any research project involves many potential ethical issues. However, these are by no means always very serious matters about which researchers need to worry or deliberate. Our view is that there is often a tendency to over-dramatise the seriousness of the ethical problems involved in social and educational research. For example, much of the time this research has relatively little significance for the people being studied, compared with all the other things going on in their lives. Indeed, it seems to us that, in ethical terms, social and educational research is not much different from many ordinary activities that we all engage in every day. There too there is always scope for identifying ethical issues that might need consideration. Much of the time these will have to be put on one side in order to get anything done, but some of them will be of such importance that they need to be addressed. Careful discrimination is required.

It certainly seems to us that the sorts of ethical issues that arise in doing social and ethical research do not usually have the same level of seriousness as those involved in, say, carrying out randomised trials on the effectiveness of medical treatments. Here, the consequences for those being researched are likely to be potentially much more severe, though the benefits may also be greater. Indeed, we do not believe that even randomised controlled trials of educational interventions involve the same level of serious problems as those in medicine; though, as in the case of educational action research, there will always be issues to do with the nature and consequences of the intervention concerned. Generally speaking, research which does not involve any major intervention in the lives of the people being studied is less likely to generate serious ethical issues. While there will be some occasions when major problems do arise, in our judgment these are not very common. Needless to say, our views on this matter are far from universally shared by educational researchers or by other stakeholders. However, this fact simply underscores what has been one of our main points here: that there is considerable room for reasonable disagreement about research ethics.

**References:**

1. Campbell, H. and R. Marshall (2000). "Moral obligations, planning, and the public interest: a commentary on current British practice.
2. Campbell, H. and R. Marshall (2002). Values and professional identities in planning practice. Planning futures. New directions for planning theory. P. Allmendinger and M. Tewdwr-Jones. London, Routledge.
3. Bulmer, M., Ed. (1982). Social research ethics: an examination of the merits of covert participant observation. London, Macmillan.
4. Bulmer, M. (2001). The ethics of social research. Researching Social Life. N. Gilbert. London, Sage: 45-57.
5. Guterman, L. (2006). "Digging Into the Roots of Research Ethics." The Chronicle of Higher Education 53(2).
6. HMSO (1998). Data Protection Act. UK.